

## Article

# The Development of a Measuring System for Intraoral SpO<sub>2</sub>

Yuki Kashima <sup>1,\*</sup>, Minako Onimaru <sup>1</sup> , Ryosuke Isogai <sup>2</sup>, Noboru Kawai <sup>2</sup>, Yoshifumi Yoshida <sup>2</sup> and Koutaro Maki <sup>1</sup>

<sup>1</sup> Department of Orthodontics, School of Dentistry, Showa University, 2-1-1 Kitasenzoku, Ota-ku, Tokyo 145-8515, Japan; onimaru@dent.showa-u.ac.jp (M.O.); maki@dent.showa-u.ac.jp (K.M.)

<sup>2</sup> Research and Development Department, Seiko Future Creation Inc., 563, Takatsuka Shinden, Chiba 270-2222, Japan; yoshifumi.yoshida@seiko-sfc.co.jp (Y.Y.)

\* Correspondence: kashima-y@dent.showa-u.ac.jp; Tel.: +81-3-3787-1151

**Abstract:** Blood oxygen saturation (SpO<sub>2</sub>) is an essential indicator of a patient's general condition. However, conventional measurement methods have some issues such as time delay and interference by ambient light. Improved measurement methods must be developed, and there are no reports on intraoral measurements of SpO<sub>2</sub> using wearable devices. Therefore, we aimed to establish an intraoral SpO<sub>2</sub> measurement method for the first time. Twelve healthy adults participated in this study. The following steps were taken: (1) to identify the optimal measurement location, mid-perfusion index (PI) values were measured at six places on the mucosa of the maxilla, (2) to validate the optimal measurement pressure, PI values were obtained at different pressures, and (3) using the proposed mouthpiece device, SpO<sub>2</sub> values in the oral cavity and on the finger were analyzed during breath-holding. The highest PI values were observed in the palatal gingiva of the maxillary canine teeth, with high PI values at pressures ranging from 0.3 to 0.8 N. In addition, changes in SpO<sub>2</sub> were detected approximately 7 s faster in the oral cavity than those on the finger, which is attributed to their proximity to the heart. This study demonstrates the advantage of the oral cavity for acquiring biological information using a novel device.

**Keywords:** pulse oximetry; mouthpiece; pulse rate; oxygen saturation monitoring; wearable monitoring system; SpO<sub>2</sub>



**Citation:** Kashima, Y.; Onimaru, M.; Isogai, R.; Kawai, N.; Yoshida, Y.; Maki, K. The Development of a Measuring System for Intraoral SpO<sub>2</sub>. *Sensors* **2024**, *24*, 435. <https://doi.org/10.3390/s24020435>

Academic Editor: Marc Parrilla

Received: 30 October 2023

Revised: 5 January 2024

Accepted: 8 January 2024

Published: 10 January 2024



**Copyright:** © 2024 by the authors. Licensee MDPI, Basel, Switzerland. This article is an open access article distributed under the terms and conditions of the Creative Commons Attribution (CC BY) license (<https://creativecommons.org/licenses/by/4.0/>).

## 1. Introduction

In recent years, the acquisition and management of biometric information using wearable devices has become common. Blood oxygen saturation (SpO<sub>2</sub>), indicating the oxygen supply to the human body, is one of the main items detected by wearable devices. It is indispensable for monitoring vital organs such as the heart and brain. SpO<sub>2</sub> measurements are currently used in many situations, such as checking vital signs during exercise, monitoring the condition of older patients, and monitoring sick and hospitalized patients [1,2].

There are two types of SpO<sub>2</sub> sensors: transmissive sensors that are attached to the fingers and toes and reflective sensors that are fixed by applying light pressure to the forehead or other parts of the body [3]. Transmissive sensors use a light source and a detector positioned across the measurement site or living tissue. Their advantages include rapid use and the ability to easily sample various parts of the body, even with low-amplitude signals. Reflective sensors use the light source and detector positioned on the same side of the living tissue. In cold environments, human arteries constrict to preserve body heat, minimizing heat loss. Consequently, in transmission-type devices, a signal decline from arterial capillaries impairs measurement accuracy. This issue is avoided in reflection-type pulse oximeters, where the sensor (comprising LEDs and a photodetector) can be positioned near any body part [4,5]. In general, transmissive SpO<sub>2</sub> sensors worn on the hand are widely used because they are considered to be easy to install and use. However, they have six major problems as outlined below.

1. Time delay in measurements: There is a time delay associated with measurements taken at the periphery of the body, such as the fingers, which makes it difficult to detect sudden changes in pathological conditions in real time [6].
2. Dependence on blood flow: When blood flow decreases because of insufficient peripheral circulation, such as during hypothermia, it is difficult to obtain sufficiently strong signals [7].
3. The influence of body movement: Body movement during sports or sleep causes the device to shift, which significantly affects the measurement accuracy [8].
4. Location: Many conventional devices are worn on the surface of the body, which is difficult to accomplish in cases where the patient has burns or sensitive injuries [9].
5. The influence of pressure: Accurate measurement is impossible without using the optimal contact pressure [10]. If the pressure of the sensor on the human body is insufficient, the amplitude of the AC signal is reduced, making it difficult to detect transmitted light. Conversely, when excessive pressure is applied, the waveform of the AC signal is distorted by the occluded artery, which also affects the accuracy [11].
6. The influence of visible light: Interference from visible light in the surroundings can affect the accurate detection of the desired light signals [12].

To overcome the shortcomings of conventional pulse oximeters, several studies have reported on the measurements of SpO<sub>2</sub> at various sites, such as the external auditory canal [13], intestine [14], and esophagus [15]. However, no previous reports have completely solved the problems mentioned above. Therefore, it remains necessary to establish a measurement method at a site where stable and accurate measurements can be obtained.

Herein, we propose a measurement method that solves the above problems by mounting the device on a mouthpiece, referred to as an intraoral device. Since the oral cavity is close to the heart, there is little time delay in the SpO<sub>2</sub> measurement, and blood flow is always abundant. The mouth is also dark and is not affected by ambient light to a significant extent. In addition, SpO<sub>2</sub> is conventionally measured through the epidermis, dermis, and subcutaneous tissue, using a skin-mediated method. However, there are more blood vessels in the oral mucosa than in the skin [16,17]. Therefore, blood flow is not only abundant and easy to measure, but the measured values may also represent the blood oxygen concentrations inside the body more accurately.

Furthermore, mouthpieces are widely used for orthodontic treatment and can be easily put on and taken off [18]. Thus, an example of its application in intraoral sensing has been reported [19,20]. Notably, this type of device is unlikely to shift because of body movement, because it is stabilized within the oral cavity. However, the oral cavity is a moist environment, making it necessary to consider waterproofing. Additionally, conventional transmissive pulse oximeters cannot be used because biological tissue cannot be easily confined in the measuring instrument, and the effects of pressure are unknown. For these reasons, measuring SpO<sub>2</sub> in the oral cavity has been challenging.

Therefore, we developed a waterproof reflective SpO<sub>2</sub> sensor, which represents the first intraoral SpO<sub>2</sub> measurement method using a mouthpiece-type device. We also verified the optimal measurement site and pressure.

## 2. Materials and Methods

### 2.1. Principles of Measurement

#### 2.1.1. Pulse Oximeter

The pulse oximeter is based on the principle that oxygenated hemoglobin molecules (HbO<sub>2</sub>) and deoxygenated hemoglobin molecules (Hb) absorb different amounts of red and near-infrared (IR) light [3]; HbO<sub>2</sub> absorbs a larger amount of IR light and a smaller amount of red light than Hb. Pulse oximeters emit two wavelengths of light from a small light-emitting diode: generally red light at 660 nm and near-IR light at 940 nm. In a transmission-type device, the light transmitted through the sample is detected using a photodiode (PD) placed on the opposite side. In a reflection-type device, the PD detects the reflected light from the body tissue [11].

### 2.1.2. Perfusion Index (PI) Value

The detected optical signal can be separated into a pulsatile (AC) signal that fluctuates with the pulse wave and a non-pulsatile (DC) signal that does not fluctuate (Figure 1). The AC/DC signal ratio expressed is called the perfusion index (PI) value. The PI value is used in the field of pulse oximetry as an indicator of measurement stability [21] and indicates the immediate perfusion state of the tissue in the area of application at regular time intervals. Higher PI values indicate a stable measurement because of the state of high tissue perfusion. When the PI value is small, the state of tissue perfusion is low, making the measurement susceptible to noise and reducing the accuracy of SpO<sub>2</sub> measurements [22].

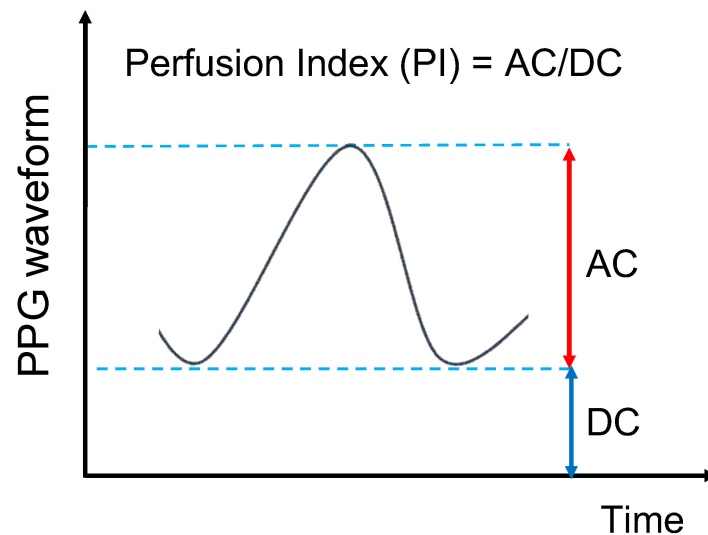

**Figure 1.** Schematic diagram of AC and DC signals.

## 2.2. Intraoral Sensing Modules

### 2.2.1. Sensing Module and Measurement System

In this study, the measurement system consists of sensing modules (SpO<sub>2</sub> and pressure sensors), an external control board, and a computer. Figure 2 shows a block diagram of the measurement system. The SpO<sub>2</sub> sensor consists of two light-emitting diodes (LEDs) (660 and 880 nm, MAXM86161, Analog Devices, Cambridge, MA, USA). The measurement condition of SpO<sub>2</sub> is listed in Table 1. The pressure sensor (HSFPAR303A, Alps Alpine Co., Ltd., Tokyo, Japan) is a load sensor with a piezoresistor formed on a silicon diaphragm. This sensor utilizes the piezo-resistive effect, in which stress is generated in the piezoresistor by the flexure of the diaphragm when a load is applied, resulting in a change in resistivity. In addition, the pressure sensor is given a protrusion to enable more accurate pressure measurements compared with surface-type pressure sensors. Figure 3 shows a sensing module and its design diagram. The module consists of an optical sensor and a pressure sensor, which measure light intensity and SpO<sub>2</sub>, while also measuring the mechanical pressure (Figure 3a,b). The compact design of the module (SpO<sub>2</sub> sensor: height of 6.5 mm, width of 8.0 mm, depth of 3.0 mm; pressure sensor: height of 6.5 mm, width of 8.0 mm, depth of 2.06 mm) makes it easy to follow the individual's palate (Figure 3d,e). Furthermore, the wiring between the sensor and connector was formed using a flexible printed circuit, allowing installation from the mouth to any intraoral location. The sensing module is connected to an external control board by a cable and controlled using a microcontroller via a twin-wire interface. Figure 4 shows the waterproof structure of the sensor. The sensor is coated with parylene and silicone to provide a double waterproof structure. However, the SpO<sub>2</sub> sensor is exposed to prevent the optical absorption of silicone.

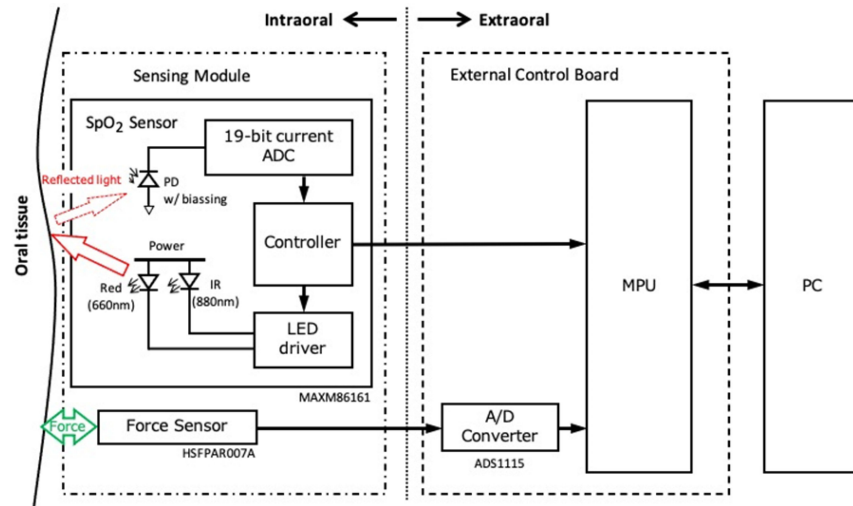

Figure 2. Block diagram of the SpO<sub>2</sub> measurement system. MPU, microprocessor; PC, personal computer.

Table 1. SpO<sub>2</sub> sensor condition.

LED wavelength (nm)	660 for red, 880 for IR
LED current (mA)	7 for red and IR
LED radiation power (mW)	Approx. 3.2 for red, 2.7 for IR
Sampling rate (sps)	50
Averaging (pts)	2 * <sup>1</sup>
LED pulse width (μs)	123.8
LED settling time (μs)	12 * <sup>2</sup>
Photodiode (PD) spectral bandwidth (nm)	420 to 1020 (860 nm at peak)

\*<sup>1</sup> A sampled PD intensity was averaged for the noise reduction to output 25 final values per second (50 sps/2 ave).  
 \*<sup>2</sup> Delay from the rising edge of the LED to the start of analog–digital conversion, which allows for the LED current to be stabilized.

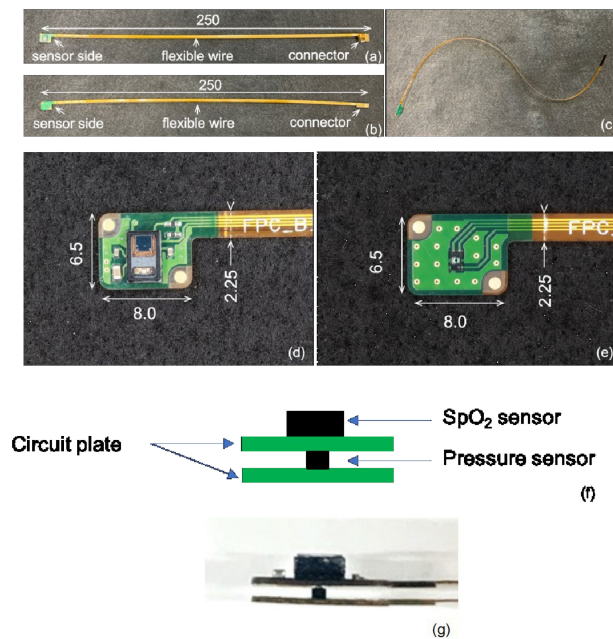
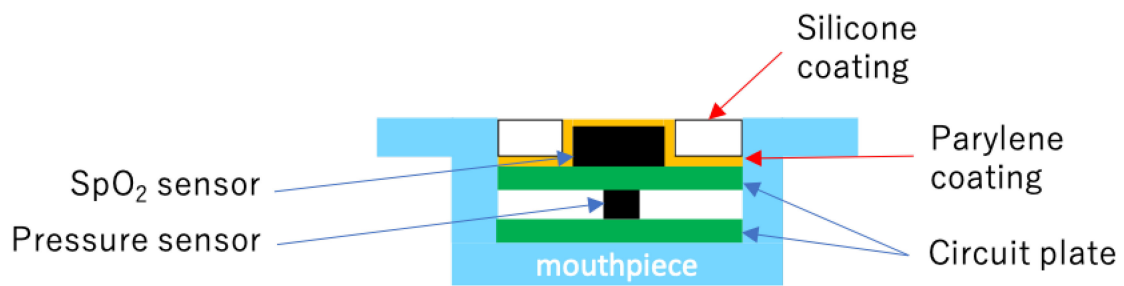

Figure 3. The sensor module. (a) Photograph of the SpO<sub>2</sub> sensor. (b) Photograph of the pressure sensor. (c) Photograph of sensor wiring in the bent state. (d) Magnified view of the SpO<sub>2</sub> sensor. (e) Magnified view of the pressure sensor. (f) Schematic diagram of the side view of the SpO<sub>2</sub> sensor and pressure sensor. (g) Side view of the SpO<sub>2</sub> sensor and pressure sensor.



**Figure 4.** Schematic diagram of the waterproof structure.

### 2.2.2. Method of Manufacturing the Mouthpiece Device

Mouthpieces equipped with SpO<sub>2</sub> sensors need to be custom-made for each subject. To do this, first, optical impressions of the maxilla were taken (TRIOS, 3Shape, Copenhagen, Denmark) and reconstructed using a 3D printer (AGILISTA, KEYENCE, Osaka, Japan) to create a mold. An 8.0 mm × 6.5 mm × 1.0 mm sensor storage spacer was bonded to the palatal gingival portion of maxillary #3, and a 0.80 mm mouthpiece sheet material (Erkodur; Erkodent Erich Kopp GmbH, Pfalzgrafenweiler, Germany) was placed in a vacuum thermoforming unit (Erkopress ci motion; Erkodent Erich Kopp GmbH) and thermoformed. Then, the mouthpiece was removed from the dental model and modified again (Figure 5).

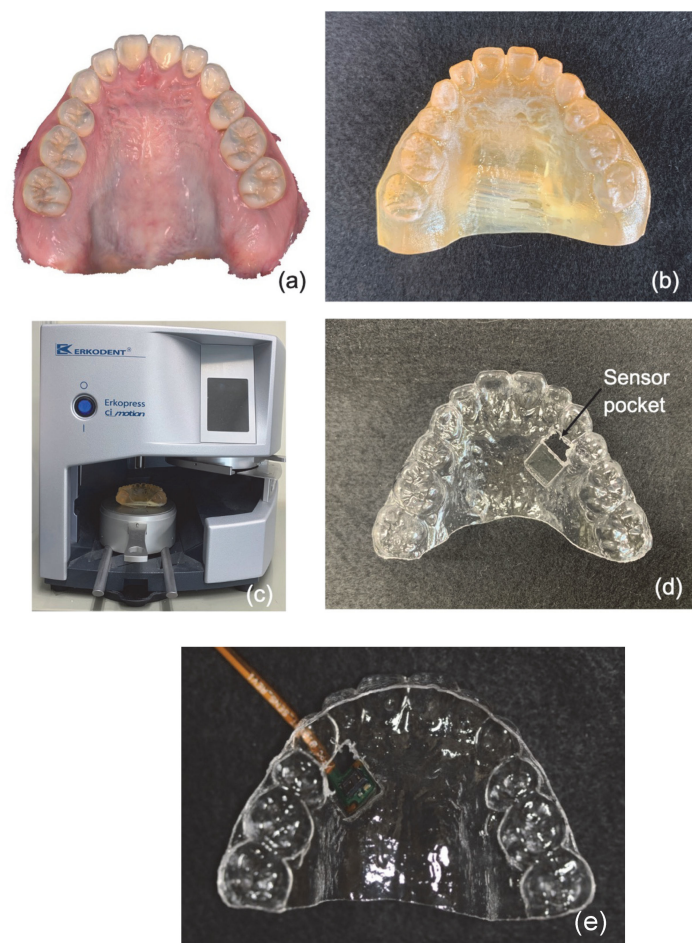

**Figure 5.** Manufacturing method of the mouthpiece-type SpO<sub>2</sub> analyzer. (a) Optical impression data of the teeth; (b) a tooth model fabricated with a 3D printer; (c) after bonding the spacer to the palatal gingival area of maxillary #3, the mouthpiece seat material is attached; (d) the completed mouthpiece; (e) the interior of a mouthpiece with attached sensors.

### 2.3. Measurement of SpO<sub>2</sub>

#### 2.3.1. Verification of the Mouthpiece Device (Extraoral)

The verification equipment is capable of verifying a transmission-type pulse oximeter. Therefore, we decided to verify the accuracy by employing a pulse oximeter whose accuracy was verified by the verification device.

We evaluated the accuracy of the pulse oximeter (PVM-2701, Nihon Kohden, Tokyo, Japan) in advance using the validation device (vPad-A1, Metts, Tokyo, Japan) and confirmed that there were no problems with accuracy. The pseudo-signal of light transmitted through living tissue, such as a fingertip, emitted from the verification device was read by the pulse oximeter. We verified whether the value was the same as the vital sign of the validation device.

The PVM-2701 pulse oximeter was then attached to the middle finger of the right hand, while the developed SpO<sub>2</sub> sensor was grasped with the index finger of the right hand so that it contacted the palm surface. SpO<sub>2</sub> values were simultaneously monitored using the two sensors for 30 s (Figure 6). Bland–Altman analysis was performed to determine the agreement between the developed SpO<sub>2</sub> sensor and the commercial pulse oximeter [23,24]. JMP Pro<sup>®</sup> 16.0.0 software (SAS Institute Inc., Cary, NC, USA) was used for all statistical analyses.

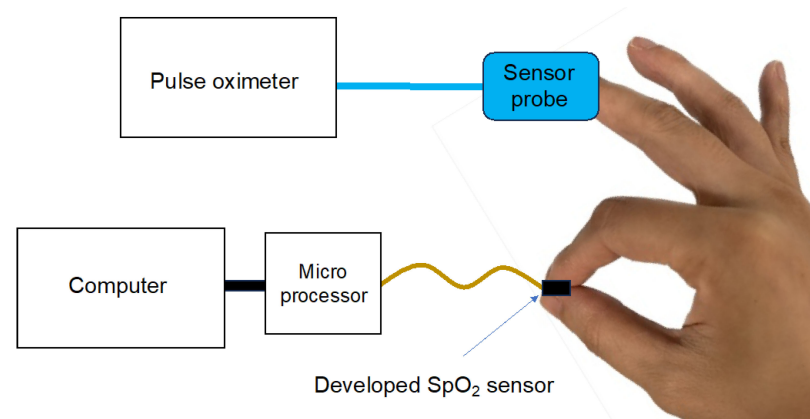

**Figure 6.** Accuracy evaluation of the developed SpO<sub>2</sub> measurement device. The pulse oximeter is attached to the middle finger and the SpO<sub>2</sub> sensor is grasped by the index finger.

#### 2.3.2. Accuracy Evaluation of the Mouthpiece Device (Intraoral and Extraoral)

The developed SpO<sub>2</sub> sensor was used to monitor the oral cavity and finger at rest for 30 s. The developed SpO<sub>2</sub> sensor was attached to a mouthpiece and placed in the oral cavity (Figure 7), while another device was held with the index finger of the right hand so that the developed SpO<sub>2</sub> sensor was in contact with the palm surface. Bland–Altman analysis was performed to determine the agreement between the two monitoring sites.



**Figure 7.** Intraoral view of the mouthpiece with the attached sensor.

### 2.3.3. SpO<sub>2</sub> and Pressure Measurements at Different Locations (Intraoral)

Using devices constructed for six healthy adult volunteers, SpO<sub>2</sub> was measured at the six intraoral locations shown in Figure 8 while changing the contact pressure. The PI values were also obtained.

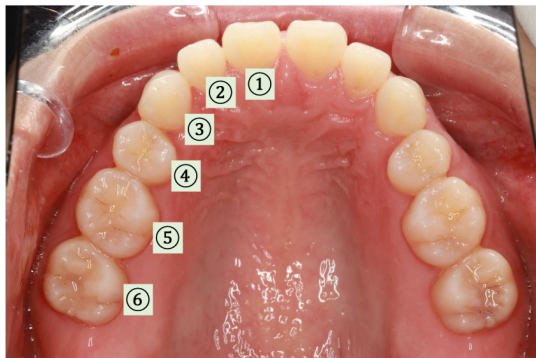

**Figure 8.** Measurement sites in the oral cavity. Sensors were placed at locations 1 to 6 to obtain the SpO<sub>2</sub> and perfusion index (PI) values. Placing the sensor on the buccal side is generally painful; thus, it was only placed on the palatal side, which is less painful. (1) Central incisor. (2) Lateral incisor. (3) Canine tooth. (4) Pre-molar. (5) Lateral first molar. (6) Second molar.

### 2.3.4. Breath-Holding Measurements Using the Mouthpiece Device (Intraoral and Extraoral)

Twelve healthy adult volunteers participated in this study. They had normal occlusion and no history of oral or maxillofacial disease or extreme trauma. All subjects were seated in a chair at rest. The mouthpiece device was placed in the oral cavity while another device was held with the index finger of the right hand so that the developed SpO<sub>2</sub> sensor was in contact with the palm surface. The device used for measurements was the same for both the oral cavity and the fingers. After normal breathing was continued from the start of measurement, breath-holding was performed from the state of exhaled breath. After holding the breath within a comfortable range, the subject resumed breathing. Once the SpO<sub>2</sub> value recovered, the measurement was terminated. Breath-holding was performed to simulate a hypoxic condition conveniently [25]. Measurements were taken three times per subject. The normality of the SpO<sub>2</sub> values obtained from the oral cavities and fingers based on their lowest point, was verified using the Shapiro–Wilk test. For normally distributed values, a paired *t*-test was used, and for non-normally distributed values, a Wilcoxon signed-rank test was used.

## 3. Results

### 3.1. Accuracy of the Mouthpiece Device (Extraoral)

Bland–Altman analysis was performed to compare the corresponding SpO<sub>2</sub> values obtained from the developed SpO<sub>2</sub> sensor and commercial pulse oximeter. There was no significant difference between the measured values and the mean. The limits of agreement were 0.928 to −0.124. Therefore, the developed SpO<sub>2</sub> sensor and pulse oximeter obtained similar measurements, and there were no problems with the accuracy of the developed SpO<sub>2</sub> sensor.

### 3.2. Accuracy of the Mouthpiece Device (Intraoral and Extraoral)

From the Bland–Altman analysis, SpO<sub>2</sub> values obtained from the finger were compared with those obtained from the mouth using the developed SpO<sub>2</sub> sensor. There was no significant difference between the measured values and the mean. The limits of agreement were 0.241 to −0.694. Thus, there was no significant difference between the SpO<sub>2</sub> values obtained from the finger and mouth at rest.

### 3.3. Evaluation of Measured Values Obtained Using the Mouthpiece Device

#### 3.3.1. SpO<sub>2</sub> and Pressure (Intraoral)

The PI values obtained for each measurement site are shown in Figure 9. The PI value for the palatal gingiva of the maxillary canine was the highest, and the PI value for the palatal gingiva of the maxillary premolar was the lowest. The average PI values for all six sites at different pressures are shown in Figure 10. The PI values were relatively high in the pressure range of 0.3–0.8 N.

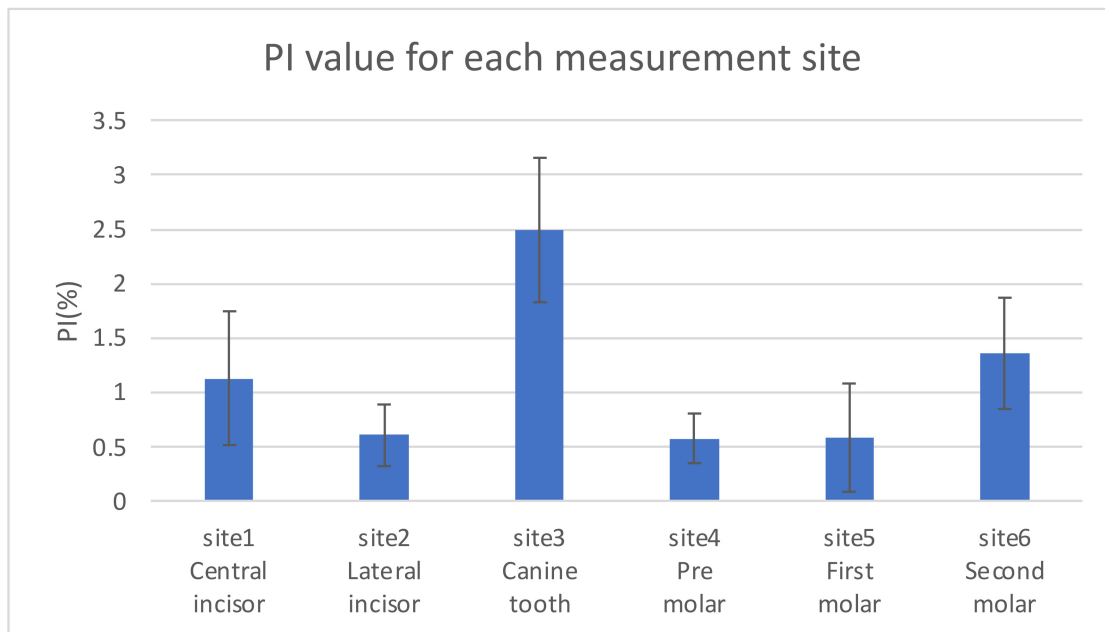

**Figure 9.** PI value for each measurement site.

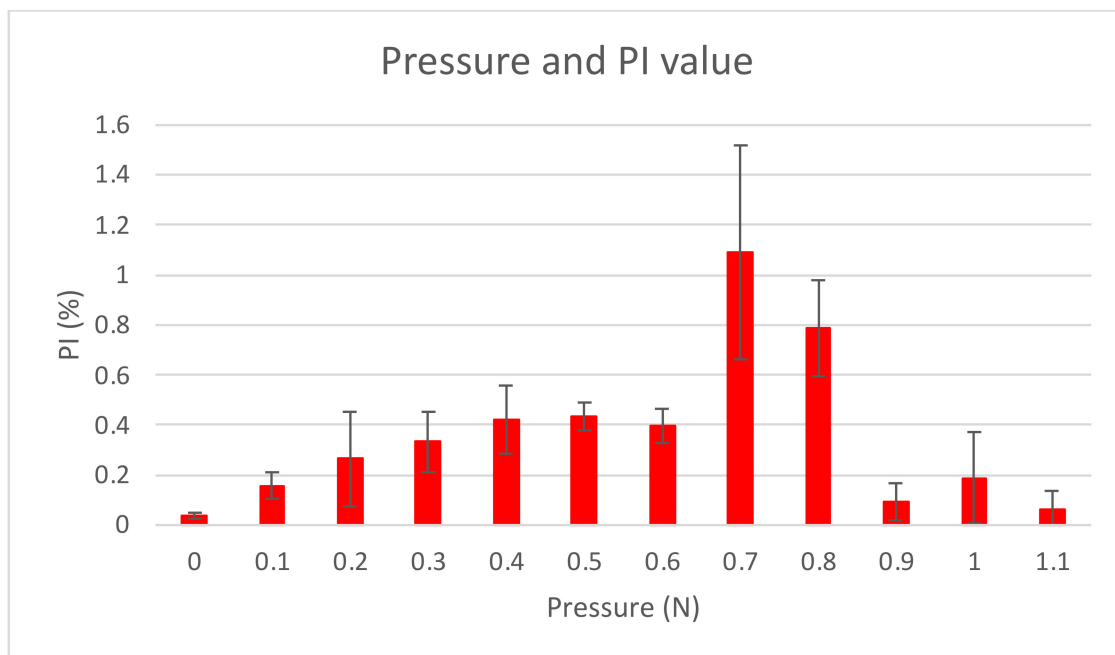
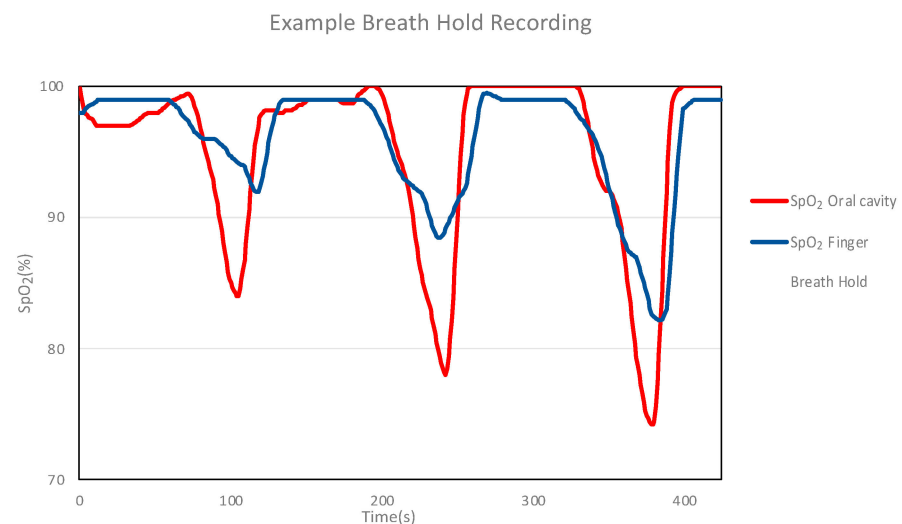

**Figure 10.** Relationship between pressure and the PI value.



### 3.3.2. Breath-Holding and SpO<sub>2</sub> Response (Intraoral and Extraoral)

An example of the results obtained for the mouth and finger using a mouthpiece SpO<sub>2</sub> measurement device is shown in Figure 11. The measurements in the oral cavity are more responsive and exhibit lower values than those performed using the finger. During breath-holding, the time(s) of the measurement response for the oral cavity and finger was evaluated. The time during measurement was classified into four segments (T1–T4), as shown in Figure 12. The lowest SpO<sub>2</sub> value (% of baseline) was also evaluated for the oral cavity and fingers during breath-holding.



**Figure 11.** SpO<sub>2</sub> values obtained from the oral cavity and finger using a mouthpiece SpO<sub>2</sub> measuring device. SpO<sub>2</sub> values obtained from the mouth and fingers using a mouthpiece SpO<sub>2</sub> measuring device. The light blue area is the respiratory arrest zone.

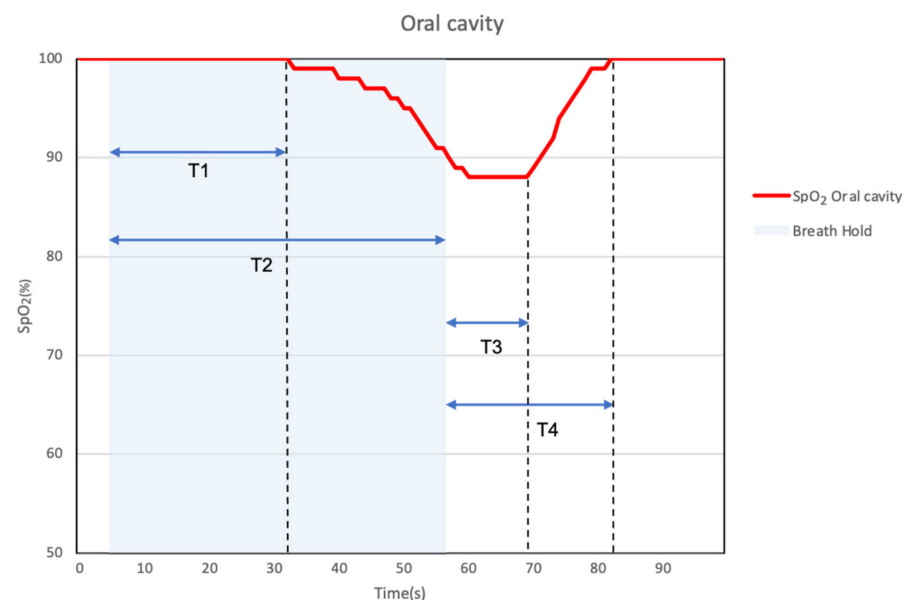

**Figure 12.** Schematic diagram of SpO<sub>2</sub> values obtained using the developed SpO<sub>2</sub> sensor. The time segments are classified as follows. T1: Time from respiratory arrest to the beginning of SpO<sub>2</sub> decrease. T2: Time from respiratory arrest to the lowest point of SpO<sub>2</sub>. T3: Time from resuming respiration to the start of SpO<sub>2</sub> recovery. T4: Time from resuming respiration to the completion of SpO<sub>2</sub> recovery.

Table 2 summarizes the time evaluations (T1–T4) comparing oral cavity and finger measurements during breath-holding. This represents the time difference between the

response measured in the oral cavity and the response measured on the finger. All T1–T4 periods showed significant differences ( $p < 0.05$ ), indicating that oral cavity measurements are more responsive than finger measurements. On average, the oral cavity responded about 7 s (18%) earlier than the fingers across T1–T4.

**Table 2.** Statistical results of T1–T4 for the mouthpiece device.

	Evaluation of Time, T1–T4		<i>p</i> -Value
	Mean Value (Second)	SD	
T1	7.4	2.8	0.01 *
T2	7.3	2.3	0.004 *
T3	7.4	1.6	<0.0001 *
T4	6.5	1.9	0.002 *

\* *p*-value < 0.05 was considered significant.

In Table 3, the results for the lowest SpO<sub>2</sub> values are presented. Significant differences were observed ( $p < 0.05$ ), with the oral cavity showing a lower SpO<sub>2</sub> value than the finger. The lowest SpO<sub>2</sub> value measured in the oral cavity showed a 4% difference compared to the value measured on the finger.

**Table 3.** Statistical results for the difference in the lowest SpO<sub>2</sub> values between the oral cavity and fingers.

	Mean Value (%)	SD	<i>p</i> -Value
Lowest point	4.0	0.9	0.0002 *

\* *p*-value < 0.05 was considered significant.

#### 4. Discussion

Differences in PI values were observed due to different measurement locations in the oral cavity. These differences are attributable to the anatomical structure of the oral cavity, such as the distribution of arteries and blood vessels. Especially on the lingual side of the canine teeth, the major palatine artery runs close to the teeth, and the mucosa is thicker compared to other parts of the mouth [26,27], resulting in more abundant blood flow. Accordingly, the PI value was higher and more stable on the canine palatal side, site 3. The lowest PI values were observed at sites 4 and 5, which may be explained by the thinner mucosa in the molars, where the blood supply was lower. The reason for the low PI value at sites 1 and 2 is considered to be the unevenness of the palatal folds. Even though blood flow is abundant from the nasopalatine canal artery, the curve of the palate may have prevented even contact pressure with the sensor. Although site 6 was located closest to the major palatine artery, the mucosa was thinner than that at site 3, contributing to a lower PI value.

In addition, one of the critical factors for stable sensing is the comfort of the subject, which must be considered to avoid reflective unconscious tongue movement and sensor displacement. To reduce discomfort and avoid tongue interference, the sensor should be set in close proximity to the teeth. In terms of comfort, blood supply, and accurate measurements, the canine teeth are the most appropriate site for measuring SpO<sub>2</sub> in the oral cavity.

Regarding the effect of pressure, high PI values were observed at 0.3–0.8 N. In a previous study, in which PI values were examined by changing the pressure between the sensor and the measurement site (finger) on the skin, the PI value reached maximum values at 0.2–0.8 N [28]. This result is consistent with the results of the present experiment, despite the differences between skin and mucous membranes. However, a future challenge lies in the potential for pressure fluctuations and instability in measurements due to tongue interference. Therefore, it is essential to exercise caution during measurements to ensure that the tongue does not exert pressure on the sensor.

The contact pressure between the SpO<sub>2</sub> sensor and the oral cavity varies according to shape, but the shape of the palate differs from person to person and the pressure could not be varied precisely according to shape. The SpO<sub>2</sub> sensor and pressure sensor were superimposed so that the pressure with which the SpO<sub>2</sub> sensor contacts the oral cavity can be measured quantitatively. In case of insufficient pressure, the amplitude of the AC signal decreases owing to insufficient contact with the sensor. Conversely, excessive pressure may reduce the amplitude of the AC signal and distort the waveform [11]. Thus, it is necessary to determine the minimum pressure required to accurately measure SpO<sub>2</sub>.

The results obtained during breath-holding suggest that the oral cavity sensor can detect a drop in SpO<sub>2</sub> approximately 7 s (18%) earlier than the finger sensor, and the lowest SpO<sub>2</sub> value was approximately 4% more acutely detected in the oral cavity than that obtained on the finger when breath-holding stopped. The reason for this is that the oral cavity is closer to the central vascular system and lungs than the fingers and other terminal organs. Therefore, the time for arterial blood to reach the measurement site is shorter for the mouth than for the finger. Furthermore, compared with peripheral arteries, there is no vasoconstrictive response, and blood with a lower oxygen concentration may reach the mouth more quickly than the finger. The significant decrease in SpO<sub>2</sub> observed in the oral cavity can be attributed to the proximity of the oral cavity to the lungs compared to the fingers. It is hypothesized that blood with a lower oxygen concentration reaches the measurement site more readily in the oral cavity than in the fingers. A study of in-ear devices, which are placed in the ear like earphones, reported that ear sensors showed faster response than finger sensors [25]. Reflective pulse oximeters worn on the forehead have also been reported to respond more quickly than conventional pulse oximeters [29]. The oral cavity, ears, and forehead are closer to the central vascular system and lungs than the fingers.

## 5. Conclusions

In this study, a small, low-power sensor attached to a mouthpiece was used to measure SpO<sub>2</sub> in the oral cavity for the first time. The accuracy of the developed SpO<sub>2</sub> measurement device was verified by comparison with the commercial device. Furthermore, there was no significant difference in the baseline SpO<sub>2</sub> values obtained between the oral cavity and the finger at rest. In the oral cavity, the glass surface of SpO<sub>2</sub> sensors without parylene coating became foggy. Subsequently, measurements were taken at different locations in the oral cavity, revealing that the maxillary canine area was the appropriate site for measuring SpO<sub>2</sub>. The pressure range of 0.3 to 0.8 N was determined to be the most appropriate for practical measurements. Moreover, the SpO<sub>2</sub> values in the oral cavity were reflected approximately 7 s (18%) earlier than those measured on the finger, and changes in SpO<sub>2</sub> values could be detected more acutely.

Although conventional pulse oximeters are simple to use, measurements at the periphery, such as the fingers, are difficult to obtain when blood flow is reduced because of hypothermia or other circulatory conditions [6,30,31]. Hypothermia is a symptom in older patients and those with multiple diseases and is associated with a decrease in pulse rate as the body temperature falls [32,33]. However, this important sign may be inaccurately measured with a conventional finger-worn pulse oximeter [34,35]. Considering that the oral cavity is close to the center of the body, it should be possible to detect changes in blood oxygen saturation in the central region and a decrease in pulse rate due to hypothermia.

Numerous devices are commonly used in the oral cavity, including dentures, aligners, splints, and functional devices for orthodontic treatment. By adding sensing functions to these devices, more accurate biometric information can be obtained, which can also be used for individual health management and home healthcare. Moreover, important signs that have been impossible to measure with the finger may be detectable in the oral cavity. The present study not only demonstrates the potential of the oral cavity as a new site for acquiring biological information but also establishes a new method for accurately measuring SpO<sub>2</sub> in the oral cavity.

**Author Contributions:** Writing—original draft preparation, Y.K.; supervision, K.M.; project administration, Y.Y.; methodology, M.O.; data curation, R.I.; visualization, N.K. All authors have read and agreed to the published version of the manuscript.

**Funding:** This research received no external funding.

**Institutional Review Board Statement:** This study, including the waterproofing test and human safety, was conducted in accordance with the Declaration of Helsinki and approved by the Institutional Review Board of Showa University Dental Hospital (protocol code no. 21-005-A; approved on 23 August 2021).

**Informed Consent Statement:** Informed consent was obtained from all individuals involved in the study and written informed consent was obtained from the volunteers to publish this paper.

**Data Availability Statement:** Data are contained within the article.

**Acknowledgments:** We are grateful to Shigeaki Ohtsuki, from the Japan Institute of Statistical Technology (Tokyo, Japan), for his help with the statistical analysis.

**Conflicts of Interest:** Author Ryosuke Isogai, Noboru Kawai and Yoshifumi Yoshida were employed by the company Seiko Future Creation Inc. The remaining authors declare that the research was conducted in the absence of any commercial or financial relationships that could be construed as a potential conflict of interest.

## References

- Hafen, B.B.; Sharma, S. Oxygen Saturation. In *StatPearls*; StatPearls Publishing LLC: Treasure Island, FL, USA, 2023.
- Koseeyaporn, J.; Wardkein, P.; Sinchai, A.; Kainan, P.; Tuwanut, P. Pulse Oximetry Based on Quadrature Multiplexing of the Amplitude Modulated Photoplethysmographic Signals. *Sensors* **2023**, *23*, 6106. [\[CrossRef\]](#)
- Nitzan, M.; Romem, A.; Koppel, R. Pulse oximetry: Fundamentals and technology update. *Med. Devices* **2014**, *7*, 231–239. [\[CrossRef\]](#)
- Banik, P.P.; Hossain, S.; Kwon, T.-H.; Kim, H.; Kim, K.-D. Development of a wearable reflection-type pulse oximeter system to acquire clean PPG signals and measure pulse rate and SpO<sub>2</sub> with and without finger motion. *Electronics* **2020**, *9*, 1905. [\[CrossRef\]](#)
- Chan, E.D.; Chan, M.M.; Chan, M.M. Pulse oximetry: Understanding its basic principles facilitates appreciation of its limitations. *Respir. Med.* **2013**, *107*, 789–799. [\[CrossRef\]](#)
- MacLeod, D.B.; Cortinez, L.I.; Keifer, J.C.; Cameron, D.; Wright, D.R.; White, W.D.; Moretti, E.W.; Radulescu, L.R.; Somma, J. The desaturation response time of finger pulse oximeters during mild hypothermia. *Anaesthesia* **2005**, *60*, 65–71. [\[CrossRef\]](#)
- Budidha, K.; Kyriacou, P.A. In vivo investigation of ear canal pulse oximetry during hypothermia. *J. Clin. Monit. Comput.* **2018**, *32*, 97–107. [\[CrossRef\]](#)
- Masè, M.; Micarelli, A.; Strapazzon, G. Hearables: New Perspectives and Pitfalls of In-Ear Devices for Physiological Monitoring. A Scoping Review. *Front. Physiol.* **2020**, *11*, 568886. [\[CrossRef\]](#)
- Pal, S.K.; Kyriacou, P.A.; Kumaran, S.; Fadheel, S.; Emamdee, R.; Langford, R.M.; Jones, D.P. Evaluation of oesophageal reflectance pulse oximetry in major burns patients. *Burns* **2005**, *31*, 337–341. [\[CrossRef\]](#)
- Reisner, A.; Shaltis, P.A.; McCombie, D.; Asada, H.H. Utility of the photoplethysmogram in circulatory monitoring. *Anesthesiology* **2008**, *108*, 950–958. [\[CrossRef\]](#)
- Tamura, T. Current progress of photoplethysmography and SPO<sub>2</sub> for health monitoring. *Biomed. Eng. Lett.* **2019**, *9*, 21–36. [\[CrossRef\]](#)
- Torp, K.D.; Modi, P.; Simon, L.V. Pulse Oximetry. In *StatPearls*; StatPearls Publishing LLC: Treasure Island, FL, USA, 2023.
- Budidha, K.; Kyriacou, P.A. The human ear canal: Investigation of its suitability for monitoring photoplethysmographs and arterial oxygen saturation. *Physiol. Meas.* **2014**, *35*, 111–128. [\[CrossRef\]](#)
- Hickey, M.; Samuels, N.; Randive, N.; Langford, R.M.; Kyriacou, P.A. An in vivo investigation of photoplethysmographic signals and preliminary pulse oximetry estimation from the bowel using a new fiberoptic sensor. *Anesth. Analg.* **2011**, *112*, 1104–1109. [\[CrossRef\]](#)
- Kyriacou, P.A.; Jones, D.P.; Langford, R.M.; Petros, A.J. A pilot study of neonatal and pediatric esophageal pulse oximetry. *Anesth. Analg.* **2008**, *107*, 905–908. [\[CrossRef\]](#)
- Lee, E.J.; Kim, Y.; Salipante, P.; Kotula, A.P.; Lipshutz, S.; Graves, D.T.; Alimperti, S. Mechanical Regulation of Oral Epithelial Barrier Function. *Bioengineering* **2023**, *10*, 517. [\[CrossRef\]](#)
- Waasdorp, M.; Krom, B.P.; Bikker, F.J.; van Zuijlen, P.P.M.; Niessen, F.B.; Gibbs, S. The Bigger Picture: Why Oral Mucosa Heals Better Than Skin. *Biomolecules* **2021**, *11*, 1165. [\[CrossRef\]](#)
- Hamdoon, S.M.; AlSamak, S.; Ahmed, M.K.; Gasgoos, S. Evaluation of biofilm formation on different clear orthodontic retainer materials. *J. Orthod. Sci.* **2022**, *11*, 34.
- Shiotsu, R.; Yoshida, Y.; Haga, S.; Maki, K. Development of a new intraoral sensing system for measuring the wearing time of clear aligner. *Jpn. J. Digit. Dent.* **2022**, *11*, 118–126.

20. Morikawa, K.; Isogai, R.; Nonaka, J.; Yoshida, Y.; Haga, S.; Maki, K. A New Intraoral Six-Degrees-of-Freedom Jaw Movement Tracking Method Using Magnetic Fingerprints. *Sensors* **2022**, *22*, 8923. [[CrossRef](#)]
21. Corsini, I.; Cecchi, A.; Coviello, C.; Dani, C. Perfusion index and left ventricular output correlation in healthy term infants. *Eur. J. Pediatr.* **2017**, *176*, 1013–1018. [[CrossRef](#)]
22. Tulay, C.M.; Gurmen, E.S. Dyspnea: Perfusion index and triage status. *J. Clin. Monit. Comput.* **2023**, *37*, 1103–1108. [[CrossRef](#)]
23. Altman, D.G.; Bland, J.M. Measurement in medicine: The analysis of method comparison studies. *J. R. Stat. Soc. Ser. D Stat.* **1983**, *32*, 307–317. [[CrossRef](#)]
24. Giavarina, D. Understanding Bland Altman analysis. *Biochem. Med.* **2015**, *25*, 141–151. [[CrossRef](#)]
25. Davies, H.J.; Williams, I.; Peters, N.S.; Mandic, D.P. In-Ear Measurement of Blood Oxygen Saturation: An Ambulatory Tool Needed To Detect The Delayed Life-Threatening Hypoxaemia in COVID-19. *arXiv* **2020**, arXiv:2006.04231.
26. Ueno, D.; Sekiguchi, R.; Morita, M.; Jayawardena, A.; Shinpo, S.; Sato, J.; Kobayashi, K. Palatal mucosal measurements in a Japanese population using cone-beam computed tomography. *J. Esthet. Restor. Dent.* **2014**, *26*, 48–58. [[CrossRef](#)]
27. Sampietro-Martínez, R.; Pérez-Monreal, J.; Sánchez-Torres, A.; Bara-Casaus, J.; Gay-Escoda, C. Color doppler ultrasound for the assessment of palatal fibromucosa thickness and the trajectory of the greater palatine artery: A pilot study. *J. Clin. Exp. Dent.* **2022**, *14*, e528–e533. [[CrossRef](#)]
28. Teng, X.; Zhang, Y.-T. The effect of contacting force on photoplethysmographic signals. *Physiol. Meas.* **2004**, *25*, 1323. [[CrossRef](#)]
29. Choi, S.J.; Ahn, H.J.; Yang, M.K.; Kim, C.S.; Sim, W.S.; Kim, J.A.; Kang, J.G.; Kim, J.K.; Kang, J.Y. Comparison of desaturation and resaturation response times between transmission and reflectance pulse oximeters. *Acta Anaesthesiol. Scand.* **2010**, *54*, 212–217. [[CrossRef](#)]
30. McCullough, L.; Arora, S. Diagnosis and treatment of hypothermia. *Am. Fam. Physician* **2004**, *70*, 2325–2332.
31. Van Veelen, M.J.; Brodmann Maeder, M. Hypothermia in Trauma. *Int. J. Environ. Res. Public Health* **2021**, *18*, 8719. [[CrossRef](#)]
32. Rauch, S.; Miller, C.; Bräuer, A.; Wallner, B.; Bock, M.; Paal, P. Perioperative Hypothermia—A Narrative Review. *Int. J. Environ. Res. Public Health* **2021**, *18*, 8749. [[CrossRef](#)]
33. Paal, P.; Pasquier, M.; Darocha, T.; Lechner, R.; Kosinski, S.; Wallner, B.; Zafren, K.; Brugger, H. Accidental Hypothermia: 2021 Update. *Int. J. Environ. Res. Public Health* **2022**, *19*, 501. [[CrossRef](#)]
34. Kelly, K.L.; Carlson, A.R.; Allison, T.G.; Johnson, B.D. A comparison of finger and forehead pulse oximeters in heart failure patients during maximal exercise. *Heart Lung* **2020**, *49*, 259–264. [[CrossRef](#)]
35. Wick, K.D.; Matthay, M.A.; Ware, L.B. Pulse oximetry for the diagnosis and management of acute respiratory distress syndrome. *Lancet Respir. Med.* **2022**, *10*, 1086–1098. [[CrossRef](#)]

**Disclaimer/Publisher’s Note:** The statements, opinions and data contained in all publications are solely those of the individual author(s) and contributor(s) and not of MDPI and/or the editor(s). MDPI and/or the editor(s) disclaim responsibility for any injury to people or property resulting from any ideas, methods, instructions or products referred to in the content.