

## Article

# An AI-Layered with Multi-Agent Systems Architecture for Prognostics Health Management of Smart Transformers: A Novel Approach for Smart Grid-Ready Energy Management Systems

Oussama Laayati <sup>1,2,\*</sup> , Hicham El Hadraoui <sup>2</sup> , Adila El Magharaoui <sup>2</sup> , Nabil El-Bazi <sup>2</sup>, Mostafa Bouzi <sup>1</sup>, Ahmed Chebak <sup>2</sup> and Josep M. Guerrero <sup>3</sup> 

<sup>1</sup> Computer Science, Mechanical, Electronics and Telecommunication Laboratory (LMIET), Faculty of Sciences and Techniques (FST), Hassan First University of Settat (UH1), Settat 26000, Morocco

<sup>2</sup> Green Tech Institute (GTI), Mohammed VI Polytechnic University (UM6P), Benguerir 43150, Morocco

<sup>3</sup> Center for Research on Microgrids (CROM), AAU Energy, Aalborg University, 9220 Aalborg, Denmark

\* Correspondence: oussama.laayati@gmail.com; Tel.: +212-666-343-097

**Abstract:** After the massive integration of distributed energy resources, energy storage systems and the charging stations of electric vehicles, it has become very difficult to implement an efficient grid energy management system regarding the unmanageable behavior of the power flow within the grid, which can cause many critical problems in different grid stages, typically in the substations, such as failures, blackouts, and power transformer explosions. However, the current digital transition toward Energy 4.0 in Smart Grids allows the integration of smart solutions to substations by integrating smart sensors and implementing new control and monitoring techniques. This paper is proposing a hybrid artificial intelligence multilayer for power transformers, integrating different diagnostic algorithms, Health Index, and life-loss estimation approaches. After gathering different datasets, this paper presents an exhaustive algorithm comparative study to select the best fit models. This developed architecture for prognostic (PHM) health management is a hybrid interaction between evolutionary support vector machine, random forest, k-nearest neighbor, and linear regression-based models connected to an online monitoring system of the power transformer; these interactions are calculating the important key performance indicators which are related to alarms and a smart energy management system that gives decisions on the load management, the power factor control, and the maintenance schedule planning.

**Keywords:** smart grid; power transformer; energy management; PHM; multi-agent; machine learning



**Citation:** Laayati, O.; El Hadraoui, H.; El Magharaoui, A.; El-Bazi, N.; Bouzi, M.; Chebak, A.; Guerrero, J.M. An AI-Layered with Multi-Agent Systems Architecture for Prognostics Health Management of Smart Transformers: A Novel Approach for Smart Grid-Ready Energy Management Systems. *Energies* **2022**, *15*, 7217. <https://doi.org/10.3390/en15197217>

Academic Editor: Zbigniew Nadolny

Received: 22 August 2022

Accepted: 23 September 2022

Published: 1 October 2022

**Publisher's Note:** MDPI stays neutral with regard to jurisdictional claims in published maps and institutional affiliations.



**Copyright:** © 2022 by the authors. Licensee MDPI, Basel, Switzerland. This article is an open access article distributed under the terms and conditions of the Creative Commons Attribution (CC BY) license (<https://creativecommons.org/licenses/by/4.0/>).

## 1. Introduction

In the current energy transition toward smart grids, increasing the amount of renewable energies integration, photovoltaic, wind power, concentrated solar power, new energy storage systems, and new loads such as electric vehicles which are impacting the energy demand response [1] and load profile of either production [2] or consumption [3]. These changes are making the electrical grid unstable due to the variation of the power flows maintained by power transformers which are representing the most critical component in the grid where its failures impact directly the grid and cause instability, blackouts, and deadly incidents with high cost (knowing that a power transformer can cost from USD 600,000.00 to more than USD 4,000,000.00 depending on the power, respectively, from 10 MVA to 100 MVA). Therefore, it is mandatory to think about new ways to protect this equipment to protect the grid, integrating several technologies and techniques which are answering the challenges faced by the grid and the power transformers. The main challenge is maintaining the functionalities and the reliability of the power transformer by a hybrid monitoring technique focusing on different components and subsystems.

This hybrid online system diagnoses the power transformer by giving an overall Health Index score with details on the current failures and state of each component. Based on this proposed system, the results are directly communicated with a distributed smart energy management system that gives real time decision-making to improve the quality of the power flow in the grid and proposing an optimized preventive maintenance scheduling plan. The Health Index calculation incorporates the insulation paper Health Index based on top oil temperature, load, ambient temperature, and water temperature; for oil quality diagnosis, the interfacial tension, moisture, and breakdown voltage determine its Health Index based on IEC 60422. According to IEEE C57-104-2008, the dissolved gas analysis Health Index is calculated by monitoring its particles per million for hydrogen, methane, ethylene, acetylene, ethanol, and other gases. Daniella has proposed a Health Index calculation [4] which was validated by 204 power transformer datasets and can also calculate the life loss of the power transformer in real time, the estimation of the Health Index can be done using Markov chain by retrieving data of the oil monitoring technique, and then calculating the Health Index; Determining the average and rearranging it by zone or age, the transition probabilities can be computed, as Muhammad employed this strategy [5] and confirmed by 3195 datasets obtained from oil samples analyzed from power transformers aged 1 to 25 years (373 total). The Health Index calculation can be enhanced by introducing multi-criteria analysis for example fuzzy analytic hierarchy process or fuzzy technique for order preference by similarities to ideal solution [6,7].

In recent work, Daniella presented an enhanced diagnostic methodology Health Index estimation based on data of 204 power transformers and their maintenance history as a tool that can be used for maintenance scheduling and planning integrating dissolved gas analysis (DGA), oil quality factor (OQF), and load history (LH) [4]; however, this methodology can be enhanced and improved using more diagnostic factors such as the global loss factor (GLF), the infrared thermography, the Furans content, and other subcomponent indicators, as described by Bogdan in their proposition of calculating the different Health Indexes of the power transformers [8]; these propositions are very efficient offline methodologies which can be used by power transformer maintenance managers and can be integrated in an online monitoring platform or system.

Jorn proposed a methodology to calculate the Health Index, the risk and estimating the lifetime of the power transformer by combining three models based on winding degradation, expert judgement, and the statistics of the life cycle of the power transformer [9]. The Health Index calculation has been proposed by Naderian by applying the multi-criteria approach and combining different monitoring and diagnostic techniques [10]. This article proposes an online Health Index and lifetime estimation approach based on dissolved gas analysis (DGA), water content in the oil, dibenzyl disulfide (DBDS), and electrical measurements such as dielectric rigidity, power factor, and interfacial voltage.

The role of a power transformer in a smart grid is critical, and its failures are impacting all grid components multidimensionally, causing blackouts, voltage instability, harmonics and sometimes explosions if the maintenance scheduling is not well managed. Therefore, many researchers have developed new architectures for smart power transformers integrating different monitoring techniques such as thermal image processing, dissolved gas analysis, oil preservation, vibration analysis and others in order to look for correlations between these techniques; these monitoring techniques are connected to a smart energy management system that gives decisions in different grid components [11,12]. Figure 1 shows the main components of the power transformer architecture. For self-diagnostics and reliability, which are connected to prognostic and health management proposed in [11,13], the goal is making the power transformer detect failure and act with the help of a smart energy management system which is connected to load management and energy demand and peak load prediction proposed in [14,15].

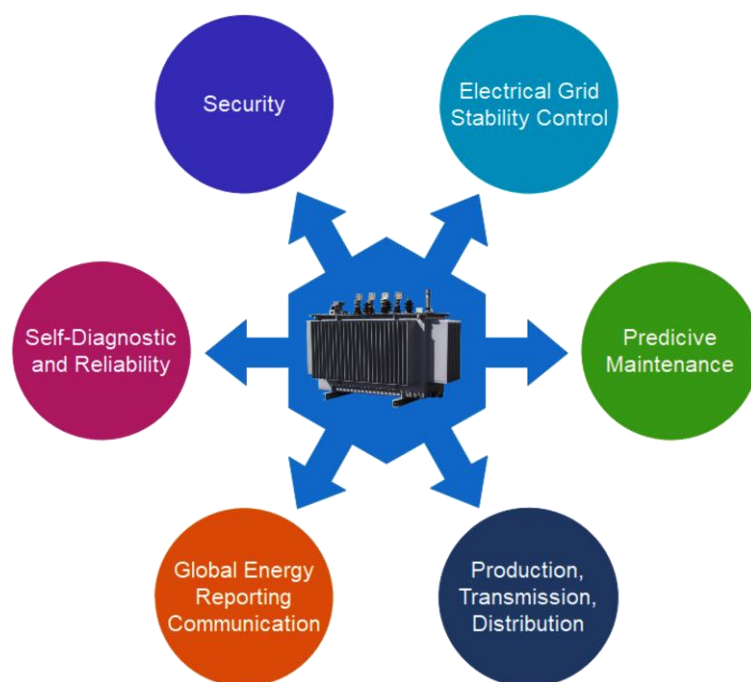

**Figure 1.** Smart power transformer features.

The power transformer is responsible for electrical grid stability in different power flow levels of production, transmission, and distribution while reporting and communicate all necessary data for the energy management system, such as electrical data from power meters, dissolved gas analysis from different gas sensors, and the temperature of different components.

However, the security feature is very vulnerable to attack and to false data injection due to the very well-known communication protocols of sensors and the data gateway installed within the transformer; therefore, it is mandatory to use a blockchain approach for the communication of the power meters and all installed kits in the transformer, and this concept was developed in recent work in [16–18], where proposing a new communication architecture for power meters to prevent the false data injection and activate the energy market, the same approach is proposed for the communication protocols in the different sensor kits and gateways installed in the power transformer. All acquired data from different sensors installed directly impact the developed models of diagnostics, prediction, and life loss estimation; therefore, false information from a kit or a bad communication is a false input to the models which deliver a bad decision on load management or power factor adjustment, making it mandatory to develop a false data injection detection [19] in the proposed architecture in future work.

This paper is proposing a new approach toward smart power transformer following the energy digital transition, integrating online monitoring systems, machine learning models, and data management applications. Figure 2 shows the paper structure and the research methodology, starting with listing the power transformer failures, causes and effects analysis, and following the ISHIKAWA approach by then listing the Health Index and life-loss estimation methods. In the second part of the paper, an exhaustive list of monitoring techniques for each failure is proposed to enhance the hybrid architecture enabling the prognostic health management, followed by a comparative study of other developed algorithms from different researchers using machine learning.

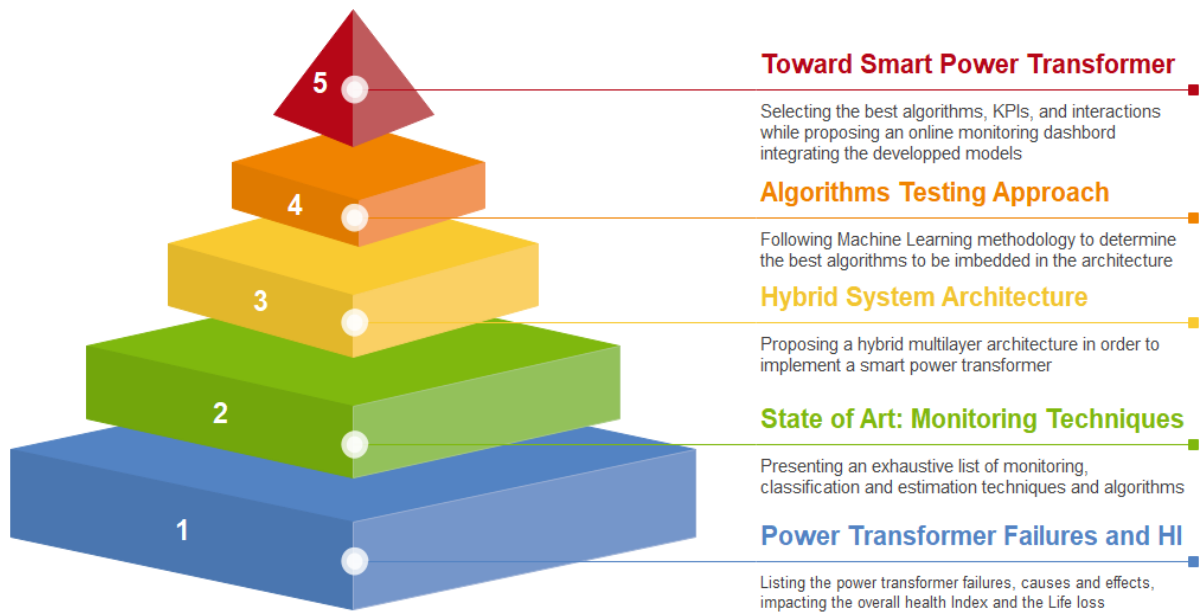

Figure 2. Paper structure.

After these two steps, the paper proposes a hybrid system architecture where different hardware, software, and human agents are interacting in different connected layers to make the power transformer smart, and autonomously connected with an energy management system. Therefore, it is mandatory to test different machine learning algorithms for defect classification, life loss, and Health Index estimation in order to select the best fit algorithms and be embedded in the proposed architecture; this step was developed using RapidMiner software based on dissolved gas analysis datasets [20,21] and the Health Index, and the life-loss estimation dataset in [22]. After selecting the best fit models, the paper presents a database, model, KPI, and monitoring interface interactions using Thingsboard platform.

**2. Power Transformer Failures**

Figure 3 depicts the many forms of failure as defined by the IEEE standard for evaluating and reconditioning liquid immersed power transformers [23]. Specifically, bushing failures, oil preservation system failures, radiator failures, core failures, winding assembly failures caused by turn, coil, or ground faults, and lead connection or insulation break-downs are the most common. The purpose of this study is to identify the flaws of various power transformer failures [24]. Therefore, it is mandatory to list each failure cause and effect through inspection in the various components of the immersed oil power transformer shown in Figure 4 and integrate it into a smart energy management system [25].

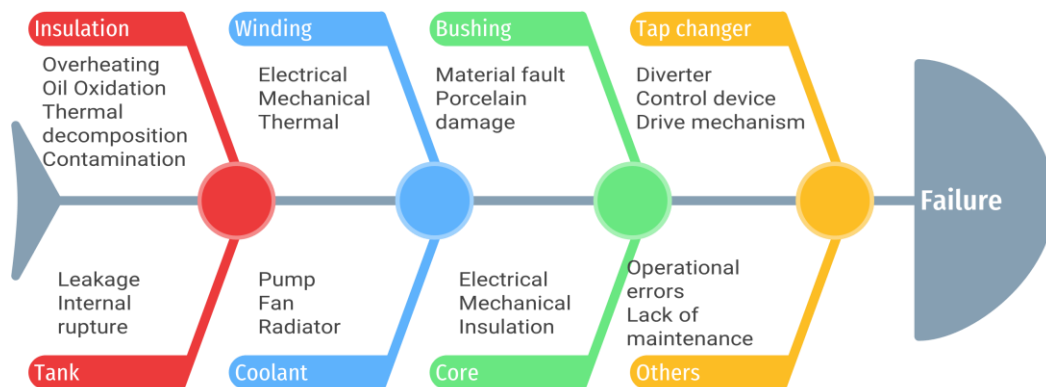

Figure 3. ISHIKAWA diagram of power transformer failures.

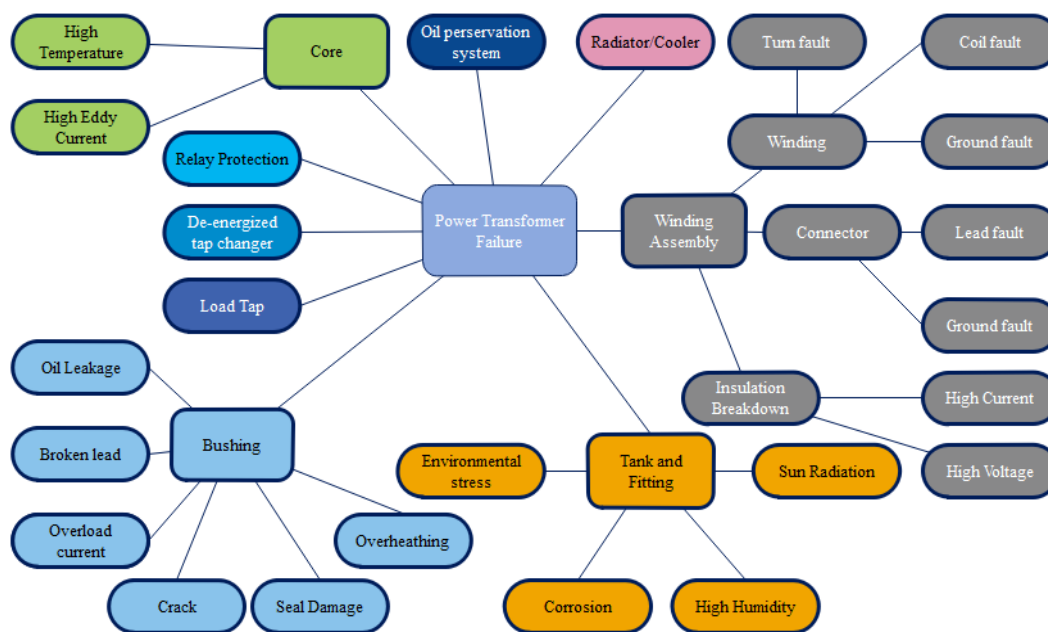

Figure 4. Types of failures inspections in the different components.

Figure 4 describes the inspections of different failures appearing in all power transformer components [26] in order to design an intelligent system and automate the failure categorization process through the use of sensors, data collecting, data preprocessing, and machine learning as a self-diagnostic and decision-making assistance; displaying the cause effect analysis also helps to better understand the causes and identify the best maintenance planning option to follow the online self-diagnostic system findings.

### 3. Power Transformer Monitoring Techniques

Many strategies are effective for classifying the various sorts of failures stated, as seen in Figure 5 and established by Lekshmi in the study of monitoring techniques [27]; for example, for thermal analysis, which needs a thermal camera and a data acquisition device to record the power transformer’s image data, deep learning algorithms are used to categorize failures, primarily internal winding problems.

The power transformer’s vibration route is caused by winding and core vibration, which affects the mechanical joints and the cooling oil applied to the tank surface [28]. The accelerometers, which are positioned on the windings and the tank, give data to a diagnosis system, which classifies the failures as generally core problems. The detection of winding movement, which aids in the diagnosis of inter-winding faults, the dissolved gas analysis, and the partial discharge analysis which classifies by monitoring the number of particles per million of oil in order to predict the oil quality and Health Index in the tank, are all internal failures. External failures, on the other hand, such as load fault tap changers, may be found using frequency analysis by wavelet transformer, which commonly uses the fast Fourier transform and wavelets to find insulation defects and on-load tap changer monitoring and other computational techniques using support vector machines [29].

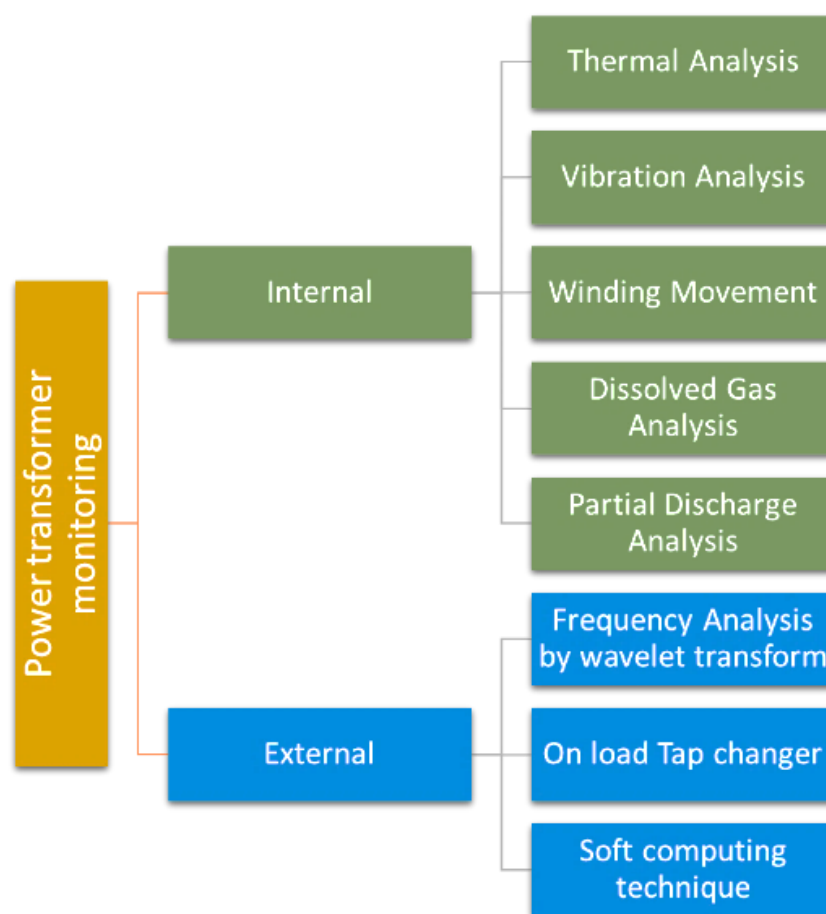

**Figure 5.** Power transformer monitoring techniques.

### 3.1. Temperature-Overheating

Local overheating at temperatures lower than 300 °C (also known as low-temperature overheating) is a common flaw in high-voltage power transformers. The appearance of such flaws does not result in immediate transformer damage, but it does accelerate the aging processes of the insulation and shortens its service life [30]. This paper addresses five labels or inspections of the overheating of the power transformer: the true false, thermal fault label, basically describing only if there is an existence of thermal fault or not, and in the second dataset, there are four levels of overheating (high, middle, middle-low and low temperature overheating, giving more exact levels of temperatures).

### 3.2. Discharges

IEC 60270 defines discharges as localized dielectric discharges in a partial portion of a solid or liquid electrical dielectric insulation system under high-voltage field stress. Partial discharges in a transformer damage its insulation and can cause the transformer to fail. Transient surges can cause transformer failure. To maintain good insulation coordination in such failures, the transformer insulation withstand should be evaluated using arrester discharge voltage. Electrical failure mechanisms include lightning, over-excitation, switching surges, winding resonance, turn-to-turn short circuits, layer-to-layer short circuits, partial discharges, insulation tracking, static electrification of oil, and flashovers [31]. This paper proposes a two classification approach, with the first one classifying three types of discharges (spark, partial and arc discharge based on five gas datasets) and the second approach classifying two levels of discharge (high intensity and low intensity based on six gas datasets). Both datasets are the result of dissolved gas analysis and expert comments.

#### 4. State-of-the-Art Machine Learning-Based Methodologies for Power Transformers

The use of machine learning algorithms has become mandatory to develop diagnostic and prognostic models, predicting the critical failures in the power transformer while estimating the overall Health Index and the lifetime loss or the aging. Therefore, many researchers are exploiting the discussed monitoring techniques in the previous section, for example, the dissolved gas analysis, to classify internal faults and calculate the general health of the power transformer using time series, extreme learning machines, linear programming boosting, relevance support vector machines, and other algorithms. Others are using acoustic signals, oil quality, degree of polymerization, and thermal image processing to predict abnormality within different components of the power transformer or estimating life loss. Table 1 represents exhaustive, state-of-the-art machine learning-based methodologies for power transformer diagnostics, mentioning more than 37 researchers who have practically performed a comparative study of these algorithms in different goals with high accuracies. This state-of-the-art study has helped to select the main algorithms that can be introduced in the proposed hybrid artificial intelligence architecture for the prognostic health management of the power transformer.

**Table 1.** State-of-the-art machine learning-based methodologies for power transformer diagnostics.

Team	Date	Goal	Methodology	Algorithm	Accuracy
Hao [32]	2021	General Health	Temperature and Dissolved Gas Analysis	Timeseries	98%
Maulik [33]	2020	Internal fault	Discrete wavelets transform	Hierarchical Ensemble Extreme Learning Machine	99.91%
Xiaoxing [34]	2021	General Diagnosis	Dissolved Gas Analysis	Improved Firefly Algorithm Linear Programming Boosting	95.172%
Lijing [35]	2021	Insulation Condition Assessment	Dissolved Gas Analysis	Deep Belief Network	91.59%
Zahra [36]	2021	Internal faults	Faults history	Extended Kalman Filter-Support vector Machine	98.42%
Rengaraj [37]	2020	State Determination	Insulation condition	Analytical Hierarchy Process-Technique for Order Preference by Similarity to ideal Solution	90%
Dharmesh [38]	2018	Magnetising Inrush, CT saturation and high resistance internal fault	Simulation PSCAD/EMTDCT	Relevance Vector Machine	99.97%
Giovanni [39]	2022	Insulation Dielectric Response Model	Modelling	Frequency domain spectroscopy	99%
Mintai [40]	2021	Voltages classification	Acoustic signal acquisition	Convolutional Neural Network	94%
George [41]	2021	Incipient Fault Detection	Multinomial Dissolved Gas Analysis	KosaNet (Based on Decision Trees)	95%
Mohammed [42]	2021	Oil Quality assessment	Oil Quality dataset	J48 Decision tree and Random Forest	83%
Sherif [43]	2021	Insulating paper state	Degree of polymerization	Decision Tree	96.2%
Chin-Tan [44]	2020	Cast-resin Abnormality detection	Failure History	Fuzzy Logic Clustering Decision Tree	87.75%
Jingxin [45]	2016	Ageing Stage Assessment of oil paper insulation	Raman Spectral characteristics	Principal Component Analysis-Support Vector machine	99.73%
Oussama [46]	2022	Failures Classification	Dissolved Gas Analysis	Artificial Neural Network Bootstrap-Genetic	94.76%
Almas [47]	2008	Fault Classification	Dissolved Gas Analysis	Algorithm-Support Vector Machine	92.11%
Xiong [48]	2007	Fault Diagnosis	Dissolved Gas Analysis	Artificial Immune Network	93.2%

Table 1. Cont.

Team	Date	Goal	Methodology	Algorithm	Accuracy
Mengda [49]	2021	Fault prediction	Dissolved Gas Chromatography	Mish-SN Temporal Convolutional Network	99%
Ali [50]	2021	Fault classification	Dissolved Gas Analysis	C-Set Fuzzy C-Means	88.9%
Alireza [51]	2021	Winding deformation classification	Time-Frequency Response Analysis	Hilbert-Huang transform-evidence theory	80%
Tadeja [52]	2002	Fault Classification	Protection signal	Bayes theory-Norms Generating	76.4%
Sudha [53]	2022	Fault Classification	Short circuit resistance testing	K-Nearest Neighbour	62%
Ricardo [54]	2021	Oil and Kraft Degradation	Dissolved Gas Analysis	Support Vector Machine	97.55%
Jian [55]	2021	Discharge and overheating faults	Infrared Image Processing	Generative Adversarial Network	86.2%
Rucconi [56]	2021	Deformation, Shift, Loss of clamping pressure	Vibration Data	Artificial Neural network	91.63%
Sofia [57]	2021	Incipient fault diagnosis	Dissolved Gas Analysis	Synthetic minority oversampling technique	85%
Bing Zeng [58]	2019	Health Index	Dissolved Gas Analysis	Deep learning Least Square Support Vector Machine	98.9%
Rahman [59]	2020	Faults severity	Dissolved Gas Analysis	Support vector machine-based Duval Pentagon Method	97%
Wei zhang [60]	2020	Power transformer health	Dissolved Gas Analysis	Neural Network Whale Optimization	91%
Ali kirkbas [61]	2020	Health index	Dissolved Gas Analysis	Support Vector Machine Particle Swarm Optimizer	94.67%
Hasmat malik [62]	2020	Energy discharge, Partial discharge	Dissolved Gas Analysis	Fuzzy Reinforcement learning	99.7%
Ricardo [63]	2020	Health Index	Dissolved Gas Analysis	Artificial Neural Network	84.45%
Yousuf [64]	2021	Aging, sparking, Overheating	Dissolved Gas Analysis	Logistic Regression	85.6%
Aciu [65]	2021	Overheating	Dissolved Gas Analysis	Artificial Neural Network	93.5%
Nitchamon [66]	2021	Failure Index	Dissolved Gas Analysis	Fuzzy logic	75.73%
Zhanhong [67]	2021	Partial Discharge	Dissolved Gas Analysis	Improved Genetic algorithm and XGBoost	99.2%
Weiyun [68]	2021	Multiple Fault Diagnosis	Dissolved Gas Analysis	Semi supervised Transfer learning	95%
Yichen [69]	2021	Health Index	Dissolved Gas Analysis	Artificial Neural Network	99.71%

## 5. Hybrid Artificial Intelligence System Architecture

After developing different algorithms used in power transformer diagnostics using multiple inputs and inspection methodologies, it is shown that there are some monitoring techniques which are online-based on automated data collection from sensors installed in the transformer, while other monitoring techniques are offline-based on laboratory testing on samples or offline inspections by maintenance agents.

The goal of this architecture is to provide a smart system that diagnoses the power transformer and communicates with a decision system that manages loads, adjusts the power factor, and gives a maintenance plan to maximize the lifetime of the power transformer, enabling prognostic health management. This system is connected to a platform visualizing all measurements and key performance indicators combining different interactions between each layer and agent, as presented in Figure 6.



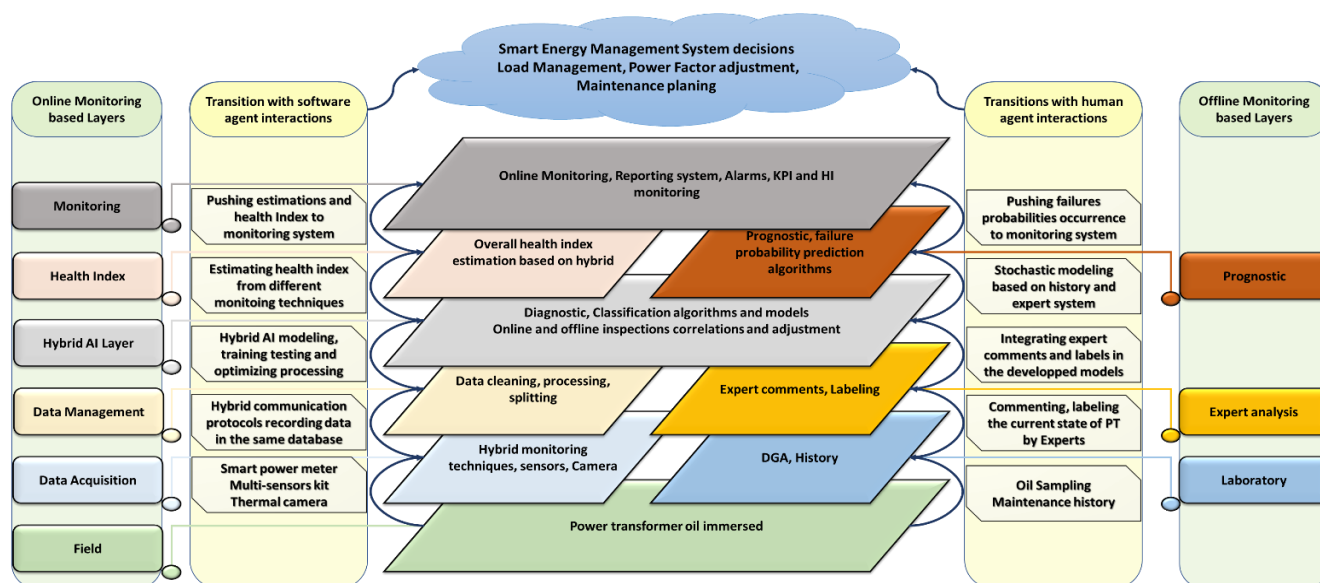

Figure 6. Hybrid AI multilayers architecture for prognostic health management.

### 5.1. Online Monitoring Based Layers

As described in the monitoring techniques presentation in the previous sections, the architecture is composed by multiple layers, the online monitoring-based layers which are encircling the sensors installed in the power transformer, the data acquisition, management, hybrid artificial intelligence models Health Index calculation, and the KPI monitoring; these layers are connected to the smart energy management system for processing and decision-making, and this approach can be used to develop a digital twin for the power transformer [70,71].

#### 5.1.1. Field

In the field layer, a set of sensors and kits are installed, typically power meters, thermal cameras, vibration sensors, for measuring temperature in all power transformer components. Mainly the dissolved gas analysis kit which is measuring the particles per million of the different gases in the oil. These sensors are treated and pre-processed using the sensor fusion methodology.

#### 5.1.2. Data Acquisition

The field layer is connected to the data acquisition layer, where all sensors are communicating with servers through gateways and communication protocols. In order to optimize the solution, it is mandatory to unify the communication protocol of the different sensors for example using Modbus TCP/IP protocol for the power meter, the gas sensor gateway, and the camera; this way it is very easy for the maintenance agent to manage communication problem and to find the change parts because all gateways are connected in the same protocol.

#### 5.1.3. Data Management

After acquiring the data and communicated to the database, there is a set of programs to clean, process, and split the data in order to supply the different developed models. This layer is connected parallelly to the expert comments and labeling layer by experts, and that way all data will be labeled and have meaning in order to be exploitable to classify the data by the hybrid artificial intelligence layer.

#### 5.1.4. Hybrid Artificial Intelligence

The hybrid artificial intelligence layer integrates all acquired data in the field, data acquisition data management, laboratory, and expert analysis layers. This layer is exploiting these data to classify the failures inspected by the experts and look for correlations between the data collected from sensors, laboratory, and expert inspections, thereby optimizing the models afterward.

#### 5.1.5. Health Index

Based on the output of the previous hybrid layer, the system is calculating or estimating the overall Health Index of the power transformer, taking into consideration the failures, the maintenance history, and the quality of oil, power factors, and all necessary inputs.

This layer is parallelly connected to prognostic layer in order to find a way to estimate the life loss or the lifetime of the power transformer, which is easy to implement; however, estimating or predicting a future failure in the power transformer stays very complicated and theoretically unpredictable, so this architecture will enable a real-time data recording system from both sensors and human providing a big data to analyze, looking for correlation and to re-study the feasibility to predict a future failures in a power transformer and enable the prognostic Health Index.

#### 5.1.6. Monitoring

All layers are directly connected to the monitoring layer, which consists of developing an interface using supervisory, control, and data acquisition (SCADA) software such as CitectScada, WinCC, Factorytalk, or other Internet of Things (IoT) platforms such as NodeRed, Graffana, and Thingsboard. This developed interface allows users to monitor brute data directly from sensors, calculate alarms and results from developed models and as an input for experts to label the data and inspections. In this paper, a proof-of-concept interface of Thingsboard is proposed to better describe the functionalities of the hybrid architecture.

### 5.2. Offline Monitoring Based Layers

As discussed in the previous section, the online monitoring layers are related to the offline-based layers through the interactions of human agents to complete the data statements and give labels to these acquired data and analysis.

#### 5.2.1. Laboratory

In the laboratory layer, the human agent is analyzing the oil samples from the tank of the power transformer, based on dissolved gas analysis, and communicating the daily maintenance history with the smart system by adding the reports to the database to be preprocessed in higher layers looking for correlations and correcting the data in case of a false data communication.

#### 5.2.2. Expert Analysis

In this layer, an expert human agent is interacting with the system by labeling the data and inspecting the health of the power transformer. The expert analysis is the most mandatory layer in the architecture because all decisions, results, models, learning, and correlations are highly impacted by the expert because the ultimate goal of this architecture is providing a big dataset integrating different monitoring techniques and expert analysis to make the power transformer autonomous and make decisions directly with the smart energy management system.

#### 5.2.3. Prognostic

This layer, as discussed before, integrates expert speculations about the future failures which are theoretically unpredictable; however, based on the human interactions, experi-

ences, and more data scenarios, it could be possible to develop new prognostic models for power transformers only if a big dataset is smartly managed.

### 5.2.4. Smart Energy Management System Decisions

All previously discussed layers are connected to the smart energy management system to make decisions in the grid in order to maximize the lifetime of the power transformer by controlling the load connected in the grid, adjusting the power factor and proposing maintenance scheduling of the power transformer. This smart energy management system is connected to other power transformers in the grid, making the learning and the decisions distributed, and the system is also predicting the load and the power flow behavior within the grid using different algorithms developed in recent papers in different applications, for example, in the mining industry [14,15] and hotel building [72] and also predicting the defects of loads, for example, squirrel cage induction motors [25]. Therefore, the smart energy management system is a distributed system connected to different smart grid components [69].

## 6. Methodology

The main objective of this section is to find the best machine learning algorithms, to classify the featured failures discussed in the previous section and to estimate the life loss and the overall Health Index of the power transformer. Therefore, two main objectives have been identified, classification and regression problems. So, using the RapidMiner Studio software, a set of different well-known algorithms discussed in the state-of-the-art section have been tested.

### 6.1. Classification Approach (RapidMiner Approach)

The goal is to test different algorithms, mainly k-nearest neighbor, decision tree, random forest, decision stump, support vector machine (SVM) optimized using particle swarm optimizer (PSO) as well as evolutionarily modifying the kernels, mainly, of radial, multiquadric, epachnenikov, and anova. To find the optimal parameters of the model, the grid optimizer was mandatory. Figure 7 shows the schematic used to find the best fit model to classify the featured failures.

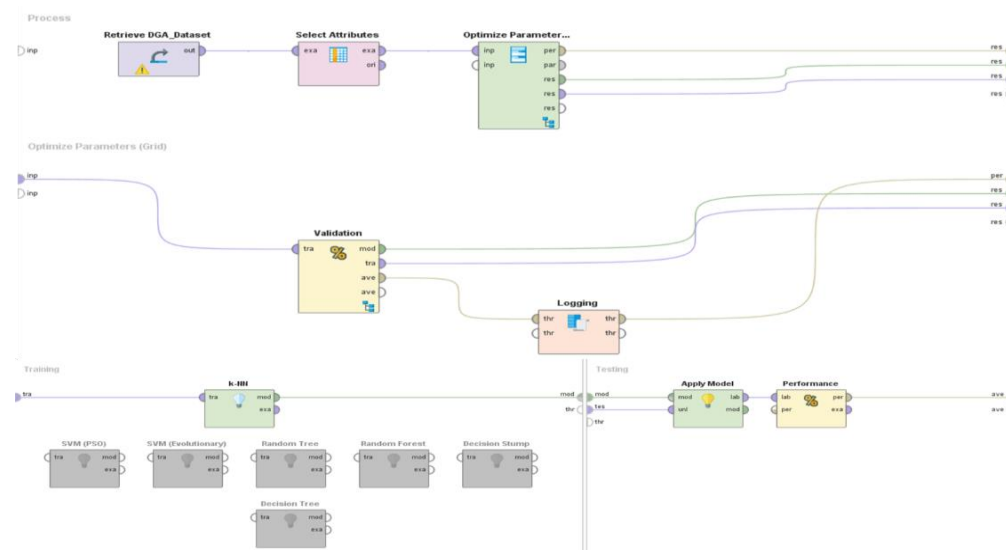
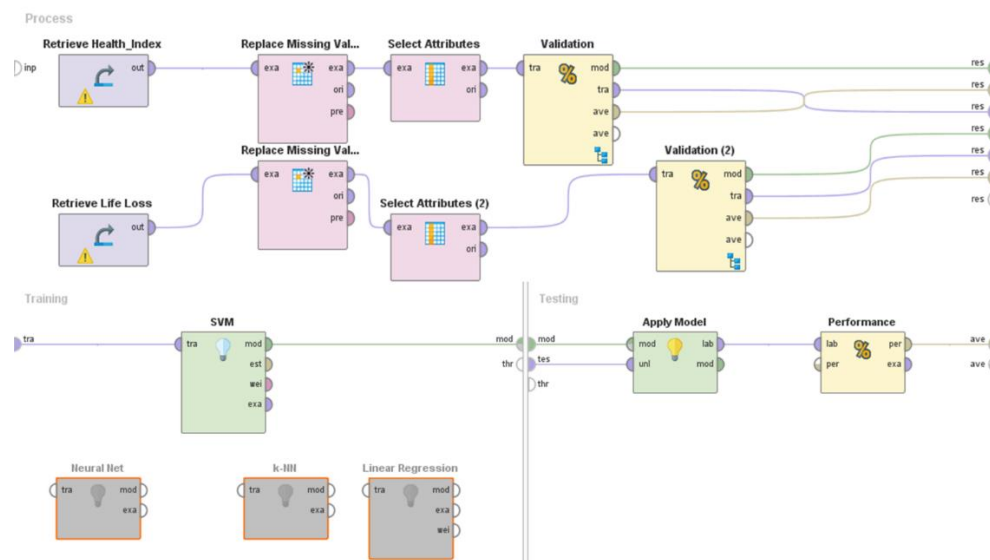

Figure 7. Classification comparative on RapidMiner.

### 6.2. Life Loss and Health Index Estimation Approach (RapidMiner Approach)

After identifying testing, the classification models to classify the discussed failures in the power transformer, the goal is to estimate the overall Health Index and the life loss or the aging; therefore, using the same approach on Rapid Miner, a set of models have

been tested on this regression problem, mainly neural network, k-nearest neighbor, linear regression and basic support vector machine by applying different kernels, for example, dot, radial, neural, anova, and epachnenikov. Figure 8 represents the flowsheet of the methodology used on Rapidminer to compare the different mentioned algorithms.



**Figure 8.** Regression comparative on RapidMiner.

## 7. Results and Discussion

Based on the developed state of the art, the most used algorithms in power transformer failures classification, the best selected algorithms are tested on three dissolved gas analysis datasets with different inspections. This section describes the datasets used to validate the selected models, to be embedded in the hybrid artificial intelligence architectures. Then discussing the results of each model applied on the three discussed datasets. The best selected models are introduced and explained in detail. In order to present the results of these selected models, it is mandatory to describe the datasets, the model architecture, and the hybrid interactions.

### 7.1. Datasets Description

The goal of this section is to well describe the used dataset used to develop the models and discuss the advantages and limitations, including the best practices that should be taken into consideration in the online monitoring and the data recording while imbedding the hybrid artificial intelligence architecture, all datasets are shared in the Supplementary Materials.

#### 7.1.1. Classification Failures Dataset and Labels

These two datasets contain the dissolved gas analysis data in the transformer's fault state and the related fault type or label; in each dataset, various inspections were performed. Because the oil-paper insulation system in power transformers operates under the effects of high temperature and strong electromagnetic environment, and the insulation medium can slowly decompose into gases dissolved in oil, primarily H<sub>2</sub>, CH<sub>4</sub>, C<sub>2</sub>H<sub>6</sub>, C<sub>2</sub>H<sub>4</sub>, C<sub>2</sub>H<sub>2</sub>, and CO, when a failure occurs, the insulation breaks down more quickly and the decomposition products differ depending on the type and severity of the fault. The first dataset contains five gases and was examined in seven failures, resulting in five inputs and seven labels [20]. However, the second dataset has six gases and four inspections, therefore six inputs and four labels [21].

Figure 9 represents the correlations between the inputs (gases) of both datasets using the scattering graph. As represented in the six gas dataset, the failures can be visually

clustered for easy classification because the number of inputs is higher than the number of labels. However, in the five gas dataset, it is hard to cluster the data visually, which will make it hard to implement a machine learning model. Both scatter graphs are showing that there is not a high correlation between the inputs, which means that each input is impacting the labels in different behaviors, so no input elimination would be needed. Figure 10 describes the different labels of both datasets; the failures are mentioned previously in the power transformer monitoring techniques section. The six gas dataset has four labels, based on the number of particles per million (ppm) of each gas. High and low intensity discharge with 32 records each, totaling 64 records, thermal fault with 36 records, and 100 records of no-fault mean the dataset is clearly clean and requires no changes. In the five gas dataset, seven labels are inspected, with 82 records of four levels of temperature overheating after analyzing the four temperature levels and three levels of discharges (spark, partial, and arc discharge). It is recommended to use fuzzy logic-based algorithms to predict the level of temperature; however, with the set of input, it is very difficult to find a fit pattern.

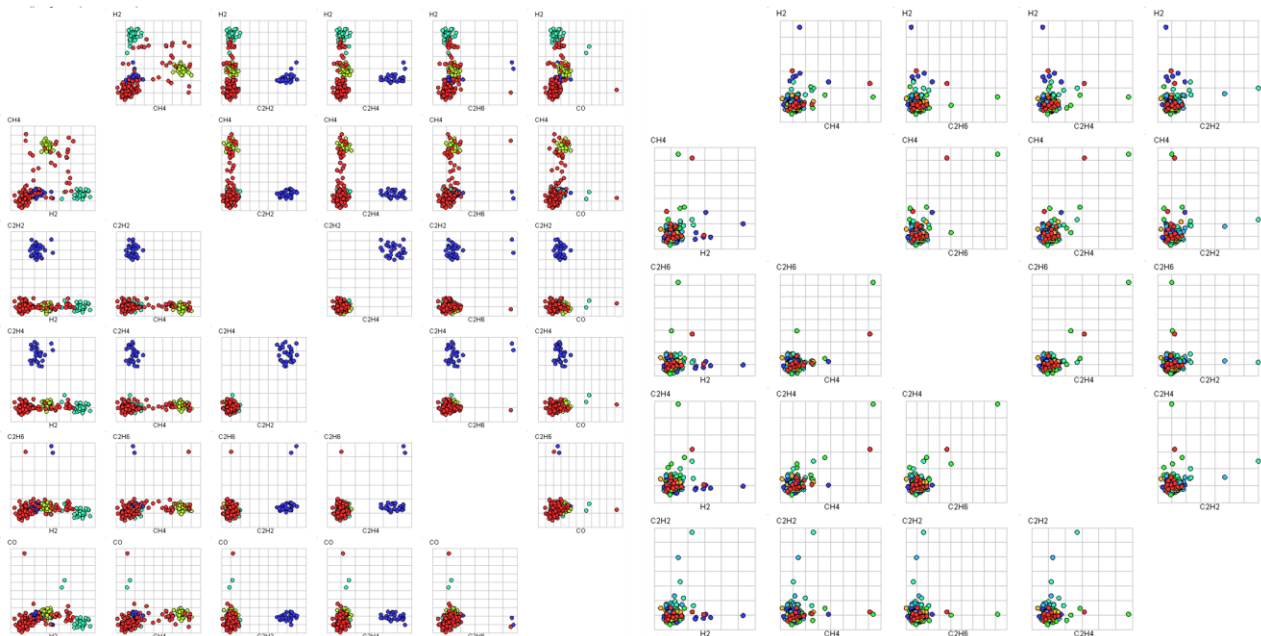

Figure 9. Dissolved gas analysis datasets 5 gas and 6 gas.

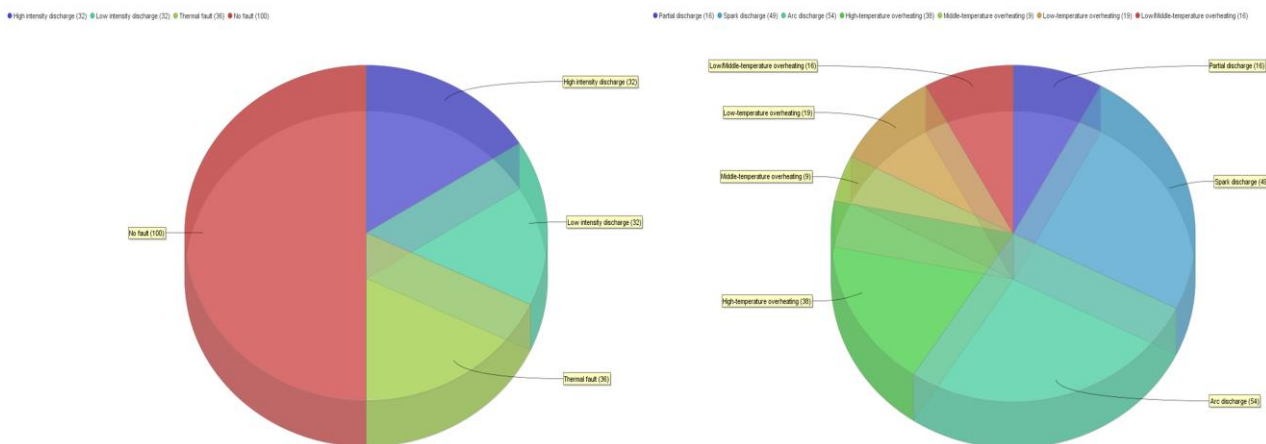
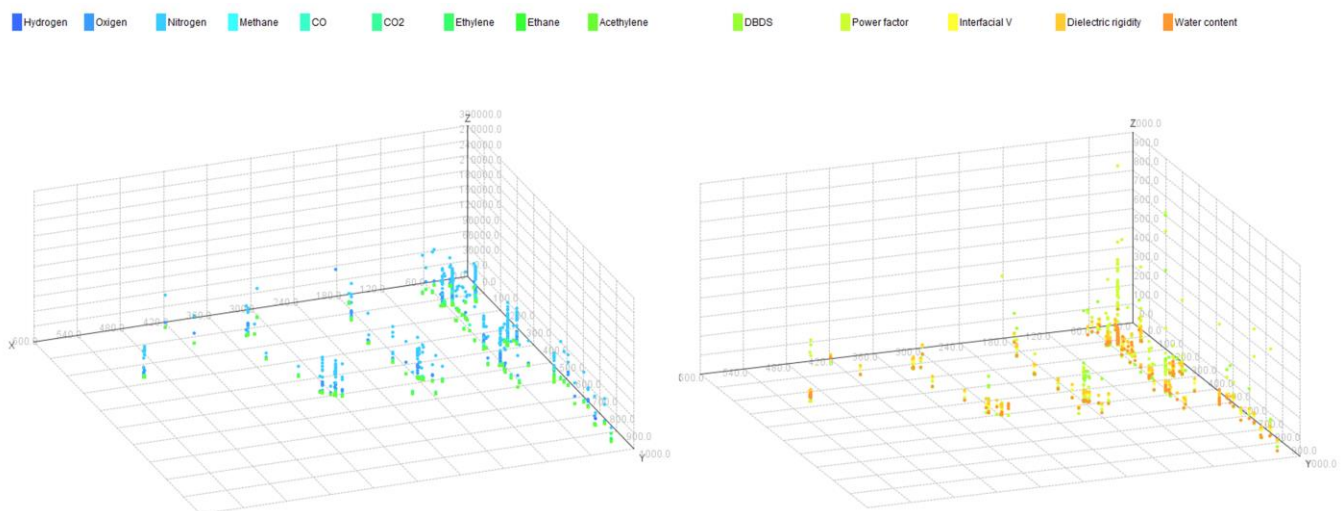

Figure 10. Dataset failures labels.

### 7.1.2. Health Index and Life-Loss Estimation Dataset

The used dataset is the result of a root cause analysis improved by machine learning presented by Ricardo [63], integrating nine gas dissolved gas analysis including hydrogen, oxygen, nitrogen, methane, CO, CO<sub>2</sub>, ethylene, ethane, acetylene, dibenzyl disulfide and electrical data integrating power factors, interfacial voltage, dielectric rigidity and the water content. The main outputs of this dataset are life loss and the overall Health Index of the power transformer; therefore, the goal of this section is to find the best two-fit models to estimate separately the Health Index and the life loss.

Figure 11 shows two 3D scattering graphs of the DGA dataset and the two targeted outputs and the other inputs separately because the goal is to only use dissolved gas analysis in the hybrid architecture; however, no correlations have been found and therefore it is mandatory to enter all inputs in both models.



**Figure 11.** Health Index and life loss database.

## 7.2. Algorithms Performance of 5 Gas Dataset

In this section, a comparison of the tested algorithms based on the model accuracy, relative error, root mean squared error, root relative squared error, and the squared error because these are the best indicators for the classification problem.

### 7.2.1. Results and Discussion

After testing, random tree, random forest, decision strom, and decision tree, which are showing very low accuracies from 29.77% to 46.43%, are applied to the grid optimizer bloc to find the best set of parameters, number of trees, number of leaves, number of depth of the results that stay always very low and unsatisfying; however, optimizing the random forest the accuracy has been up to 73.17%, but the relative error stays very high comparing to the k-nearest neighbor (KNN). The KNN algorithm shows better results, from 53.66% to 70.73%, and Table 2 shows the comparative study between the algorithms revealing the accuracy and all error metrics.

In the second step of testing the particle swarm optimized support vector machine (PSO-SVM) has shown far better results from the previous models. Therefore, it was necessary to test other kernels and optimizer, and all kernels have shown good results except for the multiquadric kernel, the best are the radial and epachnenikov kernels with slight differences in accuracy. The result has shown the evolutionary optimized SVM with radial kernel has the best accuracy of 85.95% with acceptable errors, which is very understandable because of the quality of the dataset, i.e., the number of inputs was lower than the number of labels and the dataset is quite small. However, with this accuracy, it is good to integrate in the hybrid architecture to validate the proposed system knowing that

the model based on the six gas four label dataset will correct and enhance the decisions made by this model. The interactions with the human agent which are the inspectors the maintenance technicians and the laboratory testing agent will criticize the result and correct the label, entering it in the system in the offline layers, and after gathering more data the model shall be improved.

**Table 2.** 5 Gas dataset comparative results.

Tested Algorithms 5GAS-7Labels	Accuracy	Relative Error	Root Mean Squared Error	Root Relative Squared Error	Squared Error
Random Tree	43.90%	67.82%	0.701	0.471	0.492
Random forest	48.78%	66.62%	0.699	0.47	0.489
Decision stump	29.27%	78.86%	0.803	0.54	0.644
Decision tree	46.43%	62.84%	0.715	0.481	0.512
KNN	53.66%	56.34%	0.681	0.458	0.463
K-Grid-Optimized-KNN	70.73%	55.74%	0.588	0.395	0.346
K-Grid-Optimized-Random Forest	73.17%	63.56%	0.65	0.437	0.423
SVM-PSO Radial Kernel	85.71%	37.12%	0.39	0.9	0.15
SVM-PSO Multiquadric Kernel	21.67%	78.33%	0.88	2.21	0.73
SVM-PSO Epachnenikov Kernel	75.24%	50.00%	0.5	1.22	0.25
SVM-PSO Anova Kernel	69.29%	46.34%	0.48	1.14	0.22
<b>SVM-Evolutionary Radial Kernel</b>	<b>85.95%</b>	<b>48.20%</b>	<b>0.48</b>	<b>1.17</b>	<b>0.23</b>
SVM-Evolutionary Multiquadric Kernel	28.81%	71.19%	0.84	2.11	0.71
SVM-Evolutionary Epachnenikov Kernel	85.71%	48.53%	0.49	1.18	0.24
SVM-Evolutionary Anova Kernel	85.48%	44.51%	0.45	1.09	0.2

### 7.2.2. Selected Algorithm: SVM Evolutionary Radial Kernel

The support vector machine (evolutionary), which uses an evolutionary strategy for optimization, is the best fit algorithm. This operator is an SVM implementation that solves the dual optimization issue of an SVM using an evolutionary method. On many datasets, this basic approach turns out to be as quick and accurate as traditional SVM implementations. Using the radial kernel described in Equation (1), where  $\gamma$  is the gamma, it is specified by the kernel gamma parameter. The adjustable parameter gamma plays a major role in the performance of the kernel and should be carefully tuned to the problem at hand.

$$K(x, y) = e^{-\eta \sum_{j=1}^p (x_{ij}y_{ij})^d} \quad (1)$$

where  $\eta$  here is a tuning parameter which accounts for the smoothness of the decision boundary and controls the variance of the model. If  $\eta$  is very large, then we get quiet fluctuating and wiggly decision boundaries, which accounts for high variance and overfitting. If  $\eta$  is small, the decision line or boundary is smoother and has low variance. So now the equation of the support vector classifier becomes (2), where  $S$  are the support vectors and  $\alpha$  is simply a weight value which is non-zero for all support vectors and otherwise 0.

$$f(x) = \beta_0 + \sum_{i \in S} \alpha_i K(x_i, y_i) \quad (2)$$

Figure 12 represents the results of the selected model, showing the scatters between the labels, the counter, the function value, the alpha value, and the support vector. Therefore, no variable has high impact on the label, meaning that all inputs have different impacts on the label. However, it is mandatory to test the same algorithm on the six gas dataset with fewer labels and restudy the accuracy of the model.

In the implementation phase of the proposed architecture, it would be perfect to design a return system that records all the results of the algorithm while comparing it to the other dissolved gas-based models in order to look for correlations in the first place and to correct the labels integrating the human agent interactions with the system. With more data from both software and human agents, it would be the time to develop a reinforcement learning model to enhance the current proposed SVM model [73].

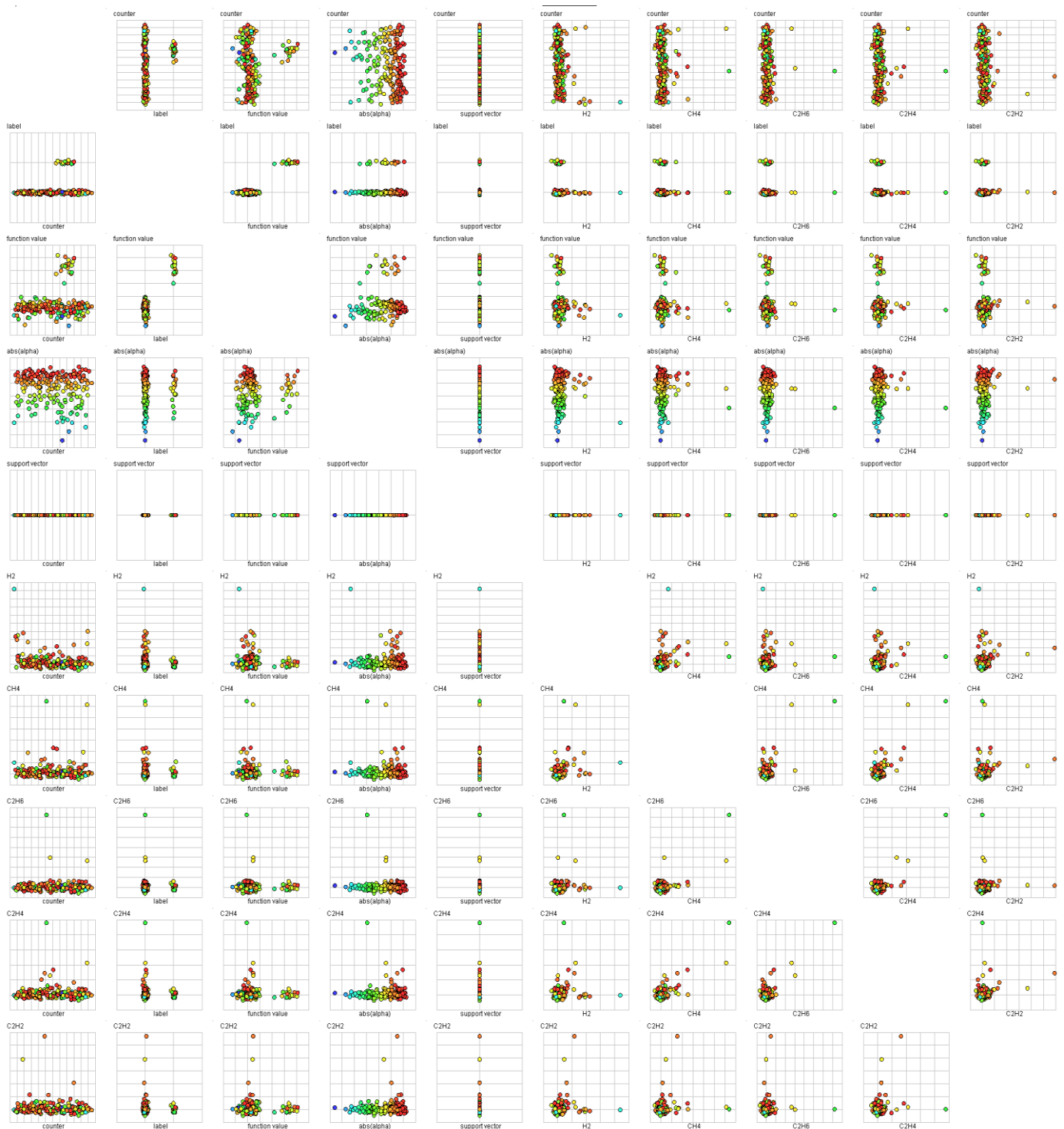

**Figure 12.** Evolutionary support vector machine results scatter.

### 7.3. Algorithms Performance of 6 Gas Dataset

The goal of this section is to select the best model to classify three general power transformer faults, high discharge intensity, low discharge intensity, and thermal fault, based on a six gas. Following the same approach in the previous section, to select the best fit model, the comparison is based on accuracy, relative error, root mean squared error, root relative squared error, and the squared error.



### 7.3.1. Results and Discussion

As represented in the Rapidminer flowchart shown in Figure 9, the goal is to compare the main classification algorithms, using the grid optimizer in order to find the best set of the model parameters to oversee the best performance of each algorithm. Table 3 shows the results where the support vector machine used in the previous classification problem has accuracies between 73.75% and 97.50% for all kernel in both particle swarm optimizer and evolutionary optimization, except for the multiquadric function, which shows very bad results from 23% to 36%.

**Table 3.** 6 Gas dataset comparative results.

Tested Algorithms 6Gas-4Labels	Accuracy	Relative Error	Root Mean Squared Error	Root Relative Squared Error	Squared Error
Random Tree	89.74%	10.81%	0.381	0.302	0.101
<b>Random forest</b>	<b>100.00%</b>	<b>4.57%</b>	<b>0.093</b>	<b>0.088</b>	<b>0.009</b>
Decision stump	66.67%	47.41%	0.544	0.518	0.296
Decision tree	100.00%	0.00%	0	0	0
KNN	100.00%	0.00%	0	0	0
Neural Network	94.87%	7.02%	0.222	0.211	0.049
SVM-PSO Radial Kernel	73.75%	44.89%	0.45	1.25	0.21
SVM-PSO Multiquadric Kernel	36.88%	63.13%	0.77	2.43	0.63
SVM-PSO Epachnenikov Kernel	76.25%	47.56%	0.48	1.33	0.23
SVM-PSO Anova Kernel	97.50%	38.31%	0.39	1.09	0.15
SVM-Evolutionary Radial Kernel	83.13%	45.13%	0.46	1.25	0.21
SVM-Evolutionary Multiquadric Kernel	23.75%	76.25%	0.87	2.57	0.76
SVM-Evolutionary Epachnenikov Kernel	78.13%	46.99%	0.47	1.31	0.23
SVM-Evolutionary Anova Kernel	97.50%	37.57%	0.38	1.06	0.15

The neural network is showing a good accuracy of 94.87% with a very satisfying relative error of 7.02%, and the random tree shows good results of 89.74% accuracy but stays not the best comparing to the neural network. However, the neural network could be very useful to test in future datasets gathered by the proposed architecture the only constraint is to find the optimal hyperparameters set using either metaheuristic algorithms or other optimizers.

The decision tree and the k-nearest neighbor are showing 100% accuracy with 0 errors, and these two algorithms are over-fitted, However the random forest which was optimized using the grid optimizer shows the best results accuracy of 100% with the best relative error of 4.57% and squared error of 0.009.

### 7.3.2. Model Description: Random Forest

As shown in the previous section, the best selected algorithm is the random forest, which is a concurrency-based algorithm; random forest is an ensemble of a certain number of random trees, specified by the number of trees parameter. These trees are built/trained using bootstrapped subsets of the example set supplied at the input port.

A tree node represents a splitting rule for a single attribute. To apply this model, the grid optimizer was used to choose the optimal set of parameters for the parameters number of trees, maximal depth, and leaf size. Using the apply model operator, the random forest model may be applied to new examples once it has been generated. Each random tree makes a forecast for each example by following the branches of the tree and assessing the leaf in accordance with the splitting criteria.

Class predictions are based on the majority of examples, whereas estimations are based on the average of values reaching a leaf. The resultant model is a voting model of all randomly generated trees. Because all single forecasts are treated identically and are based on subsets of examples, the resultant prediction tends to vary less than the single predictions.

A concept called pruning can be leveraged to reduce complexity of the model by replacing subtrees, that only provide little predictive power with leave. Figure 13 represents the graph of the random forest, classification decisions, shown the threshold of each gas to

make the decision about the intensity of the discharge, with the existence of the thermal fault or the no fault.

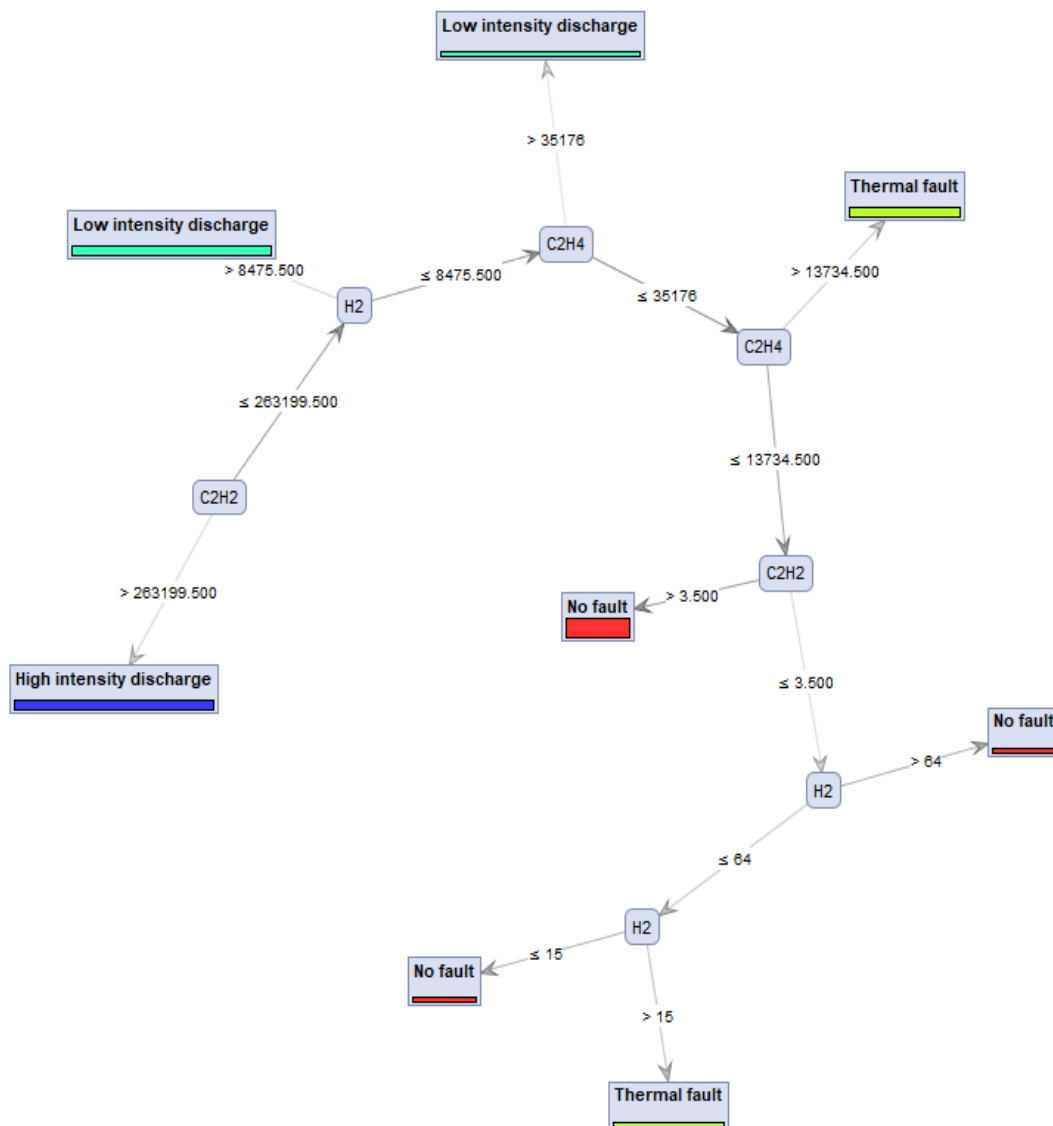

Figure 13. Random forest model graph.

#### 7.4. Life Loss Estimation

After selecting the classification algorithms, to determine the degrees of thermal or the discharge failures, which is the diagnostic part of the hybrid artificial intelligence layer, it is mandatory to calculate or to estimate the life loss of the power transformer. Therefore, this section gives an overview of the performance of multiple regression algorithms, based on the dataset presentation in Figure 10, and the goal is a regression problem with one target and 14 inputs.

##### 7.4.1. Results and Discussion

The used algorithms are mainly neural network, linear regression, and support vector machine, with no optimization, and k-nearest neighbor, which are all showing good results with practically close errors. The best selected algorithm is the k-nearest neighbor, with relatively low errors and better accuracy compared to other algorithms. Table 4 shows the different errors mainly, root mean squared error, where in the regression problem it is not possible to calculate the accuracy of the model. The estimation of the life loss of the power transformer stays debatable.

**Table 4.** Life loss algorithms comparative results.

Tested Algorithms Life Loss	Root Mean Squared Error	Absolute Error	Normalized Absolute Error	Squared Error
Neural Network	116.039	50.719	0.737	13,465.07
<b>KNN</b>	<b>111.728</b>	<b>71.048</b>	<b>1.033</b>	<b>12,483.2</b>
Linear Regression	114.833	72.274	1.05	13,186.68
dot kernel SVM	114.571	49.665	0.722	13,126.6
Radial kernel SVM	115.495	50.23	0.73	13,339.08
Neural Kernel SVM	116.527	56.437	0.82	13,578.48
Anova Kernel SVM	114.719	49.653	0.722	13,160.44
Epachnenikov Kernel SVM	115.659	50.454	0.733	13,376.93

Therefore, the results shown in this paper are basically based on other estimations performed by power transformer experts, where the goal of the proposed architecture is to correct these estimations through the integration of the expert comments in all different layers, to enhance the learning models, and to improve the metrics of the life loss. This proposed estimation model is not the best, but it needs to be reinforced by experts labeling in a real case data driven model.

#### 7.4.2. Model Description: K-NN

The k-nearest neighbor method compares an unknown example to the k training examples that are the unknown example's nearest neighbors. Finding the k nearest training Examples is the first step in applying the k-nearest neighbor algorithm to a new example. "Closeness" is defined as a distance in n-dimensional space, as described by the n attributes in the training examples. To determine the distance between the unknown example and the training examples, many metrics, such as the Euclidean distance, can be utilized. Because distances frequently depend on absolute values, it is advised that data be normalized before training and implementing the k-nearest neighbor method. In order to optimize the parameters of this model, a grid optimization was used to find the optimal k combined applying the Euclidean distance for this example.

#### 7.5. Health Index Estimation

After classifying the failures and estimating the life loss of the power transformer, the proposed hybrid intelligence system must systematically estimate the Health Index based on all different acquired data; in this case and in order to validate the proof of concept of the architecture, this paper proposes a comparison between machine learning algorithms based on the same dataset used in the life loss section.

##### 7.5.1. Results and Discussion

Table 5 shows the results of the tested algorithms, which are all showing good results, testing neural networks, k-nearest neighbor, support vector machine with different kernel, and linear regression, which shows the least root mean squared error.

**Table 5.** Health Index algorithms comparative results.

Tested Algorithms Health Index	Root Mean Squared Error	Absolute Error	Normalized Absolute Error	Squared Error
Neural Network	223.431	131.808	0.863	49,921.43
KNN	176.039	125.643	0.822	30,989.86
<b>Linear Regression</b>	<b>173.713</b>	<b>112.349</b>	<b>0.735</b>	<b>30,176.4</b>
dot kernel SVM	201.438	122.225	0.8	40,577.39
Radial kernel SVM	221.328	131.114	0.858	48,986.25
Neural Kernel SVM	175.728	114.246	0.748	30,880.36
Anova Kernel SVM	213.16	128.1	0.838	45,437.39
Epachnenikov Kernel SVM	223.362	131.686	0.862	49,890.74

### 7.5.2. Model Description: Linear Regression

The best method examined with the lowest error is the linear regression algorithm, which is a technique used for numerical prediction. Linear regression attempts to model the relationship between a scalar variable and one or more explanatory variables by fitting a linear equation to observed data. Regression is a statistical measure that attempts to determine the strength of the relationship between one dependent variable and a series of other changing variables known as independent variables. Applying this model, a grid optimizer was used to identify the best parameters of the model, mainly alpha parameters, while the feature was set to greedy, and optimizing the max iterations in order to decrease the time of learning. However, the calculation of the Health Index stays debatable and not exact, based only on the dissolved gas analysis, power factor, water content, and interfacial voltages. Therefore, all developed models cannot estimate the exact Health Index of the power transformer, so the hybrid architecture proposed an online recording system from different agents, hardware agents which are the pure unprocessed data from sensors, software agents which are all developed estimation models.

## 8. Hybrid System Proposition

This section describes the interactions between the hardware, software, and human agent in order to keep the power transformer in a healthy condition, improve the accuracy of failure detection, improve the Health Index and life loss estimation and to supervise the principal factors and key performance indicators. To summarize the results of the developed models which stay very dependable on the exploited datasets but are not exact, the developed models are only for validating a proof-of-concept of the hybrid artificial intelligence. As presented in Figure 14, all tested algorithms are practically close to fit the problem, either the Health Index, life loss estimation, or the failure classification, the results are shared in the Supplementary Materials with the project file of the RapidMiner software. There is never a problem of what model should be used to estimate or to classify because it is very dependable on the used dataset, and it is a problem of how experts can use the presented model in an easy and effective way to enhance the health of the power transformer and to maintain it in the best conditions. So, to validate a proof of concept of the call in the architecture, i.e., the software agents, it is preferable to imbed these four algorithms and integrate a reinforcement learning method [74] into the system to correct the models considering the experts or the human agent comments.

### 8.1. Power Transformer KPI and Monitoring Dashboard

In this section a set of key performance indicators of the smart power transformer are introduced in order to develop an example of interactive dashboard so the users or the supervisors can monitor the state of the power transformer.

Figure 15 presents an example of power transformer monitoring dashboard, developed using the Thingsboard platform, which is an open source Internet of Things platform for device management, data collection, processing, and visualization. The platform is connected to PostgreSQL Database, where all acquired data from hardware agents are found, meaning sensors, power meters and all installed kits on the power transformer and also data resulting from the software agents, meaning the developed machine learning models.

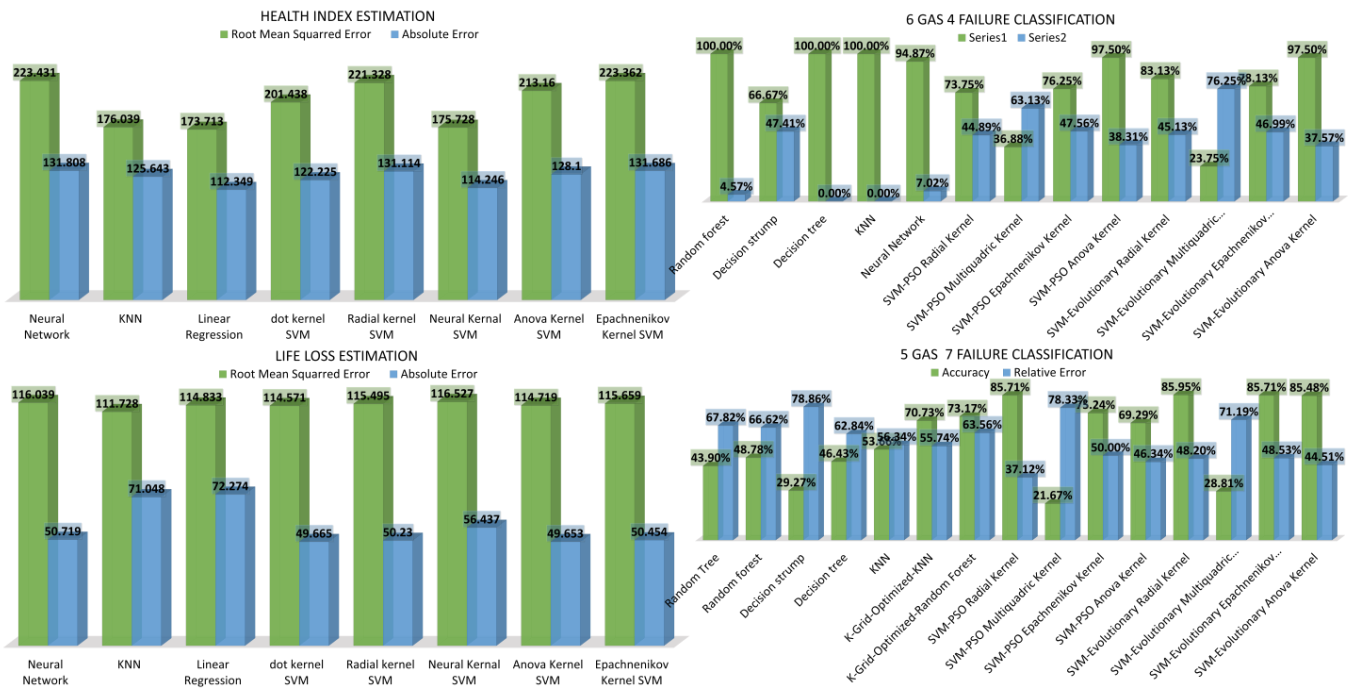

Figure 14. Tested algorithms results summary.

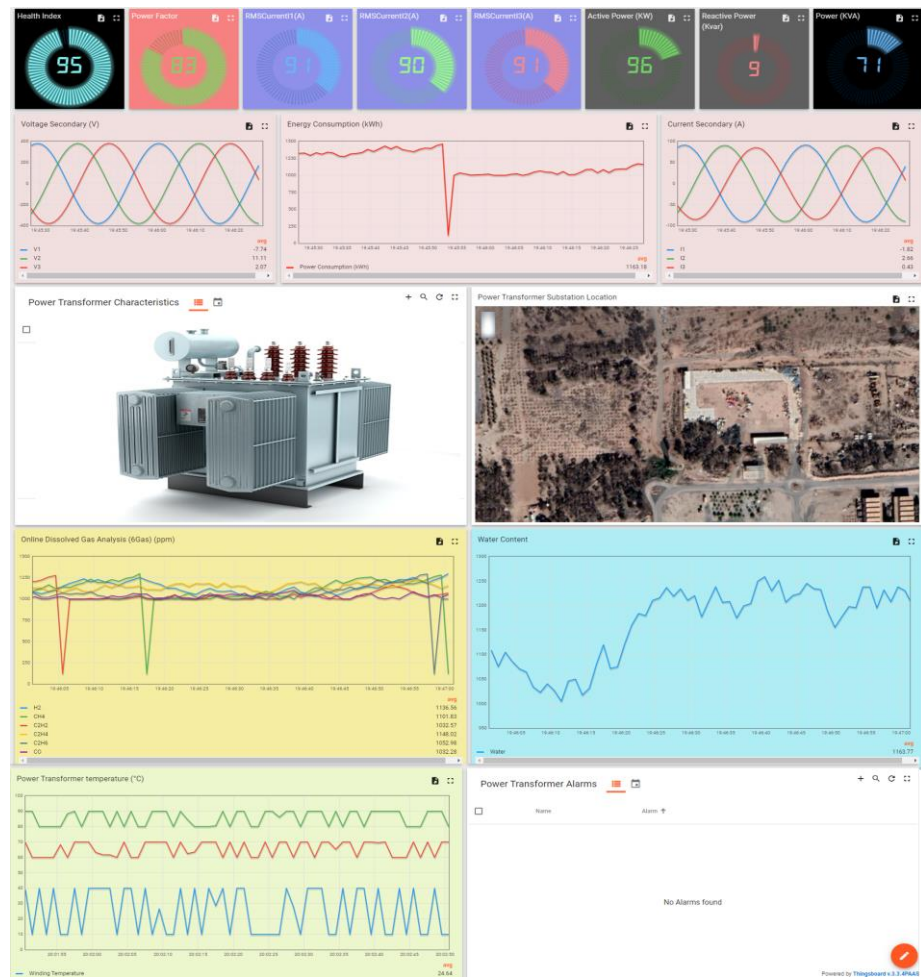

Figure 15. Online monitoring interface (Thingsboard).

Integrating tables in the database, adding more fields in the monitoring dashboard for experts commenting and labeling, and also for the maintenance planning, scheduling and alarms. In the developed dashboard, it is necessary to add all different KPI discussed in this section, for example:

#### 8.1.1. Health Index

The Health Index (HI) is a measure that could be used to assess the overall condition of a power transformer. This value is derived using some of the most representative variables of state or diagnostic that describe the activity and status of the transformer, and it is converted into a quantitative index that gives insight about its health status [75]. The necessity to assess the influence of individual findings from tests performed on the technical state of the transformer and the aging process progression is the motivation for developing a Health Index.

The process entails combining findings from operational inspections, examinations, and field and laboratory testing as well as assigning an objective and quantitative score to each result in order to determine the asset's overall health [7].

#### 8.1.2. Life Loss

Transformer life expectancy mostly depends on the insulation that is put in place to protect it from heat losses. Throughout the lifespan of the transformer, a number of abnormal circumstances, such as insulation defects, overloading, and winding shorting, will happen, which alters the transformer's typical life span [27]. The life loss is a very informative indicator of the power transformer since it gives an obvious view of the power transformer state.

#### 8.1.3. Voltage

Relying on the different power system operating circumstances, load variations cause transformer voltage fluctuations. The efficient operation of the transformer is ensured by properly monitoring the load status with regard to the transformer, which may be accounted for by the voltage monitoring.

#### 8.1.4. Current

By creating a reference wave signal and using various frequency analysis techniques on it, it is possible to analyze the signal and find flaws in the power transformer. The signal is examined to look for flaws in the transformer, with a focus on the current waveforms that are most susceptible to defects. The two main types of frequency analysis techniques are Fourier analysis and Wavelet analysis.

#### 8.1.5. Power Factor

The power factor is utilized to identify the transformer bushing modes of failure of short circuit across bushing layers caused by moisture, carbonization of insulation, faulty bushings, and pollution of oil by dissolved substances or conducting particles [26].

The power factor is an important indicator of the operations of the power transformer, and it could be considered among the key performance indicators to be monitored permanently, with the aim to correlate its behaviors with the power, voltage, temperature, and current graphs to have an informative analysis.

#### 8.1.6. DGA Graph

Due to the melting of insulation winding into the transformer's cooling oil, the presence of various gasses can be seen in the oil tank of the transformer at an early stage. Different types of faults happening in the transformer can be represented by the ratio of these various gasses present [27] because of the conversion of winding material into winding oil determines the sort of gas recovered and its nature. The faults could be determined

by the conventional ratio methods or by applying the artificial intelligence algorithms, where the necessity to monitor and acquire DGA exists.

#### 8.1.7. Water Content Graph

Transformer oil may unintentionally contain water throughout any step of production, from design to commissioning. Additionally, despite the transformer cabinet's airtight construction, moisture may enter during transit, operating, and overhaul because the covers and bushings are not properly closed. Free water in transformer oil will negatively impact the oil-paper insulation system's shielding effectiveness, speed up aging, and significantly reduce insulation life, including processes such as vacuum drying, vacuum oil injection, and hot oil flow, and must be used to remove water from the transformer oil in order to reduce its water content [76]. To keep an eye on this critical indicator, a graph of water content in the power transformer must be added to the dashboard.

#### 8.1.8. Temperature Graph

Overvoltage is correlated with an elevation in the windings' demand for dielectric insulation and a rise in temperature. Short-lived overvoltages, which happen at intervals on the order of microseconds, are challenging to identify, and their harms are brought on by high voltage arcs. Therefore, temperature rises are the outcome of long-term overvoltage [77]. On the other hand, temperature monitoring of the power transformer is primordial, while it is a key indicator of the instantaneous state and reflects an image of a wide range of defects.

#### 8.1.9. Alarms

The alarms are to bring to the front of the monitoring system since they are the first trigger of the urgent procedures for preventing serious failures, and, on the other hand, to inform about any abnormal behavior of the power transformer or the exceeding of normal functioning values of its parameters.

#### 8.1.10. Maintenance Schedule

The Health Index (HI) output can serve as the primary input for maintenance scheduling since it offers categories of HI values that connect the current state of the transformer to the needed maintenance operation [26], and it places an emphasis on identifying power transformer in-service problems and inadequacies that require effective maintenance or rehabilitation to keep the asset in continuously operational condition.

### 8.2. Agents Interactions in the Proposed Architecture

This section discusses the interactions between, software, hardware, and human agents in the different in the developed hybrid layered architecture used in other smart grid applications [78]. Figure 16 describes these interactions where hardware agents are collecting data from the online sensors (for example, the installed gas sensors, temperature, vibration, thermal cameras, and others). Many power transformer components can be introduced as hardware agents (for example, winding, tank) and therefore any inspection or monitoring added to the power transformer is a hardware agent for the architecture. The software agent interacts in many layers discussed previously in the general architecture shown in Figure 6, for example in estimating the Health Index and the life loss, predicting or diagnosing the power transformer, and also the software agent is recording or modeling results while taking into account the comments of the human agent in a reinforcement learning model to improve the accuracy of the discussed model or others.

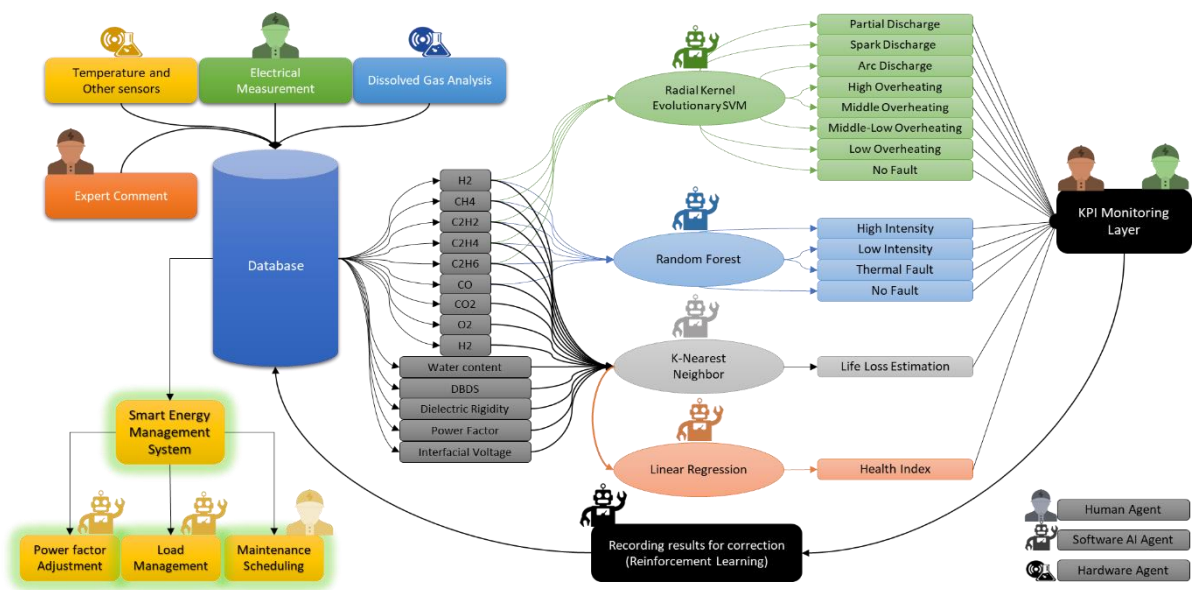

Figure 16. Multi agent interactions in the proof-of-concept architecture.

The software agent, with the help of the human agent, is taking decisions on the load priority management within the smart energy management system after obtaining inputs from the database. While managing the load priority the power factor is changing, therefore, the model is estimating new values of the Health Index and the life loss [79] with the supervision of the human agents in the monitoring station and in the electrical measurements stage, meaning that in order to obtain the best value, the software agent proposes new sets of power factor adjustment for the human agent to validate.

Based on this proposed architecture, the human agent interferes in practically all levels from measuring, labeling, monitoring, and decision-making; however, all the decisions and inspection behaviors of human agents are being recorded in a database and can be processed in future deep learning models to standardize their interventions and hopefully minimize it in order to make the power transformer fully autonomous, which is theoretically impossible for now.

## 9. Conclusions

After the latest changes in the demand response or the load profile in the grid, integrating massive renewables, electric vehicles, and energy storage systems, followed by the energy digital transition and the use of smart sensors in smart grids, the main critical equipment, the power transformer, must become smarter and be enhanced by smart features, for example, auto-diagnostics, failure prediction, communication, and others in order to answer the demand response of the grid and increase the availability preventing critical failures, blackouts, and explosions. Therefore, the paper presented a novel hybrid artificial intelligence-layered multi-agent architecture [80] by firstly analyzing the features needed in the power transformer and listing the main critical failures, causes, and inspection using the ISHIKAWA methodology. The next step was discussing the different monitoring and inspection techniques of the power transformer in order to be integrated in the proposed architecture. After the analysis complete, the state of the art was proposed about the use of machine learning algorithms in power transformer case studies based on different monitoring techniques, and it was clear that the dissolved gas analysis was the best base to detect the failures and to estimate the life loss and the Health Index.

By proposing a general layered architecture which integrates online and offline monitoring techniques, each layer is communicating with the higher layer by a human, hardware, or software agent in order to record, analyze, pre-process, label data, then classifying the different failures and giving prognostics, with alarms showing a monitoring dashboard.



This architecture is communicating with a smart energy management system distributed in the grid that decide on loads scheduling, with power factors adjusting and maintenance planning with the help of human agents [81]. In order to validate this architecture for prognostic health management, especially the software agents, an exhaustive list of algorithms testing the classification of general failures, such as thermal fault or discharges in different levels, have shown results indicating that the use of five gas dissolved gas analysis can classify four levels of temperature overheating and three levels of discharges with an accuracy of 85.95% using the support vector machine optimized by evolutionary algorithms with the radial kernel, followed by the six gas dissolved gas analysis can classify two levels of discharge and detect the thermal fault using the random forest with accuracy of 100%. However, these algorithms are not the best because they stay very dependable on the dataset.

The same goes for estimating the Health Index and the life loss using k-nearest neighbor and the linear regression algorithms, which were the best comparing to other regression machine learning algorithms with slight differences in the error metrics. Although it is very dependable on the dataset and it was never a question of which model should be used, it was rather a question of how experts can use models in an easy and effective manner to keep the power transformer healthy, which is why the interactions between the software, hardware, and human agents in the architecture for prognostic health management are mandatory in order to make the power transformer smarter and gather more data which can be used to make the transformer fully autonomous after improving the deep reinforcement learning model that replaces or mimic the human agent decisions which will be developed in future work enhancing also the estimation of the Health Index and the life loss of the power transformer.

**Supplementary Materials:** The following supporting information can be downloaded at: <https://www.mdpi.com/article/10.3390/en15197217/s1>, The supplementary material folder contains a Datasets Folder: Contains 4 datasets, 5 Gas 7 Labels Dataset, 6 Gas 4 Labels Dataset, Health Index Scoring Dataset, Life Loss Calculation Dataset. Project in Rapidminer folder contains the different developed models with optimization, A comparative study of the results, and The Developed Monitoring Platform for Power Transformers using (Thingsboard).

**Author Contributions:** Conceptualization, O.L. and H.E.H.; methodology, O.L. and H.E.H.; software, O.L., H.E.H., A.E.M. and N.E.-B.; validation, A.C., M.B. and J.M.G.; formal analysis, A.C.; investigation, M.B.; resources, O.L.; data curation, O.L. and H.E.H.; writing—original draft preparation, O.L.; writing—review and editing, O.L. and A.E.M.; visualization, O.L.; supervision, H.E.H. and J.M.G.; project administration, M.B.; funding acquisition, A.C. All authors have read and agreed to the published version of the manuscript.

**Funding:** This research was funded by the Green Tech Institute of UM6P.

**Data Availability Statement:** Data is available on the site with datasets and resources using the RapidMiner Software Educational license.

**Acknowledgments:** This work is the result of research on Predictive maintenance of Power Transformer of the Green Tech Institute and OCP Morocco Experimental Mine of Benguerir Team and their industrial partners with collaboration of CROM.

**Conflicts of Interest:** The authors declare no conflict of interest.

## References

1. Godina, R.; Rodrigues, E.M.G.; Paterakis, N.G.; Erdinc, O.; Catalão, J.P.S. Innovative Impact Assessment of Electric Vehicles Charging Loads on Distribution Transformers Using Real Data. *Energy Convers. Manag.* **2016**, *120*, 206–216. [[CrossRef](#)]
2. Jimenez, H.; Calleja, H.; González, R.; Huacuz, J.; Lagunas, J. The Impact of Photovoltaic Systems on Distribution Transformer: A Case Study. *Energy Convers. Manag.* **2006**, *47*, 311–321. [[CrossRef](#)]
3. Godina, R.; Rodrigues, E.M.G.; Matias, J.C.O.; Catalão, J.P.S. Smart Electric Vehicle Charging Scheduler for Overloading Prevention of an Industry Client Power Distribution Transformer. *Appl. Energy* **2016**, *178*, 29–42. [[CrossRef](#)]
4. Da Silva, D.G.T.; Braga Da Silva, H.J.; Marafão, F.P.; Paredes, H.K.M.; Gonçalves, F.A.S. Enhanced Health Index for Power Transformers Diagnosis. *Eng. Fail. Anal.* **2021**, *126*, 105427. [[CrossRef](#)]

5. Yahaya, M.; Azis, N.; Ab Kadir, M.; Jasni, J.; Hairi, M.; Talib, M. Estimation of Transformers Health Index Based on the Markov Chain. *Energies* **2017**, *10*, 1824. [CrossRef]
6. El Hadraoui, H.; Zegrari, M.; Chebak, A.; Laayati, O.; Guennouni, N. A Multi-Criteria Analysis and Trends of Electric Motors for Electric Vehicles. *World Electr. Veh. J.* **2022**, *13*, 65. [CrossRef]
7. El Hadraoui, H.; Zegrari, M.; Hammouch, F.-E.; Guennouni, N.; Laayati, O.; Chebak, A. Design of a Customizable Test Bench of an Electric Vehicle Powertrain for Learning Purposes Using Model-Based System Engineering. *Sustainability* **2022**, *14*, 10923. [CrossRef]
8. Gorgan, B.; Notingher, P.; Badicu, L.-V.; Gabriel, T. Calculation of Power Transformers Health Indexes. *Ann. Univ. Craiova Electr. Eng. Ser.* **2010**, *34*, 13–18.
9. Foros, J.; Istad, M. Health Index, Risk and Remaining Lifetime Estimation of Power Transformers. *IEEE Trans. Power Deliv.* **2020**, *35*, 2612–2620. [CrossRef]
10. Naderian, A.; Cress, S.; Piercy, R.; Wang, F.; Service, J. An Approach to Determine the Health Index of Power Transformers. In Proceedings of the Conference Record of the 2008 IEEE International Symposium on Electrical Insulation, Vancouver, BC, Canada, 9–12 June 2008; pp. 192–196.
11. Laayati, O.; Bouzi, M.; Chebak, A. Design of an Oil Immersed Power Transformer Monitoring and Self Diagnostic System Integrated in Smart Energy Management System. In Proceedings of the 2021 3rd Global Power, Energy and Communication Conference (GPECOM), Antalya, Turkey, 5–8 October 2021; pp. 240–245. [CrossRef]
12. Leonori, S.; Martino, A.; Frattale Mascioli, F.M.; Rizzi, A. Microgrid Energy Management Systems Design by Computational Intelligence Techniques. *Appl. Energy* **2020**, *277*, 115524. [CrossRef]
13. Fofana, I.; Hadjadj, Y. Electrical-Based Diagnostic Techniques for Assessing Insulation Condition in Aged Transformers. *Energies* **2016**, *9*, 679. [CrossRef]
14. Laayati, O.; Bouzi, M.; Chebak, A. Smart Energy Management System: Design of a Monitoring and Peak Load Forecasting System for an Experimental Open-Pit Mine. *Appl. Syst. Innov.* **2022**, *5*, 18. [CrossRef]
15. El Maghraoui, A.; Ledmaoui, Y.; Laayati, O.; El Hadraoui, H.; Chebak, A. Smart Energy Management: A Comparative Study of Energy Consumption Forecasting Algorithms for an Experimental Open-Pit Mine. *Energies* **2022**, *15*, 4569. [CrossRef]
16. Agung, A.A.G.; Handayani, R. Blockchain for Smart Grid. *J. King Saud Univ.-Comput. Inf. Sci.* **2020**, *34*, 666–675. [CrossRef]
17. Laayati, O.; El Hadraoui, H.; Bouzi, M.; El-Alaoui, A.; Kousta, A.; Chebak, A. Smart Energy Management System: Blockchain-Based Smart Meters in Microgrids. In Proceedings of the 2022 4th Global Power, Energy and Communication Conference (GPECOM), Nevsehir, Turkey, 14–17 June 2022; pp. 580–585. [CrossRef]
18. Umar, A.; Kumar, D.; Ghose, T. Blockchain-Based Decentralized Energy Intra-Trading with Battery Storage Flexibility in a Community Microgrid System. *Appl. Energy* **2022**, *322*, 119544. [CrossRef]
19. Laayati, O.; El Hadraoui, H.; Guennoui, N.; Bouzi, M.; Chebak, A. Smart Energy Management System: Design of a Smart Grid Test Bench for Educational Purposes. *Energies* **2022**, *15*, 2702. [CrossRef]
20. Li, E. Dissolved Gas Data in Transformer Oil—Fault Diagnosis of Power Transformers with Membership Degree. *IEEE Access* **2019**, *7*, 28791–28798. [CrossRef]
21. Illias, H.A.; Chai, X.R.; Abu Bakar, A.H.; Mokhlis, H. Transformer Incipient Fault Prediction Using Combined Artificial Neural Network and Various Particle Swarm Optimisation Techniques. *PLoS ONE* **2015**, *10*, e0129363. [CrossRef]
22. Sample Power Transformers Health Condition Dataset. Available online: <https://www.kaggle.com/datasets/easonlai/sample-power-transformers-health-condition-dataset> (accessed on 25 July 2022).
23. Institute of Electrical and Electronics Engineers. *IEEE Guide for the Evaluation and Reconditioning of Liquid Immersed Power Transformers*; Institute of Electrical and Electronics Engineers: New York, NY, USA, 2007; ISBN 978-0-7381-5268-4.
24. Eslamian, M.; Vahidi, B.; Hosseinian, S.H. Analytical Calculation of Detailed Model Parameters of Cast Resin Dry-Type Transformers. *Energy Convers. Manag.* **2011**, *52*, 2565–2574. [CrossRef]
25. Laayati, O.; Bouzi, M.; Chebak, A. Smart Energy Management System: SCIM Diagnosis and Failure Classification and Prediction Using Energy Consumption Data. In *Digital Technologies and Applications*; Motahhir, S., Bossoufi, B., Eds.; Lecture Notes in Networks and Systems; Springer International Publishing: Cham, Switzerland, 2021; Volume 211, pp. 1377–1386. ISBN 978-3-030-73881-5. [CrossRef]
26. Murugan, R.; Ramasamy, R. Understanding the Power Transformer Component Failures for Health Index-Based Maintenance Planning in Electric Utilities. *Eng. Fail. Anal.* **2019**, *96*, 274–288. [CrossRef]
27. Chandran, L.R.; Ajith Babu, G.S.; Nair, M.G.; Ilango, K. A Review on Status Monitoring Techniques of Transformer and a Case Study on Loss of Life Calculation of Distribution Transformers. *Mater. Today: Proc.* **2020**, *46*, 4659–4666. [CrossRef]
28. Meng, J.; Singh, M.; Sharma, M.; Singh, D.; Kaur, P.; Kumar, R. Online Monitoring Technology of Power Transformer Based on Vibration Analysis. *J. Intell. Syst.* **2021**, *30*, 554–563. [CrossRef]
29. Jazebi, S.; Vahidi, B.; Jannati, M. A Novel Application of Wavelet Based SVM to Transient Phenomena Identification of Power Transformers. *Energy Convers. Manag.* **2011**, *52*, 1354–1363. [CrossRef]
30. Shutenko, O.; Kulyk, O. Recognition of Low-Temperature Overheating in Power Transformers by Dissolved Gas Analysis. *Electr. Eng.* **2022**, *104*, 2109–2121. [CrossRef]
31. Singh, J.; Singh, S. Transformer Failure Analysis: Reasons and Methods. *Int. J. Eng. Res.* **2016**, *4*, 5.

32. Hu, H.; Ma, X.; Shang, Y. A Novel Method for Transformer Fault Diagnosis Based on Refined Deep Residual Shrinkage Network. *IET Electr. Power Appl.* **2022**, *16*, 206–223. [[CrossRef](#)]
33. Raichura, M.B.; Chothani, N.G.; Patel, D.D. Identification of Internal Fault against External Abnormalities in Power Transformer Using Hierarchical Ensemble Extreme Learning Machine Technique. *IET Sci. Meas. Technol.* **2020**, *14*, 111–121. [[CrossRef](#)]
34. Zhang, X.; Fang, R.; Zhang, G.; Fang, Y.; Zhou, X.; Ma, Y.; Wang, K.; Chen, K. Research on Transformer Fault Diagnosis: Based on Improved Firefly Algorithm Optimized LPboost-Classification and Regression Tree. *IET Gener. Transm. Distrib.* **2021**, *15*, 2926–2942. [[CrossRef](#)]
35. Zhang, L.; Sheng, G.; Hou, H.; Zhou, N.; Jiang, X. An Adaptive Fault Diagnosis Method of Power Transformers Based on Combining Oversampling and Cost-Sensitive Learning. *IET Smart Grid* **2021**, *4*, 623–635. [[CrossRef](#)]
36. Kazemi, Z.; Naseri, F.; Yazdi, M.; Farjah, E. An EKF-SVM Machine Learning-Based Approach for Fault Detection and Classification in Three-Phase Power Transformers. *IET Sci. Meas. Technol.* **2021**, *15*, 130–142. [[CrossRef](#)]
37. Madavan, R.; Saroja, S. Decision Making on the State of Transformers Based on Insulation Condition Using AHP and TOPSIS Methods. *IET Sci. Meas. Technol.* **2020**, *14*, 137–145. [[CrossRef](#)]
38. Patel, D.; Chothani, N.G.; Mistry, K.D.; Raichura, M. Design and Development of Fault Classification Algorithm Based on Relevance Vector Machine for Power Transformer. *IET Electr. Power Appl.* **2018**, *12*, 557–565. [[CrossRef](#)]
39. Hernandez, G.; Ramirez, A. Dielectric Response Model for Transformer Insulation Using Frequency Domain Spectroscopy and Vector Fitting. *Energies* **2022**, *15*, 2655. [[CrossRef](#)]
40. Kim, M.; Lee, S. Power Transformer Voltages Classification with Acoustic Signal in Various Noisy Environments. *Sensors* **2022**, *22*, 1248. [[CrossRef](#)]
41. Odongo, G.; Musabe, R.; Hanyurwimfura, D. A Multinomial DGA Classifier for Incipient Fault Detection in Oil-Impregnated Power Transformers. *Algorithms* **2021**, *14*, 128. [[CrossRef](#)]
42. Senoussaoui, M.E.A.; Brahami, M.; Fofana, I. Transformer Oil Quality Assessment Using Random Forest with Feature Engineering. *Energies* **2021**, *14*, 1809. [[CrossRef](#)]
43. Ghoneim, S.S.M. Determination of Transformers' Insulating Paper State Based on Classification Techniques. *Processes* **2021**, *9*, 427. [[CrossRef](#)]
44. Lee, C.-T.; Horng, S.-C. Abnormality Detection of Cast-Resin Transformers Using the Fuzzy Logic Clustering Decision Tree. *Energies* **2020**, *13*, 2546. [[CrossRef](#)]
45. Zou, J.; Chen, W.; Wan, F.; Fan, Z.; Du, L. Raman Spectral Characteristics of Oil-Paper Insulation and Its Application to Ageing Stage Assessment of Oil-Immersed Transformers. *Energies* **2016**, *9*, 946. [[CrossRef](#)]
46. Laayati, O.; Hadraoui, H.E.; Bouzi, M.; Chebak, A. Smart Energy Management System: Oil Immersed Power Transformer Failure Prediction and Classification Techniques Based on DGA Data. In Proceedings of the 2022 2nd International Conference on Innovative Research in Applied Science, Engineering and Technology (IRASET), Meknes, Morocco, 3–4 March 2022; pp. 1–6. [[CrossRef](#)]
47. Shintemirov, A.; Tang, W.; Wu, Q.H. Power Transformer Fault Classification Based on Dissolved Gas Analysis by Implementing Bootstrap and Genetic Programming. *IEEE Trans. Syst. Man Cybern. Part C (Appl. Rev.)* **2009**, *39*, 69–79. [[CrossRef](#)]
48. Hao, X.; Cai-Xin, S. Artificial Immune Network Classification Algorithm for Fault Diagnosis of Power Transformer. *Power Deliv. IEEE Trans.* **2007**, *22*, 930–935. [[CrossRef](#)]
49. Xing, M.; Ding, W.; Li, H.; Zhang, T. A Power Transformer Fault Prediction Method through Temporal Convolutional Network on Dissolved Gas Chromatography Data. *Secur. Commun. Netw.* **2022**, *2022*, e5357412. [[CrossRef](#)]
50. Abdo, A.; Liu, H.; Zhang, H.; Guo, J.; Li, Q. A New Model of Faults Classification in Power Transformers Based on Data Optimization Method. *Electr. Power Syst. Res.* **2021**, *200*, 107446. [[CrossRef](#)]
51. Shamlou, A.; Reza Feyzi, M.; Behjat, V. Winding Deformation Classification in a Power Transformer Based on the Time-Frequency Image of Frequency Response Analysis Using Hilbert-Huang Transform and Evidence Theory. *Int. J. Electr. Power Energy Syst.* **2021**, *129*, 106854. [[CrossRef](#)]
52. Babnik, T.; Gubina, F. Two Approaches to Power Transformer Fault Classification Based on Protection Signals. *Int. J. Electr. Power Energy Syst.* **2002**, *24*, 459–468. [[CrossRef](#)]
53. Sudha, B.; Praveen, L.S.; Vadde, A. Classification of Faults in Distribution Transformer Using Machine Learning. *Mater. Today Proc.* **2022**, *58*, 616–622. [[CrossRef](#)]
54. Arias Velásquez, R.M. Support Vector Machine and Tree Models for Oil and Kraft Degradation in Power Transformers. *Eng. Fail. Anal.* **2021**, *127*, 105488. [[CrossRef](#)]
55. Fang, J.; Yang, F.; Tong, R.; Yu, Q.; Dai, X. Fault Diagnosis of Electric Transformers Based on Infrared Image Processing and Semi-Supervised Learning. *Glob. Energy Interconnect.* **2021**, *4*, 596–607. [[CrossRef](#)]
56. Rucconi, V.; Maria, L.D.; Garatti, S.; Bartalesi, D.; Valecillos, B.; Bittanti, S. Deep Learning For Fault Detection In Transformers Using Vibration Data. *IFAC-Pap.* **2021**, *54*, 262–267. [[CrossRef](#)]
57. de Lopes, S.M.A.; Flauzino, R.A.; Altafim, R.A.C. Incipient Fault Diagnosis in Power Transformers by Data-Driven Models with over-Sampled Dataset. *Electr. Power Syst. Res.* **2021**, *201*, 107519. [[CrossRef](#)]
58. Zeng, B.; Guo, J.; Zhang, F.; Zhu, W.; Xiao, Z.; Huang, S.; Fan, P. Prediction Model for Dissolved Gas Concentration in Transformer Oil Based on Modified Grey Wolf Optimizer and LSSVM with Grey Relational Analysis and Empirical Mode Decomposition. *Energies* **2020**, *13*, 422. [[CrossRef](#)]

59. Prasojo, R.A.; Gumilang, H.; Suwarno; Maulidevi, N.U.; Soedjarno, B.A. A Fuzzy Logic Model for Power Transformer Faults' Severity Determination Based on Gas Level, Gas Rate, and Dissolved Gas Analysis Interpretation. *Energies* **2020**, *13*, 1009. [[CrossRef](#)]
60. Zhang, W.; Yang, X.; Deng, Y.; Li, A. An Inspired Machine-Learning Algorithm with a Hybrid Whale Optimization for Power Transformer PHM. *Energies* **2020**, *13*, 3143. [[CrossRef](#)]
61. Kirkbas, A.; Demircali, A.; Koroglu, S.; Kizilkaya, A. Fault Diagnosis of Oil-Immersed Power Transformers Using Common Vector Approach. *Electr. Power Syst. Res.* **2020**, *184*, 106346. [[CrossRef](#)]
62. Malik, H.; Sharma, R.; Mishra, S. Fuzzy Reinforcement Learning Based Intelligent Classifier for Power Transformer Faults. *ISA Trans.* **2020**, *101*, 390–398. [[CrossRef](#)]
63. Arias Velásquez, R.M.; Mejía Lara, J.V. Root Cause Analysis Improved with Machine Learning for Failure Analysis in Power Transformers. *Eng. Fail. Anal.* **2020**, *115*, 104684. [[CrossRef](#)]
64. Almoallem, Y.D.; Taha, I.B.M.; Mosaad, M.I.; Nahma, L.; Abu-Siada, A. Application of Logistic Regression Algorithm in the Interpretation of Dissolved Gas Analysis for Power Transformers. *Electronics* **2021**, *10*, 1206. [[CrossRef](#)]
65. Aciu, A.-M.; Nicola, C.-I.; Nicola, M.; Nițu, M.-C. Complementary Analysis for DGA Based on Duval Methods and Furan Compounds Using Artificial Neural Networks. *Energies* **2021**, *14*, 588. [[CrossRef](#)]
66. Poonnoy, N.; Suwanasri, C.; Suwanasri, T. Fuzzy Logic Approach to Dissolved Gas Analysis for Power Transformer Failure Index and Fault Identification. *Energies* **2020**, *14*, 36. [[CrossRef](#)]
67. Wu, Z.; Zhou, M.; Lin, Z.; Chen, X.; Huang, Y. Improved Genetic Algorithm and XGBoost Classifier for Power Transformer Fault Diagnosis. *Front. Energy Res.* **2021**, *9*, 745744. [[CrossRef](#)]
68. Mao, W.; Wei, B.; Xu, X.; Chen, L.; Wu, T.; Peng, Z.; Ren, C. Fault Diagnosis for Power Transformers through Semi-Supervised Transfer Learning. *Sensors* **2022**, *22*, 4470. [[CrossRef](#)] [[PubMed](#)]
69. Zhou, Y.; Yang, X.; Tao, L.; Yang, L. Transformer Fault Diagnosis Model Based on Improved Gray Wolf Optimizer and Probabilistic Neural Network. *Energies* **2021**, *14*, 3029. [[CrossRef](#)]
70. Elbazi, N.; Mabrouki, M.; Chebak, A.; Hammouch, F. Digital Twin Architecture for Mining Industry: Case Study of a Stacker Machine in an Experimental Open-Pit Mine. In Proceedings of the 2022 4th Global Power, Energy and Communication Conference (GPECOM), Cappadocia, Turkey, 14–17 June 2022; pp. 232–237.
71. Ouahabi, N.; Chebak, A.; Zegrari, M.; Kamach, O.; Berquedich, M. A Distributed Digital Twin Architecture for Shop Floor Monitoring Based on Edge-Cloud Collaboration. In Proceedings of the 2021 Third International Conference on Transportation and Smart Technologies (TST), Tangier, Morocco, 27–18 May 2021; pp. 72–78.
72. Maghraoui, A.E.; Hammouch, F.-E.; Ledmaoui, Y.; Chebak, A. Smart Energy Management System: A Comparative Study of Energy Consumption Prediction Algorithms for a Hotel Building. In Proceedings of the 2022 4th Global Power, Energy and Communication Conference (GPECOM), Cappadocia, Turkey, 14–17 June 2022; pp. 529–534.
73. Harrold, D.J.B.; Cao, J.; Fan, Z. Renewable Energy Integration and Microgrid Energy Trading Using Multi-Agent Deep Reinforcement Learning. *Appl. Energy* **2022**, *318*, 119151. [[CrossRef](#)]
74. Homod, R.Z.; Togun, H.; Kadhim Hussein, A.; Noraldeen Al-Mousawi, F.; Yaseen, Z.M.; Al-Kouz, W.; Abd, H.J.; Alawi, O.A.; Goodarzi, M.; Hussein, O.A. Dynamics Analysis of a Novel Hybrid Deep Clustering for Unsupervised Learning by Reinforcement of Multi-Agent to Energy Saving in Intelligent Buildings. *Appl. Energy* **2022**, *313*, 118863. [[CrossRef](#)]
75. Padmanaban, S.; Khalili, M.; Nasab, M.A.; Zand, M.; Shamim, A.G.; Khan, B. Determination of Power Transformers Health Index Using Parameters Affecting the Transformer's Life. *IETE J. Res.* **2022**, 1–22. [[CrossRef](#)]
76. Zukowski, P.; Kierczynski, K.; Koltunowicz, T.N.; Rogalski, P.; Subocz, J.; Koreniak, D. AC Conductivity Measurements of Liquid-Solid Insulation of Power Transformers with High Water Content. *Measurement* **2020**, *165*, 108194. [[CrossRef](#)]
77. de Faria, H.; Costa, J.G.S.; Olivias, J.L.M. A Review of Monitoring Methods for Predictive Maintenance of Electric Power Transformers Based on Dissolved Gas Analysis. *Renew. Sustain. Energy Rev.* **2015**, *46*, 201–209. [[CrossRef](#)]
78. Batista, N.C.; Melício, R.; Mendes, V.M.F. Layered Smart Grid Architecture Approach and Field Tests by ZigBee Technology. *Energy Convers. Manag.* **2014**, *88*, 49–59. [[CrossRef](#)]
79. Hua, Z.; Zheng, Z.; Pahon, E.; Péra, M.-C.; Gao, F. Remaining Useful Life Prediction of PEMFC Systems under Dynamic Operating Conditions. *Energy Convers. Manag.* **2021**, *231*, 113825. [[CrossRef](#)]
80. Karavas, C.-S.; Kyriakarakos, G.; Arvanitis, K.G.; Papadakis, G. A Multi-Agent Decentralized Energy Management System Based on Distributed Intelligence for the Design and Control of Autonomous Polygeneration Microgrids. *Energy Convers. Manag.* **2015**, *103*, 166–179. [[CrossRef](#)]
81. Rahman, M.S.; Oo, A.M.T. Distributed Multi-Agent Based Coordinated Power Management and Control Strategy for Microgrids with Distributed Energy Resources. *Energy Convers. Manag.* **2017**, *139*, 20–32. [[CrossRef](#)]