



Article

# Design and Analysis of a Solar-Powered Electric Vehicle Charging Station for Indian Cities

Aanya Singh<sup>1</sup>, Shubham Sanjay Shaha<sup>1</sup>, Nikhil P G<sup>2</sup>, Yendaluru Raja Sekhar<sup>3</sup> , Shaik Saboor<sup>1</sup>   
and Aritra Ghosh<sup>4,\*</sup>

<sup>1</sup> Department of Thermal and Energy Engineering, School of Mechanical Engineering, Vellore Institute of Technology, Vellore 632014, Tamil Nadu, India; aanya.engg@gmail.com (A.S.); shahshubhamsanjaysjpa@gmail.com (S.S.S.); saboor.nitk@gmail.com (S.S.)

<sup>2</sup> Solar Resource Division, National Institute of Solar Energy, Gurugram 122003, Haryana, India; nikhilpg@nise.res.in

<sup>3</sup> Centre for Disaster Mitigation and Management, Vellore Institute of Technology, Vellore 632014, Tamil Nadu, India; rajasekhar.y@vit.ac.in

<sup>4</sup> College of Engineering, Mathematics and Physical Sciences, Renewable Energy, University of Exeter, Penryn, Cornwall TR10 9FE, UK

\* Correspondence: a.ghosh@exeter.ac.uk

**Abstract:** Due to depleting fossil fuel reserves coupled with a climate crisis, sustainability is gaining ground, and electric vehicles (EVs) are emerging to be the new face of this field. However, the idea of EVs will be genuinely sustainable only if they are charged using renewable energy. This paper presents results from the design of a solar-powered EV charging station for an Indian context. PVsyst 7.2 software has been used for the system design. The analysis, based on the number of cars charged annually, the monthly variation in energy generation, the investment cost, and the decrease in carbon dioxide (CO<sub>2</sub>) emissions using different module technologies for six Indian cities, has been deliberated. The results indicate that an off-grid 8.1 kWp system with two days of battery autonomy has the fewest unused energy losses, with a good performance ratio (PR). It can completely charge around 414 vehicles of 30 kWh battery capacity annually. This would help to reduce annual CO<sub>2</sub> emissions by approximately 7950 kg. For cities near the equator, maximum energy is produced during March or January, and for cities near the Tropic of Cancer, energy production maximizes during May–June. The overall system has better energy generation and economy when monocrystalline modules are used.

**Keywords:** solar photovoltaics; electric vehicles; charging stations; monocrystalline; polycrystalline



**Citation:** Singh, A.; Shaha, S.S.; G, N.P.; Sekhar, Y.R.; Saboor, S.; Ghosh, A. Design and Analysis of a Solar-Powered Electric Vehicle Charging Station for Indian Cities. *World Electr. Veh. J.* **2021**, *12*, 132. <https://doi.org/10.3390/wevj12030132>

Academic Editor: Joeri Van Mierlo

Received: 12 July 2021

Accepted: 22 August 2021

Published: 25 August 2021

**Publisher's Note:** MDPI stays neutral with regard to jurisdictional claims in published maps and institutional affiliations.



**Copyright:** © 2021 by the authors. Licensee MDPI, Basel, Switzerland. This article is an open access article distributed under the terms and conditions of the Creative Commons Attribution (CC BY) license (<https://creativecommons.org/licenses/by/4.0/>).

## 1. Introduction

Road transport is undoubtedly the most common and affordable form of commute for people around the world. However, recently, it has faced much criticism due to its dependence on fossil fuels and its relatively low operational inefficiency [1]. This has opened the doors for the electric mobility industry, and the world has witnessed a drastic surge in the acceptability of EVs.

As India aims to decrease its carbon footprint like other nations and step into the world of sustainability, the government is consistently introducing transport sector reforms that aim at the electrification of all effective forms of commute. As a result, according to a study conducted between 2020–2027, the average annual growth rate for the EV sector in India is estimated to be around 44% [2].

Articles published by various research scholars and authorities mainly focus on the importance of shifting towards EVs, the technical aspects of charging stations, and the governments' policies to develop the necessary infrastructure for EVs [3–5]. Topics such as the need for India to move away from its crude oil imports, fighting climate change to

reduce its carbon footprints, and reducing pollution have been discussed in detail, and conclusions regarding India moving into the EV space following its global peers have been made [6]. Moreover, new energy storage and transfer technologies that can be used to implement the charging infrastructure have been studied according to the necessary requirements [7–9].

It is essential to differentiate between what ‘looks sustainable’ and what ‘is sustainable’ to implement sustainability. EVs are a formidable example of decreasing instantaneous emissions, but they shift the energy demand from crude oil to electricity. This ultimately increases the pressure on the grid infrastructure that is already facing an energy deficit [3]. In India, nearly 61% of the grid electricity is from coal-based thermal power plants, 15% is from hydropower, 8% is from solar PV, 5% is from wind energy, 9% is from natural gas, and 2% is from nuclear energy [10].

Upon considering three categories of vehicles, EVs running on electricity from the grid, internal combustion engine-based vehicles (ICEVs), and EVs running on electricity from solar photovoltaics (PV), and calculating their well-to-wheel CO<sub>2</sub> emissions, EVs running on electricity from solar PV turned out to be the least polluting. Such an EV would lead to only 0.6 kg of CO<sub>2</sub> emission per 100 km travelled. In contrast, a 5-seater gasoline-based ICEV would produce about 13 kg of CO<sub>2</sub> in covering the same distance, and an EV running on grid electricity would cause 10 kg of CO<sub>2</sub> emissions per 100 km travelled (considering a similar share of the different sources, as listed above). The unavailability of charging stations at regular intervals is another matter of concern, and nearly all of the available ones are grid-tied. Hence, grid availability becomes a crucial point while deciding the location of a charging station.

India is a sun-drenched country, which makes it ideal for the utilization of solar energy for electricity production. When most of our energy requirements revolve around electricity, solar PV has proven to be an excellent solution for localized electricity generation, even for large-scale applications. Although renewables such as solar are climate dependent and the Indian climate varies with geography, the flexibility of solar PV as stand-alone systems with battery backup makes them quintessential for remote cities. Moreover, integrating solar PV with charging stations can help us achieve power autonomy, generate electricity more responsibly, and spare the land and marine ecosystem from the mining of coal and crude oil [11].

Utilizing solar energy for charging electric vehicles is an evolving idea and has taken ground over the past few years [12]. However, EVs have been in the market since the 1990s, and the literature related to charging station designs indicates the concern for grid availability while designing and siting charging stations [5,7,13,14]. Over the past ten years, researchers have tried to include solar energy for charging stations to ensure energy autonomy and reduced emissions. Countries like the Netherlands, Macau, and Romania are opting for solar energy to charge their EVs [15–17]. This has led to the development of smart and efficient hybrid PV systems for charging stations that can predict the load requirement and the energy generation [7,18,19]. However, most of them are for charging two-wheelers, which have a smaller battery bank than four-wheeler EVs [7,18–21]. Moreover, these plans and designs are suited to urban commercial buildings [7,12].

In the context of the previous literature reported, it is evident that there is a considerable gap in designing the aspects of a solar-powered EV charging station. Feasibility analysis has been done on the Indian market for EVs, and it proves the viability of a renewable-based charging station for the country [22]. This paper aims to fulfill those gaps and thus specifically focus on the following objectives:

- To size an efficient, resilient, and sustainable off-grid solar PV system suitable for EV charging stations in India.
- To analyze & compare its yearly and seasonal performance for six Indian cities. The operational parameters include the number of cars charged, the monthly variation in energy generation, PR, the decrease in CO<sub>2</sub> emissions, and the investment cost per km.

The novel part of the study includes an attempt to optimize the size of the PV array capacity based on the PR and the percentage of unused energy.

## 2. Method

System sizing starts with identifying the standards and regulations for EV charging stations. This is followed by the selection of cities for which simulation will be performed. Solar energy is directly related to the location's climatology; hence, comprehension and analyses of weather patterns become imperative. Next, a daily load for the charging station is decided, after which suitable system components are chosen and manual calculations are done to size the battery bank and the solar array capacity. Then, using simulation, the system performance is analyzed, and the array capacity is altered to minimize unwanted losses. Further simulations are performed on the new array capacity, and modifications are done if required. This is an iterative process, and amendments are made to attain the most optimized version of the solar PV system. Finally, the performance data, thus calculated, are recorded and compared for different locations. Figure 1 represents the system sizing methodology as a schematic.

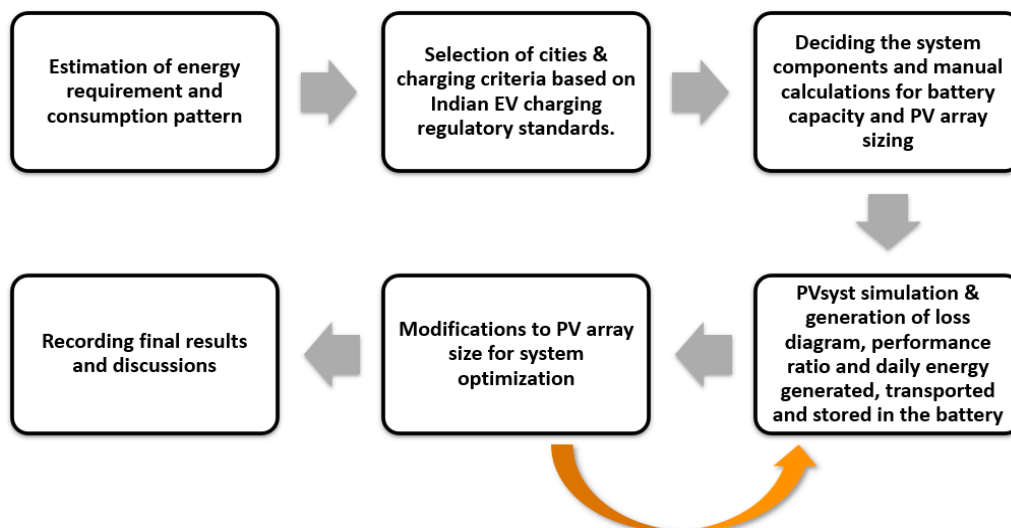

Figure 1. Methodology for PV system design.

### 2.1. Standards

EV charging has been regulated by various institutions such as AIS, SAE, and IEC. The charging level modes and specifications of the connectors have been clearly mentioned in the guidelines issued by these organizations. Tables 1 and 2 summarize the different standards for charging EVs.

Table 1. EV charging levels [22–24].

Charging Type	Level 1	Level 2	Direct Current (DC) Fast
Charging time (h)	20 to 22	6 to 8	0.2 to 0.5
Charger location	On-board (1 phase)	On-board (1 or 3 phase)	Off-board (3 phase)
Voltage supply (V)	120	240	208 to 600
Power level (kW)	1.3 to 1.9	up to 19.2	50 to 150
Travel range	2–5 miles/h of charging	10–20 miles/h of charging	60–80 miles in <30 min
Primary Use	Residential charging	Residential and public charging	Public charging

Table 2. EV charger specifications [11,21,24].

Charger Type	Charger Connector	Rated Output Voltage (V)	No. of Connector Guns	Charging Vehicle Type (W-Wheeler)
Fast	Combined charging system (CCS) (Min 50 kW)	200–750 or higher	1	4W
	Charge de move (CHAdeMO) (Min 50 kW)	200–500 or higher	1	4W
	Type-2 alternating current (AC) (Min 22 kW)	380–415	1	4W, 3W, 2W
Slow/moderate	BHARAT DC-001 (15 kW)	48	1	4W, 3W, 2W
	BHARAT DC-001 (15 kW)	72 or higher	1	4W
	BHARAT AC-001 (10 kW)	230	3 of 3.3 kW each	4W, 3W, 2W

2.2. Selection of Cities and Climate Analysis

India is located in the northern hemisphere, with the Tropic of Cancer (23.5° N) passing through it. According to the National Building Code (NBC), India is majorly divided into five major climatic zones: cold, composite, hot & dry, warm & humid, and temperate [25]. For this analysis, six Indian cities have been selected, each featuring a different region and belonging to one of these climatic zones. The coordinates and altitudes for each of these cities are given in Figure 2.

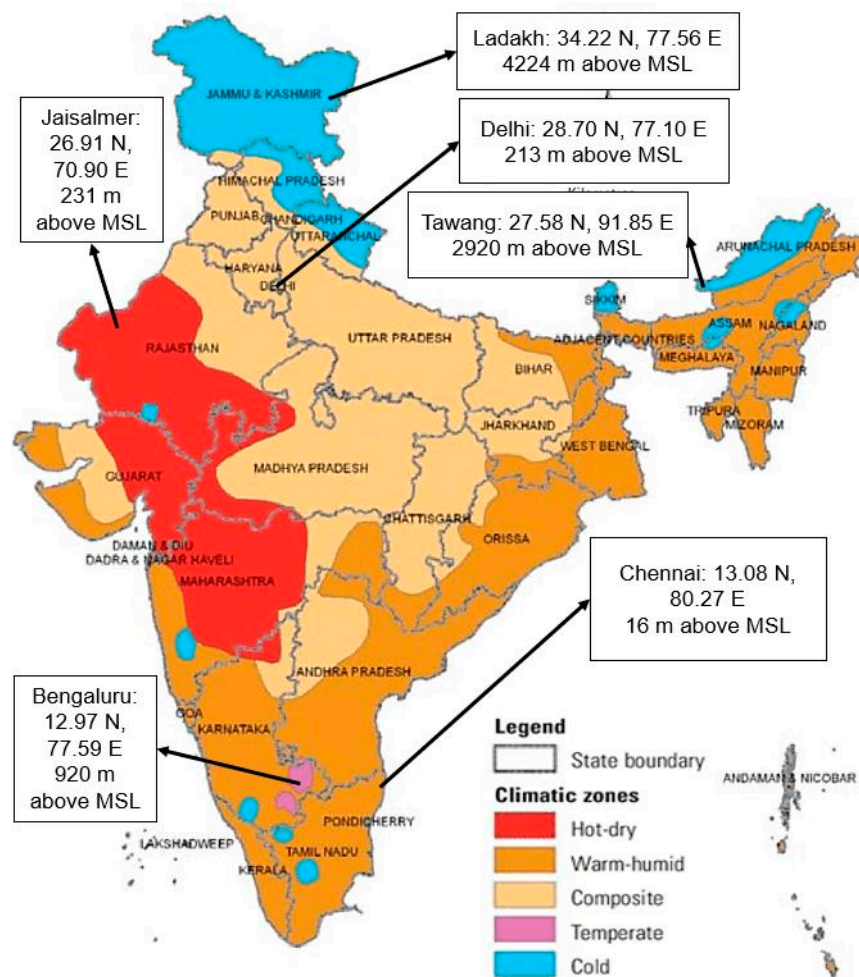

Figure 2. Selected cities for the analysis [25–27].

All these cities experience different weather conditions throughout the year. This mainly depends on the latitude and altitude of a place and its distance from the sea. The significant parameters that indicate a location's weather condition, pertinent to solar PV, are maximum & minimum ambient temperatures, cloud cover, total day length, number of actual sunshine hours, atmospheric turbidity, global radiation, and the number of 'full Sun hours.' These factors vary for each city throughout the year, depending on the city's geography and population. Some of these critical parameters have been tabulated for these six cities in Table 3.

**Table 3.** Weather parameters of the selected cities [26,27].

City	Maximum Ambient Temperature (°C)	Minimum Ambient Temperature (°C)	Month with Maximum. Global Radiation (kWh/m <sup>2</sup> )	Month with Maximum Linke Turbidity Factor	Annual Average Number of Full Sun Hours (kWh/kWp)
Ladakh	15	−14	June: 215	April: 2.751	5.2
Delhi	44	5	May: 220	April–August, October–November: 7.0	4.0
Tawang	24	−3	June: 170	April: 4.59	3.6
Jaisalmer	43	8	May: 220	April–August: 7	4.6
Chennai	40	20	March: 197	May: 6.594	4.4
Bengaluru	37	13	March: 210	May: 5.395	4.2

Day length is the time between sunrise and sunset, whereas the 'actual number of sunshine hours' refers to the effective day length without cloud cover. Linke turbidity is a factor assigned for the level of suspended particles in the atmosphere. This can be smoke, dust, fog, or small water droplets. The higher the concentration of suspended particles, the higher the turbidity factor. Due to variations in the instantaneous ambient temperature, global irradiation, cloudiness levels, and turbidity values, a fixed parameter known as 'average full sun hours' has been computed for every city. This represents the annual average of the number of units of energy produced by a 1 kWp installation per day if it is tilted at the latitude angle. This parameter is essential for initial system sizing; however, it does not mention instantaneous energy generation.

### 2.3. PV Sizing

Any PV system sizing can be divided into two stages: preliminary calculations and system optimization. Usually, the client provides an initial value for any specific parameter, which becomes the base for all preliminary measures and further optimization. This boundary condition can vary from a budget limit to a spatial limit depending on the situation. Since this work does not predicate any such restrictions, the preliminary system sizing is initiated with the selection of the type of system. Here, off-grid PV system is chosen for the charging station. The load requirement is fixed and the load profile per day is determined. The entire battery bank and array have to be designed to sustain peak load demands for off-grid systems, resulting in extensive systems with high costs. Hence, for the charging station, the consumption profile is assumed to be constant throughout the day at 2.5 kW per hour, equivalent to a load of 60 kWh per day. Figure 3 shows the working of the off-grid PV system.

The PV array generates energy from morning to evening during the sun hours. After fulfilling the load, the remaining energy is fed to the battery. The charge controller ensures that the instantaneous energy generation does not exceed the energy requirement of the consumer and the battery capacity available. The energy is supplied to the EVs from night to the early morning hours by the battery bank.

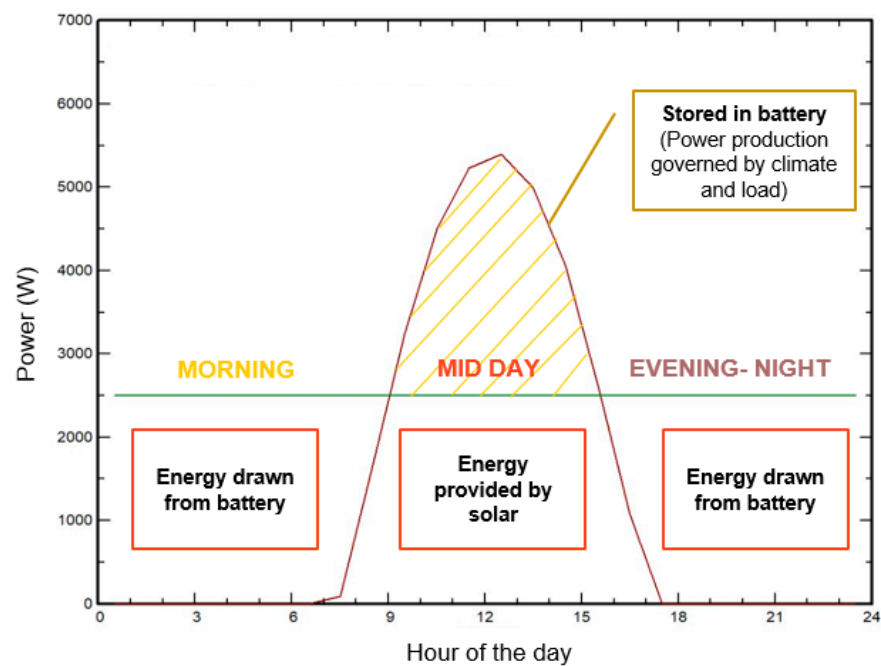

Figure 3. Generation vs. requirement profile of the charging station for a day.

The selection of the station structure is another important criterion that depends on the solar PV application. A carport structure is preferred for the concerned design since this integrates the parking area with the array installation area. The array also acts as the roof for the parking zone and the battery room. Since most carport structure manufacturers allow only a 5–10° tilt, a south-facing roof with a 10° tilt is opted for the charging station. The azimuth angle of the solar array is entirely subject to the available space. Figure 4 shows a carport integrated charging station.

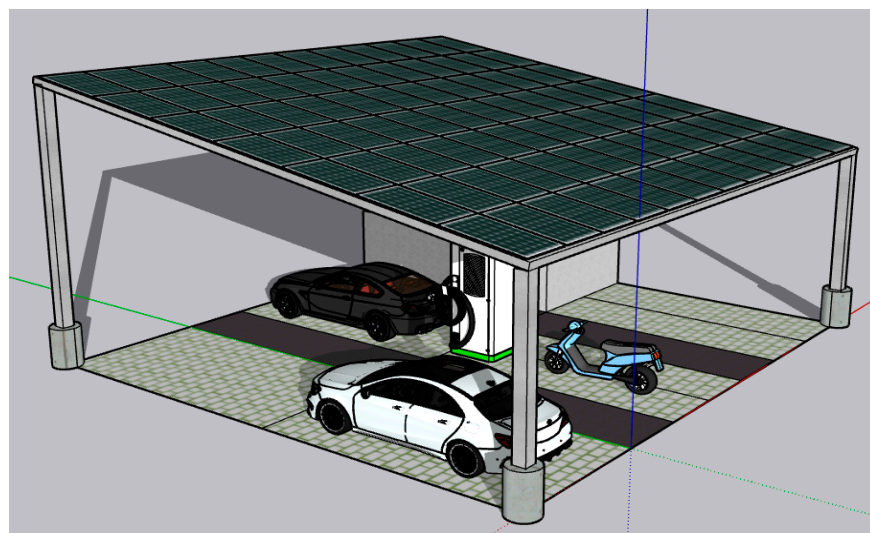
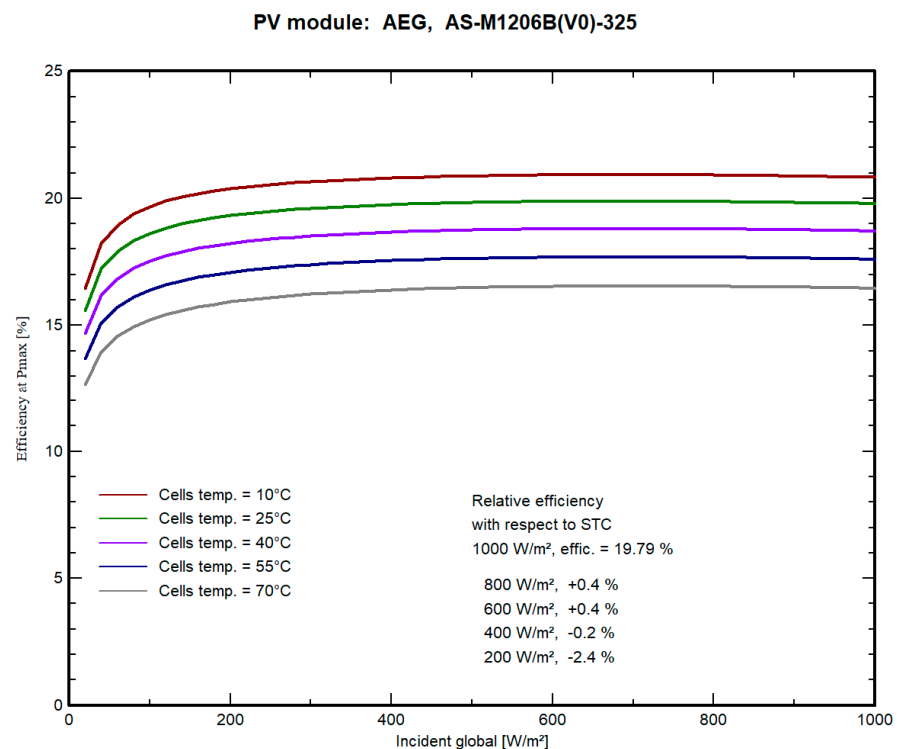

Figure 4. Schematic representation of carport charging infrastructure.

The determination of the charging criteria is crucial, as it directly affects the system sizing and economics. Therefore, the system voltages and the charging conditions are governed by the codes and standards mentioned in Section 2.1. Here, the station design has been carried out according to Level-2 charging with a BHARAT DC-001 15 kW (240 V) GB/T connector. Following this, the major components of the charging station are selected, such as the PV array, battery bank, charge controller, EV charger, cabling, accessories,

fasteners, and carport structure. The PV module, charge controller, and battery are the key elements of any off-grid solar PV plant.

In this case, the aim is to compare two module technologies that would only be feasible if the modules are manufactured by the same company and have the same rated power. Modules with higher power ratings cost more but are required in less quantity. Minimizing the station area is also necessary for system optimization; hence, a higher power rating module has been selected. Two modules from 'AEG Solar' (a monocrystalline and a polycrystalline) of 325 Wp and 72 cells are selected (Figure 5) and compared for this design. The 325 Wp modules have been chosen since this was the highest common rated power in the PVsyst database for two different module technologies from the same manufacturer. Monocrystalline technology is more efficient and more expensive, while polycrystalline technology is less efficient and cheaper. The modules' responses to variations in temperature and irradiation differ, since the actual conditions are not similar to the 'Standard Testing Conditions (STC)'. Therefore, the polycrystalline module has been used for the initial array optimization part. The system performance data have been generated with both the modules and are mentioned in Section 3. Figures 5 and 6 show the efficiency curves for the monocrystalline and polycrystalline modules, respectively.



**Figure 5.** Efficiency curve for the selected monocrystalline module.

As far as the battery is regarded, two main technologies are available commercially: lead-acid and lithium-ion. Out of these two, lithium-ion is relatively new for large-scale applications. On the other hand, lead-acid has been used for several years for energy storage, specifically in large-scale applications, and is cheaper than lithium-ion by a considerable margin. However, there are some advantages of lithium-ion over lead-acid batteries. For example, they have a higher depth of discharge (DoD), lower maintenance issues, a longer life, inbuilt safety switches for each battery, a lower C-rating, no exposed wires, no toxic fumes, and compact. On the other hand, Lead-acid batteries release toxic fumes, require large ample space, have no safety switches, have a lower DoD, have a shorter life, have a higher C-rating, have exposed wires, and have frequent maintenance issues. Hence, lithium-ion batteries have been selected here for the charging station design. The specifications for the battery are given in Table 4.

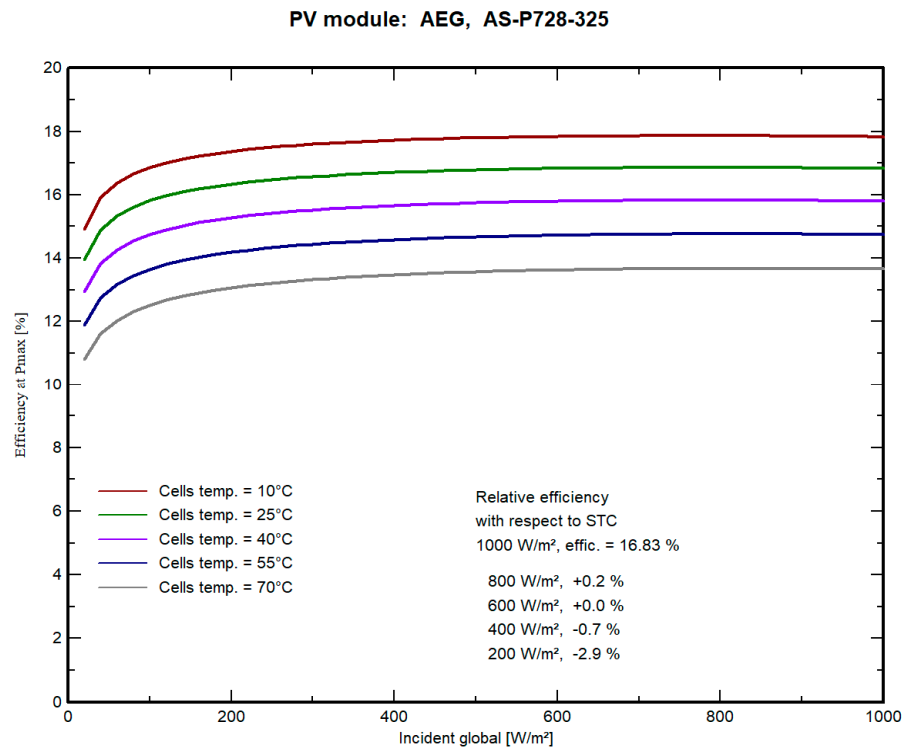

**Figure 6.** Efficiency curve for the selected polycrystalline module.

**Table 4.** Specifications of the battery considered for the analysis [source- PVsyst 7.2 database].

Battery Parameters	
Technology	Lithium ion
Nominal Voltage (V)	25.6
Capacity at C10 in Ampere hour (Ah)	180
DoD	95%
Life at 95% DoD (years)	5

The technical specifications of the module and battery are utilized for the preliminary manual calculations. These calculations give an initial set of values for the nameplate battery capacity, battery series, parallel configuration, and array capacity. These preliminary calculations are performed using the following set of equations.

$$b_{req} = \frac{[U_{day} \times Days\ of\ autonomy \times 1000]}{[DoD \times V_{system}]} \quad (1)$$

$$B_{req} = \frac{[b_{req} \times V_{system}]}{1000} \quad (2)$$

$$c_1\ battery = \frac{[C_1\ battery \times 1000]}{V_{nominal}} \quad (3)$$

$$Total\ number\ of\ batteries\ required = \frac{[B_{req} \times 1000]}{[V_{nominal} \times c_1\ battery]} \quad (4)$$

$$B_{series} = \frac{V_{system}}{V_{nominal}} \quad (5)$$

$$B_{parallel} = \frac{Total\ number\ of\ batteries\ required}{B_{series}} \quad (6)$$



$$b_{given} = c_{1 \text{ battery}} \times B_{parallel} \quad (7)$$

$$B_{given} = \frac{[V_{nominal} \times B_{series} \times b_{given}]}{1000} \quad (8)$$

$$S_{req} = \frac{B_{req}}{\text{Estimated charge controller efficiency}} \quad (9)$$

$$A_{req} = \frac{S_{req}}{h} \quad (10)$$

$$A'_{req} = A_{req} \times 1.2 \quad (11)$$

$$Area_{inst} = A'_{req} \times \text{Number of panels per kW installation} \times \text{Area of 1 panel in m}^2 \quad (12)$$

where,

$b_{req}$ : Required battery bank capacity in Ah

$U_{day}$ : Usable battery storage required per day in kWh

$V_{system}$ : System voltage in V

$B_{req}$ : Required battery bank capacity in kWh

$c_{1 \text{ battery}}$ : Capacity of 1 battery in Ah

$C_{1 \text{ battery}}$ : Capacity of 1 battery in kWh

$V_{nominal}$ : Nominal voltage of 1 battery in V

$B_{series}$ : Number of batteries in series

$B_{parallel}$ : Number of parallel strings of the batteries

$b_{given}$ : Provided battery capacity in Ah

$B_{given}$ : Provided battery capacity in kWh

$S_{req}$ : Required solar array capacity in kWh

$h$ : Average number of full sun hours per day

$A_{req}$ : Required solar array capacity in kW

$A'_{req}$ : Required solar array capacity after DC oversizing in kW

$Area_{inst}$ : Area required for installation in  $m^2$

The system voltage is fixed at 240 V, with two days of autonomy to balance resilience and the system size. The higher the autonomy, the higher the resilience, array, and battery size. The required battery capacity is the minimum nameplate battery capacity needed to sustain the load with two days of autonomy. This is computed to be around 526.32 Ah/126.32 kWh. The given battery capacity denotes the battery capacity closest to the required battery capacity that is possible with the chosen battery model. In this case, the given battery capacity is 540 Ah/129.6 kWh in 10 series X 3 parallel configuration. Maximum power point tracking (MPPT) technology is preferred for the charge controller since it has better efficiency and allows for a higher solar array voltage. For the MPPT charge controller efficiency, a generic value of 98% is chosen. The charge controller rating depends on the required array size, which is subject to alterations. The solar array necessary capacity obtained from these manual calculations is around 36 kWp. This would require an area of around 220  $m^2$ .

To check the performance of this system, PVsyst 7.2 is used. The results obtained from the preliminary calculation and other previous assumptions are used to create this off-grid PV plant on the software, and the simulation is carried out for an entire year. The simulation on PVsyst 7.2 includes nearly 50 variables, including the weather data, component details, and system losses. These variables are taken from Meteonorm and PVsyst's database. Using the 'One-diode' model, the array's hourly and monthly energy balance values are computed for an entire year. Here, the entire module is considered as a single diode instead of multiple cells connected together. Figure 7 shows the inputs given in PVsyst 7.2 for the simulation.

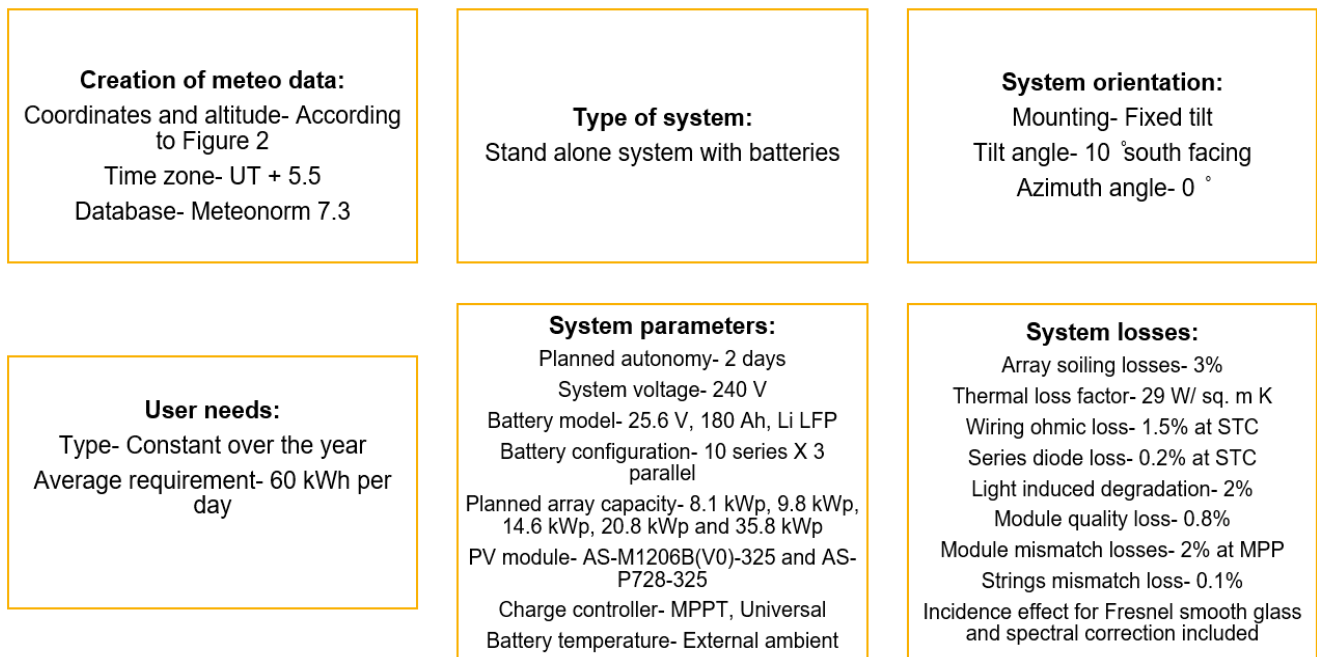

Figure 7. Simulation inputs for PVsyst 7.2 [28–30].

The results generated found that the PR was extremely low for the 35.8 kWp system in all six cities, and the percentage losses due to full batteries were high. The PR shows how much energy is practically supplied to the consumers compared to what the system would have generated if it had worked under ideal STC conditions. When the array’s energy production exceeds the combined load requirement of the station battery bank and the EV, the charge controller prevents the array from generating more energy. These losses are considered as unused energy losses. Unused energy is the difference between the plant’s actual energy generation and the plant’s energy generation potential under STC conditions. The array size is gradually decreased to optimize the system, simulations are done for all the iterations, and the PR and losses due to unused energy are recorded. The values obtained for all the cities have been mentioned in Figures 8 and 9.

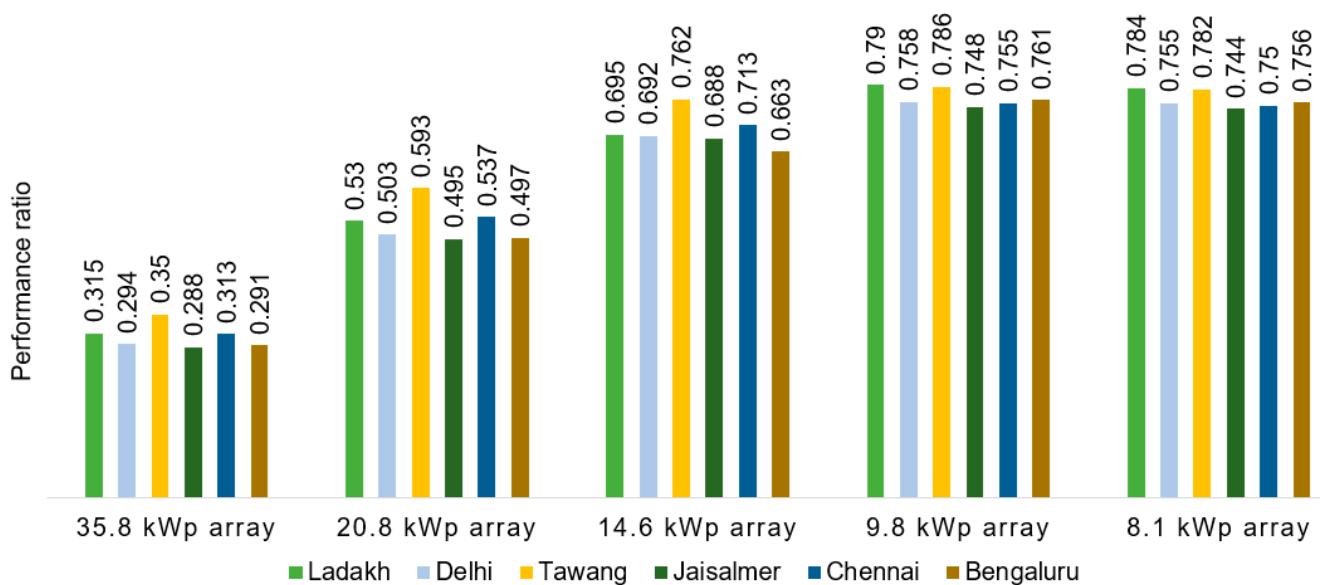

Figure 8. Performance ratio (PR) for different array sizes in all six cities.

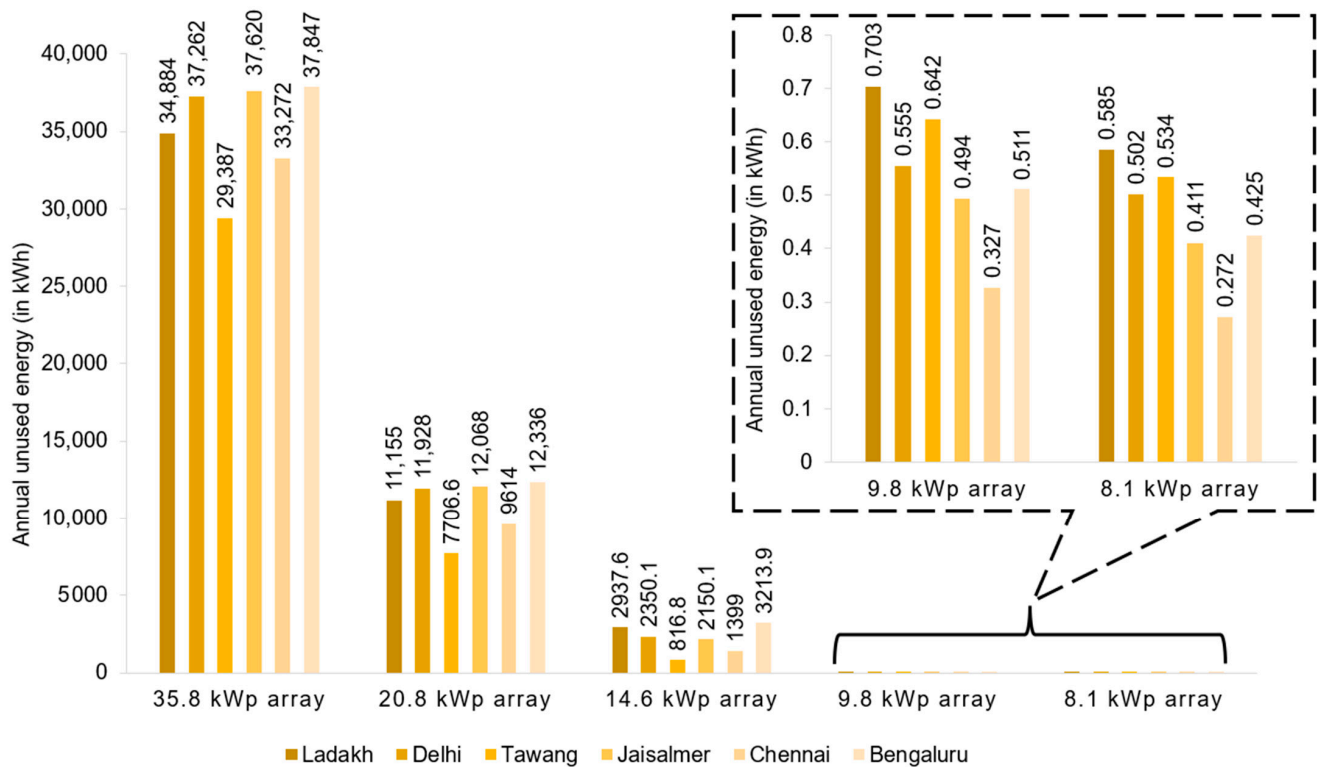

Figure 9. Annual unused energy for different array capacities in all six cities.

The highest PR for all cities is achieved with a 9.8 kWp array. For all cities, the losses due to unused energy are the least for the 8.1 kWp array, and the PR is also significantly high. Therefore, the 8.1 kWp array is selected for carrying out further analyses. The MPPT charge controller for this system is selected according to the new array size.

The final technical details of the proposed system are given in Table 5, and its electrical layout is shown in Figure 10.

Table 5. Technical specifications of the optimized 8.1 kWp system.

System Technical Specifications					
Station Structure		PV Array		Orientation	
Structure	Carport	Total capacity	8.1 kWp	Tilt	10 degrees
Area	80 m <sup>2</sup>	Module wattage	325 Wp	Azimuth	0 degrees for simulation (south facing)
Battery Bank		Charging Conditions		Load Profile	
Autonomy	2 days	Category	Level-2 DC charging	Daily load	60 kWh
Technology	Lithium ion	Charger	BHARAT DC-001	Hourly load	2.5 kW per hour
DoD	95%	System voltage	240 V DC	Profile	Constant
Life	5 years				
Capacity	540 Ah/129.6 kWh				

After the simulation of this system for all six cities, for both PV modules, the daily and monthly energy balance charts are generated for an entire year, which depict the relation between energy consumption, energy generation, stored energy, and energy supply. All these results have been tabulated and discussed in Section 3.

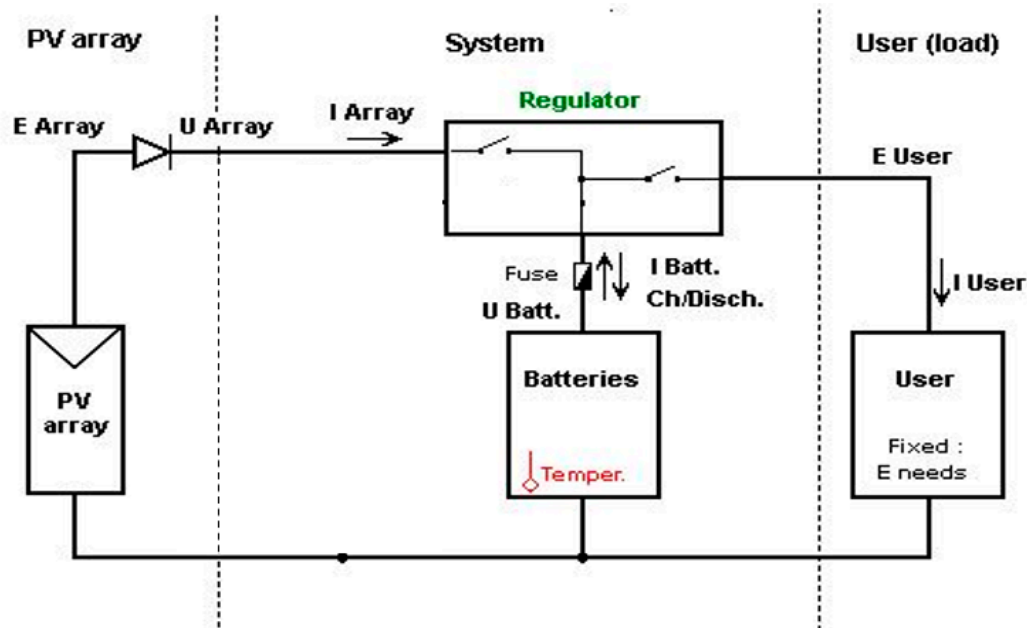

Figure 10. Single line diagram of the charging station.

### 3. Results

From the energy balance data generated using PVsyst, the monthly and annual energy supplied by the system to EVs can be tabulated. The energy generated and provided by the 8.1 kWp charging station in each city is different for each month and varies depending on the climatic factors present there. Figure 11 shows the PR comparison for the system using monocrystalline and polycrystalline modules.

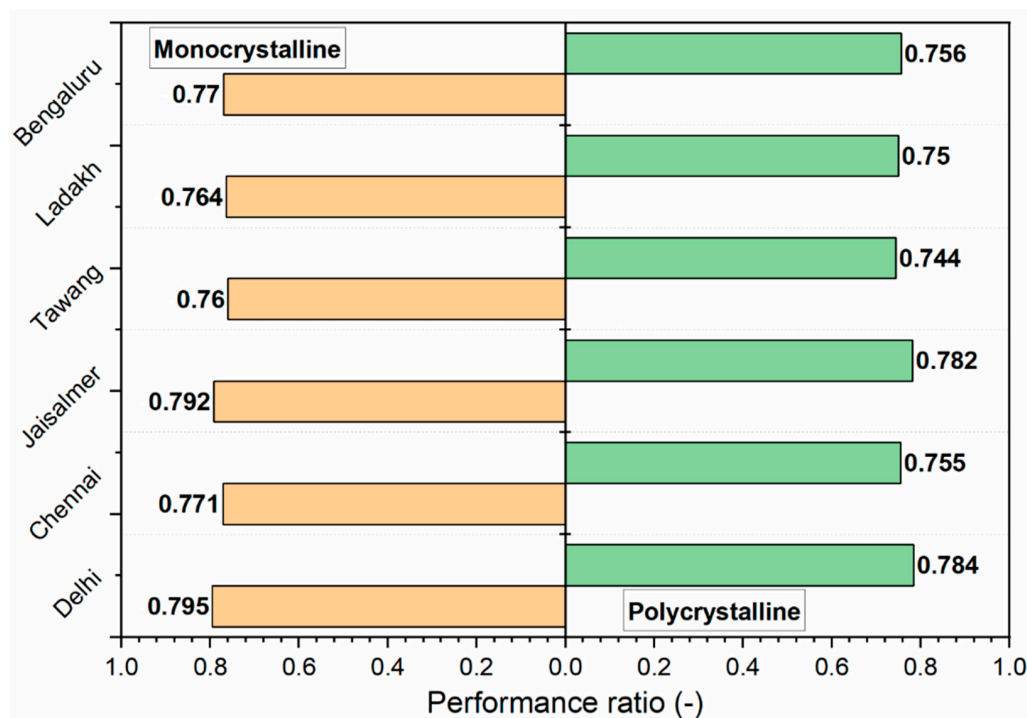

Figure 11. Performance ratio for the station in all six cities with different module technologies.

Figures 12 and 13 show the monthly variation in the energy supplied by the system in six different cities from monocrystalline and polycrystalline modules, respectively. Such a monthly analysis helps to create a charging schedule for the station.

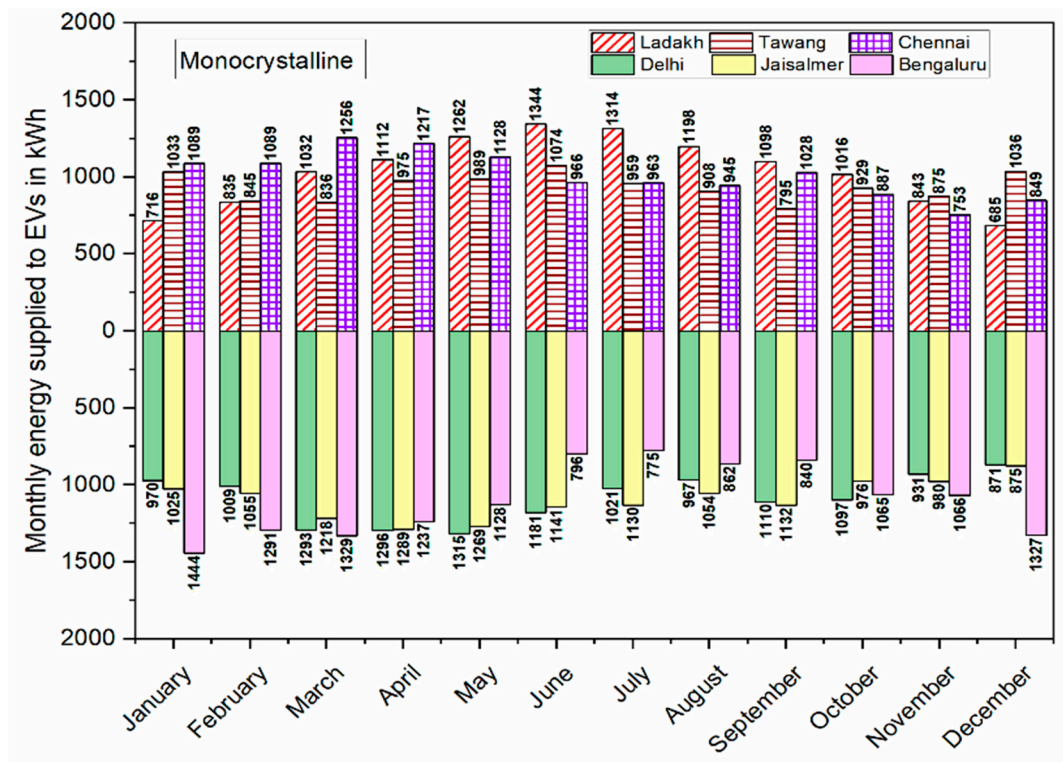

Figure 12. Monthly variation in energy supplied to EVs by the charging station using monocrystalline modules.

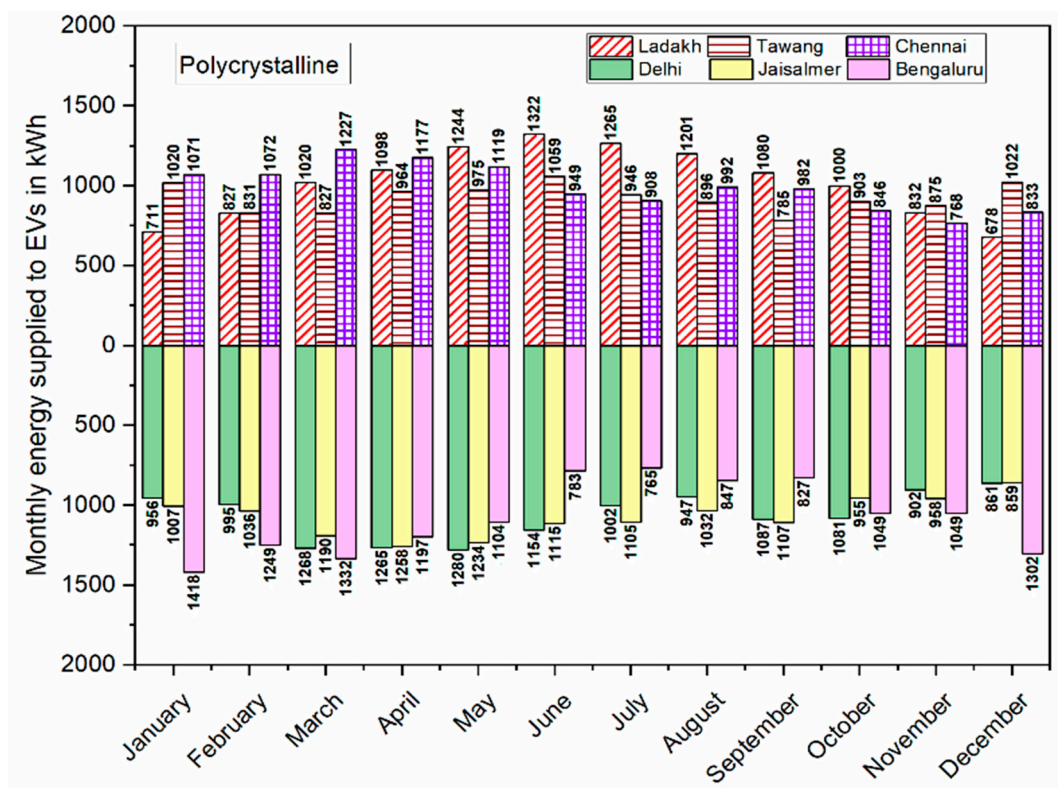

Figure 13. Monthly variation in energy supplied to EVs by the charging station using polycrystalline modules.

The number of EVs charged by the charging station depends on the vehicle’s battery capacity and the energy supplied to it by the charging station. Here, the number of EVs with 30 kWh battery capacity, which can be completely charged with each city’s charging station, has been calculated [31]. Figures 14 and 15 represent the annual energy supplied by the

charging station to EVs and the number of EVs completely charged using monocrystalline and polycrystalline modules, respectively.

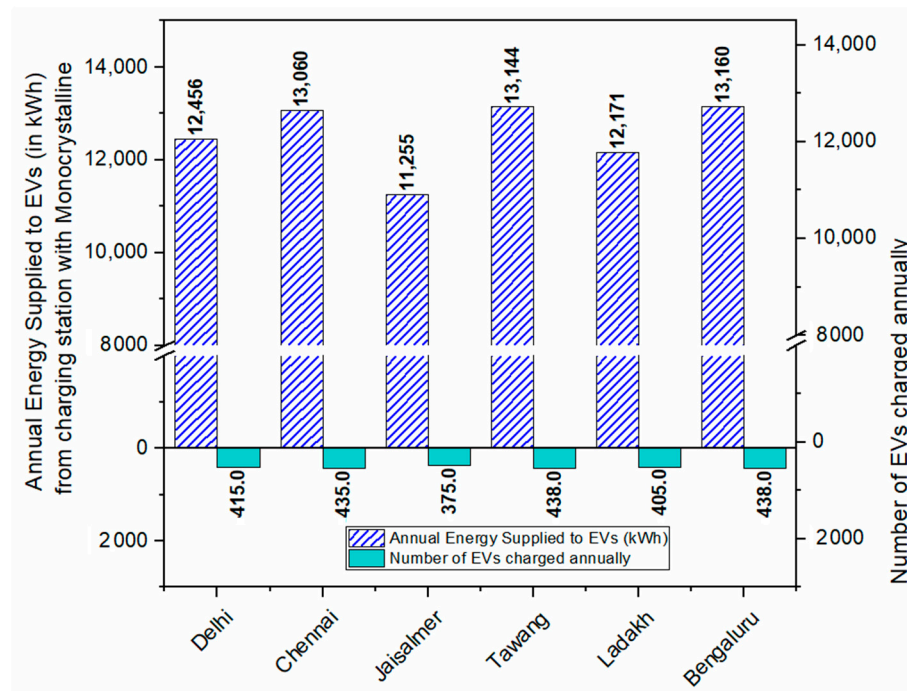

Figure 14. Annual energy supplied to EVs by the charging station using monocrystalline panels.

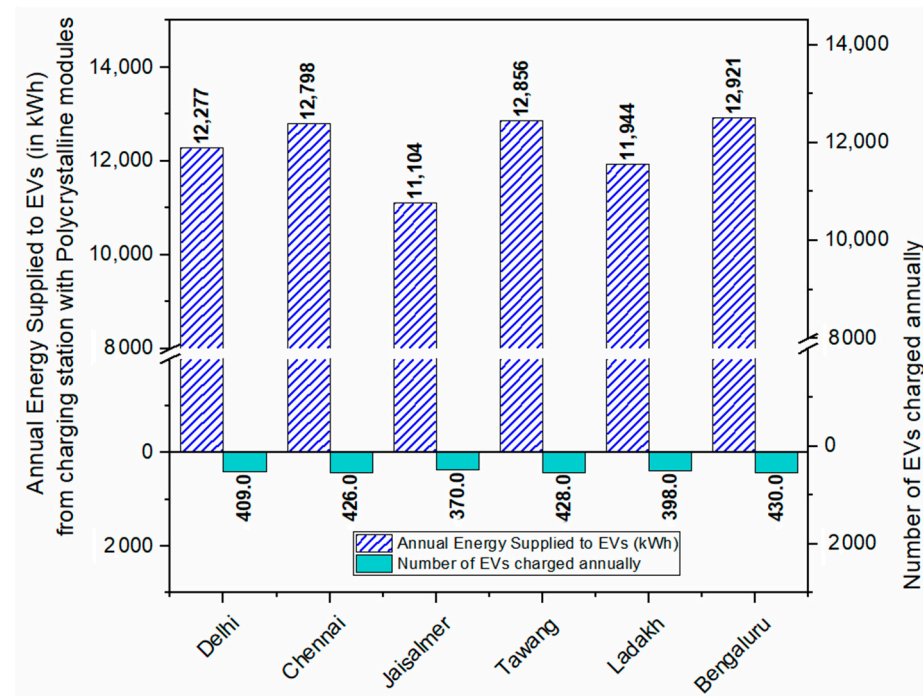
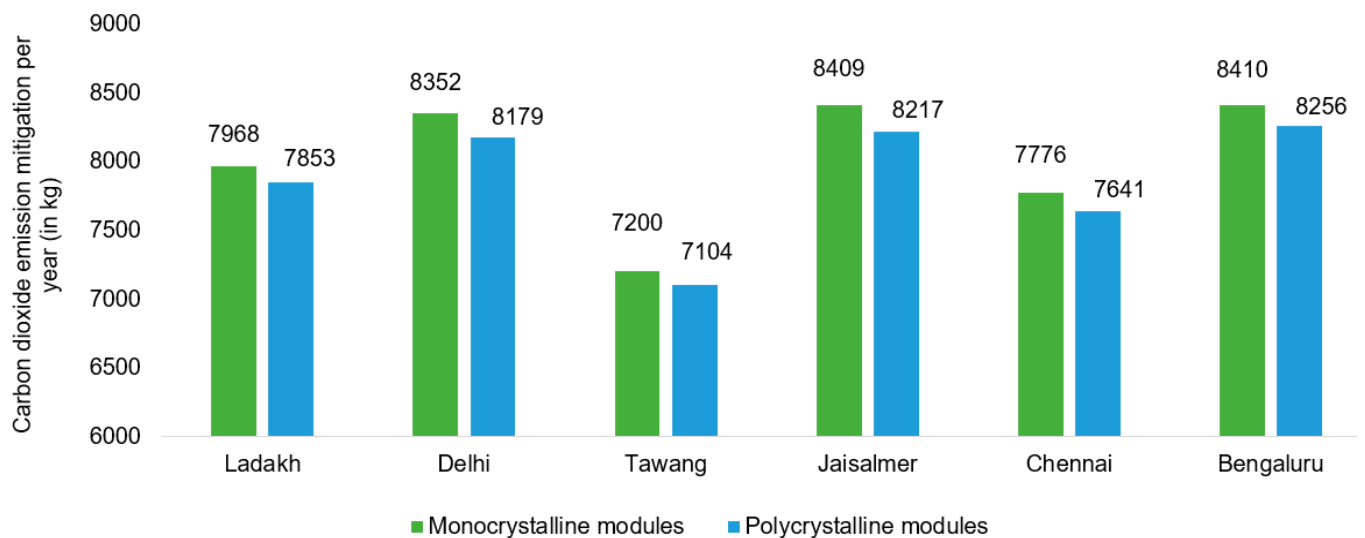

Figure 15. Annual energy supplied to EVs by the charging station using polycrystalline panels.

The decrease in emissions has been computed with respect to the amount of CO<sub>2</sub> that would have been emitted if the same amount of energy was taken from the grid (proportionate to the share of different energy generation sources contributing to the grid). Figure 16 shows the reduction in emissions by the system using monocrystalline and polycrystalline panels.



**Figure 16.** Reduction in CO<sub>2</sub> emissions by the charging station using monocrystalline and polycrystalline panels.

The cost of each component and the system's total cost were calculated over its lifetime (20 years) by considering component costs. This was converted to investment cost per kilometer for ease of comparison. Then, the total number of kilometers that can be covered by EVs using the energy supplied by the charging station in Tawang in 20 years was calculated for both the monocrystalline and polycrystalline systems. Out of all the cities chosen, Tawang has the least energy generation and supply; hence, it was used to analyze the worst-case scenario. The results have been tabulated in Table 6.

**Table 6.** Investment cost per km comparison.

System Type	Investment Cost over 20 Years (INR) (Assuming No Inflation & Depreciation)	Total Distance in 20 Years in km (Considering Tawang's Data)	Investment Cost Per Unit Distance (INR/km)
8.1 kWp (monocrystalline array)	6,022,050	1,485,660	4.05
8.1 kWp (polycrystalline array)	5,997,675	1,465,728	4.09
Gasoline stations	7,428,300 (Gasoline cost)	1,485,660	5 (can go up to 7 if station cost is included)

#### 4. Discussion

Table 7 represents the factors affecting the monthly energy output from the PV array for all of the six cities chosen. The monthly energy supplied by the system shown in Figures 11 and 12 for the six cities concurs with the climatic factors described in Table 7. Months with less atmospheric turbidity, sparse cloud cover, and longer days with high radiation increase the energy supply from the system.

Although the energy data is different for monocrystalline and polycrystalline panels, the system's trends in energy generation and supply to the EVs are similar. Out of the two modules, monocrystalline panels have higher energy generation due to their better efficiency; therefore, the system utilizing these has a higher energy supply, as can be seen in Figures 12 and 13.

Figures 14 and 15 indicate that the charging station in Bengaluru has the potential to charge maximum EVs since it supplies the maximum energy annually. Similarly, the charging station in Tawang supplies the least amount of energy annually, so it can charge the fewest number of EVs. From Figures 14–16, it can be inferred that the decrease in CO<sub>2</sub> emissions is directly proportional to the amount of energy supplied to the EVs. Therefore,

the charging station in Bengaluru mitigates the maximum CO<sub>2</sub> emissions, and the station in Tawang reduces the fewest CO<sub>2</sub> emissions.

**Table 7.** Factors affecting the monthly energy supplied by the system in all six cities.

City	November–January	February–April	May–June	July–October
Ladakh	Low ambient temperature Shorter days High atmospheric turbidity Sun path near horizon Dense cloud cover	Low solar radiation Less atmospheric turbidity Low ambient temperature Moderate-dense cloud cover	Low ambient temperature Less atmospheric turbidity High solar radiation Longer days Sun path near the zenith Sparse cloud cover	Low ambient temperature Less atmospheric turbidity Sparse cloud cover
Delhi	Low ambient temperature Low solar radiation High atmospheric turbidity Shorter days Sun path near horizon	Low atmospheric turbidity Higher solar radiation	High solar radiation High ambient temperature Longer days Sun path near the zenith	Decrease in ambient temperature Moderate-high atmospheric turbidity Dense cloud cover
Tawang	Low ambient temperature Low solar radiation Shorter days Sun path towards the horizon Sparse cloud cover	Increase in solar radiation Ambient temperature near STC limit Sparse cloud cover	High solar radiation Longer days Ambient temperature close to STC limit Sun path near the zenith Moderate cloud cover	Low solar radiation Ambient temperature close to STC limit Dense cloud cover
Jaisalmer	Low ambient temperature Shorter days Sun path near the horizon Sparse cloud cover	Less atmospheric turbidity High ambient temperature Sparse cloud cover	High solar radiation Less atmospheric turbidity High ambient temperature Longer days Sun path near the zenith Sparse cloud cover	Less-moderate atmospheric turbidity Slight decrease in ambient temperature Sparse-moderate cloud cover
Chennai	High atmospheric turbidity Ambient temperature slightly above STC limit Sun path in southern sky close to zenith Dense cloud cover Shorter days	Moderate-dense cloud cover High solar radiation High atmospheric turbidity	Dense cloud cover High solar radiation Sun path in the northern sky close to the zenith High ambient temperature	Dense cloud cover High atmospheric turbidity Moderate-high ambient temperature
Bengaluru	Moderate atmospheric turbidity Shorter days Partially cloudy sky Temperatures below the STC limit Sun path in the southern sky close to the zenith	High ambient temperatures Sun path vertical to the PV plane Dense cloud cover	Moderate ambient temperature Sun path in northern sky close to the zenith Longer days Dense cloud cover	Slight decrease in ambient temperature Sun path in southern sky close to the zenith Dense cloud cover

From Table 6, it is observed that the lower cost of polycrystalline panels coupled with the lesser energy generation leads to a higher investment cost per kilometer than monocrystalline modules. However, despite the high initial cost, the overall economy of solar-powered charging stations is better than gasoline stations, mainly due to the low maintenance cost and free fuel. For gasoline stations, the initial investment is low, but the cost of gasoline is high and is expected to rise even more in the future. Therefore, the investment cost is also high.

Figures 12 and 16 and Table 6 demonstrate that the higher energy generation and supply and the lower cost per km of the monocrystalline module chosen make it a better option than the polycrystalline module.



## 5. Conclusions and Future Scope of Work

- Out of all the array sizes selected, the 8.1 kWp solar PV system with two days of battery autonomy (129.6 kWh battery capacity) has the fewest unused energy losses and a good PR in all six of the cities: Delhi, Chennai, Jaisalmer, Tawang, Ladakh, and Bengaluru.
- An annual average of 12,428.8 kWh of energy can be generated from this system, which is sufficient to charge 414 vehicles with a battery capacity of 30 kWh. This would help in decreasing CO<sub>2</sub> emissions by around 7950 kg per year.
- For cities near the Tropic of Cancer, namely, Delhi, Tawang, Jaisalmer, and Ladakh, maximum energy is produced from May–July, and for cities near the Equator, namely, Bengaluru and Chennai, more energy is produced during November–January and February–April, respectively. Out of all of the cities, the maximum energy supplied in a month is 1444 kWh in Bengaluru in January, and the minimum is 685 kWh in Ladakh in December.
- According to the annual energy supplied by the charging station, the maximum number of cars can be charged in Bengaluru and the minimum number of cars can be charged in Tawang.
- The investment cost per km over 20 years of system life for the 8.1 kWp array with two days autonomy is INR 4.05 if monocrystalline panels are used and INR 4.09 if polycrystalline panels are used. Therefore, the least possible investment cost per km for a gasoline station is INR 5, and it can go up to INR 7.
- Despite having the same rated wattage, the monocrystalline panels have a better performance than the polycrystalline panels in terms of the energy supplied to EVs, CO<sub>2</sub> mitigation, and the investment cost per km.
- Compared to grid-tied EV charging stations, this station design does require 16 times more space. Still, its resilience and sustainability make it a good option for frontier regions such as Ladakh and Tawang, where grid availability is sparse.
- The current trend is to shift towards swappable batteries, and such a station can also be designed. Furthermore, chargers that are capable of charging different types of vehicles can also be used, and the system can be integrated with other forms of renewable energy, depending on the location.

**Author Contributions:** Conceptualization, N.P.G. and Y.R.S.; methodology, A.S. and S.S.S.; formal analysis, A.S. and S.S.S.; investigation, A.S. and S.S.S.; resources, A.S. and S.S.S.; writing—original draft preparation, A.S.; writing—review and editing, S.S.; visualization, S.S.; supervision, N.P.G. and Y.R.S.; project administration, A.G. All authors have read and agreed to the published version of the manuscript.

**Funding:** This work is supported by South Asia Partnership Development Fund, University of Exeter (UoE), UK, achieved by Aritra Ghosh (PI; UoE) and Shaik Saboor (CoI, VIT).

**Conflicts of Interest:** The authors declare no conflict of interest.

## References

1. Lahiri-Dutt, K. The Diverse Worlds of Coal in India: Energising the Nation, Energising Livelihoods. *Energy Policy* **2016**, *99*, 203–213. [CrossRef]
2. Press Trust of India. Electric Vehicle Market in India Expected to Hit 63 Lakh Units per Annum Mark by 2027: IESA. Available online: [https://yourstory.com/2020/12/electric-vehicle-market-india-expected-hit-63lakh-iesa/amp](https://yourstory.com/2020/12/electric-vehicle-market-india-expected-hit-63lakh-iesa/) (accessed on 8 July 2021).
3. Suzuki, K.; Kobayashi, Y.; Murai, K.; Ikezoe, K. Impact of EV Charging on Power System with High Penetration of EVs: Simulation and Quantitative Analysis Based on Real World Usage Data. In *SAE Technical Paper Series*; SAE International: Warrendale, PA, USA, 2020.
4. Kostopoulos, E.D.; Spyropoulos, G.C.; Kaldellis, J.K. Real-World Study for the Optimal Charging of Electric Vehicles. *Energy Rep.* **2020**, *6*, 418–426. [CrossRef]
5. Brenna, M.; Foadelli, F.; Leone, C.; Longo, M. Electric Vehicles Charging Technology Review and Optimal Size Estimation. *J. Electr. Eng. Technol.* **2020**, *15*, 2539–2552. [CrossRef]
6. Sharma, A.; Kapoor, A.; Chakrabarti, S. Impact of Plug-in Electric Vehicles on Power Distribution System of Major Cities of India: A Case Study. Available online: [https://home.iitk.ac.in/~{ansharma/EV\\_Report\\_V1.pdf](https://home.iitk.ac.in/~{ansharma/EV_Report_V1.pdf) (accessed on 9 July 2021).

7. Chandra Mouli, G.R.; Van Duijsen, P.; Grazian, F.; Jamodkar, A.; Bauer, P.; Isabella, O. Sustainable E-Bike Charging Station That Enables AC, DC and Wireless Charging from Solar Energy. *Energies* **2020**, *13*, 3549. [CrossRef]
8. Atmaja, T.D. Energy Storage System Using Battery and Ultracapacitor on Mobile Charging Station for Electric Vehicle. *Energy Procedia* **2015**, *68*, 429–437. [CrossRef]
9. Altaieb, H.; Rajnai, Z. Electric Vehicle Charging Infrastructure and Charging Technologies. *Haditehnika* **2020**, *54*, 8–12. [CrossRef]
10. Krishnan, G.; Mohammed Afsal, M.; Soby, E. College of Engineering Trivandrum. Smart Grid Implementation in India with HVDC Transmission and MicroGrids. *Int. J. Eng. Res. Technol.* **2017**, *6*, 383–388. [CrossRef]
11. Khan, M.S.A.W.; Ahmad, F.; Ahmad, A.; Alam, M.S. Feasibility Analysis of Electric Vehicle Charging Infrastructure Deployment in India. *India Smart Grid Forum Week* **2017**, *487*, 123–129.
12. Al Wahedi, A.; Bicer, Y. Development of an Off-Grid Electrical Vehicle Charging Station Hybridized with Renewables Including Battery Cooling System and Multiple Energy Storage Units. *Energy Rep.* **2020**, *6*, 2006–2021. [CrossRef]
13. De Simone, D.; Piegari, L. Integration of Stationary Batteries for Fast Charge EV Charging Stations. *Energies* **2019**, *12*, 4638. [CrossRef]
14. Di Benedetto, M.; Ortenzi, F.; Lidozzi, A.; Solero, L. Design and Implementation of Reduced Grid Impact Charging Station for Public Transportation Applications. *World Electric. Veh. J.* **2021**, *12*, 28. [CrossRef]
15. Badea, G.; Felseghi, R.-A.; Varlam, M.; Filote, C.; Culcer, M.; Iliescu, M.; Răboacă, M. Design and Simulation of Romanian Solar Energy Charging Station for Electric Vehicles. *Energies* **2018**, *12*, 74. [CrossRef]
16. Tze Wood, C. Design of Electric Vehicle Charging Station in Macau. *J. Asian Electric. Veh.* **2011**, *9*, 1453–1458.
17. Mouli, G.C.; Bauer, P.; Zeman, M. System design for a solar powered electric vehicle charging station for workplaces. *Appl. Energy* **2016**, *168*, 434–443. [CrossRef]
18. Goldin, E.; Erickson, L.; Natarajan, B.; Brase, G.; Pahwa, A. Solar Powered Charge Stations for Electric Vehicles. *Environ. Prog. Sustain. Energy* **2013**, *33*, 1298–1308. [CrossRef]
19. Kongjeen, Y.; Yenchamchalit, K.; Bhumkittipich, K. Optimal Sizing and Placement of Solar Powered Charging Station under EV Loads Penetration Using Artificial Bee Colony Technique. In Proceedings of the 2018 International Power Electronics Conference (IPEC-Niigata 2018 -ECCE Asia), Niigata, Japan, 20–24 May 2018.
20. Mohamed, K.; Wolde, H.K.; Alarefi, S.M.S. Optimal Space Utilisation for Solar Powered EV Charging Station. In Proceedings of the 2020 6th IEEE International Energy Conference (ENERGYCon), Gammarth, Tunisia, 28 September–1 October 2020.
21. Zhao, H.; Burke, A. An Intelligent Solar Powered Battery Buffered EV Charging Station with Solar Electricity Forecasting and EV Charging Load Projection Functions. In Proceedings of the 2014 IEEE International Electric Vehicle Conference (IEVC), Florence, Italy, 17–19 December 2014.
22. Martin. Sustainable Development Goals Kick off with Start of New Year. Available online: <https://www.un.org/sustainabledevelopment/blog/2015/12/sustainable-development-goals-kick-off-with-start-of-new-year/> (accessed on 9 July 2021).
23. Ghosh, A. Possibilities and Challenges for the Inclusion of the Electric Vehicle (EV) to Reduce the Carbon Footprint in the Transport Sector: A Review. *Energies* **2020**, *13*, 2602. [CrossRef]
24. Ayob, A.; Mohd Faizal Wan Mahmood, W.; Mohamed, A.; Zamri Che Wanik, M.; Mohd Siam, M.; Sulaiman, S.; Hanifah Azit, A.; Azrin Mohamed Ali, M. Review on Electric Vehicle, Battery Charger, Charging Station and Standards. *Res. J. Appl. Sci. Eng. Technol.* **2014**, *7*, 364–373. [CrossRef]
25. Singh, B.B.; Sharma, R.N.; Gill, J.P.S.; Aulakh, R.S.; Bangah, S. Climate Change, Zoonoses and India: -EN- -FR- Le Changement Climatique et Les Zoonoses En Inde -ES- Cambio Climático y Zoonosis En La India. *Rev. Sci. Tech.* **2011**, *30*, 779–788. [CrossRef] [PubMed]
26. Solar Resource Maps and GIS Data for 200+ Countries. Available online: <https://solargis.com/maps-and-gis-data/download/india> (accessed on 8 July 2021).
27. Available online: <https://weatherspark.com/> (accessed on 8 July 2021).
28. Pawar, N.; Nema, P. Optimum Sizing of PV Solar Based Standalone Energy System. In Proceedings of the 2020 International Conference on Inventive Computation Technologies (ICICT), Coimbatore, India, 26–28 February 2020.
29. Kumar, R.; Rajoria, C.S.; Sharma, A.; Suhag, S. Design and Simulation of Standalone Solar PV System Using PVsyst Software: A Case Study. *Mater. Today* **2020**, *46*, 5322–5328. [CrossRef]
30. Yadav, P.; Kumar, N.; Chandel, S.S. Simulation and Performance Analysis of a 1kWp Photovoltaic System Using PVsyst. In Proceedings of the 2015 International Conference on Computation of Power, Energy, Information and Communication (ICCPEIC), Melmaruvathur, India, 22–23 April 2015.
31. Tata Nexon EV—The Electric Compact SUV in India Powered by Ziptron. Available online: <https://nexonev.tatamotors.com/?id=home> (accessed on 9 July 2021).