

Article

# Non-Competitive and Competitive Adsorption of $\text{Pb}^{2+}$ , $\text{Cd}^{2+}$ and $\text{Zn}^{2+}$ Ions onto SDS in Process of Micellar-Enhanced Ultrafiltration

Xue Li <sup>1</sup>, Songbao He <sup>1</sup>, Chongling Feng <sup>2,\*</sup> , Yanke Zhu <sup>1</sup>, Ya Pang <sup>1</sup>, Juan Hou <sup>1</sup>, Kun Luo <sup>1</sup> and Xingsheng Liao <sup>1</sup>

<sup>1</sup> College of Biological and Environmental Engineering, Changsha University, Changsha 410003, China; gina0131@163.com (X.L.); abwhhsb@163.com (S.H.); zhuyanke4514@163.com (Y.Z.); pangya0989@ccsu.edu.cn (Y.P.); 17773964665@163.com (J.H.); luokun@ccsu.edu.cn (K.L.); z20120971@ccsu.edu.cn (X.L.)

<sup>2</sup> Institute of Environmental Science and Engineering Research, Central South University of Forestry & Technology, Changsha 410004, China

\* Correspondence: ddukepet@163.com; Tel.: +86-731-8562-3096

Received: 24 October 2017; Accepted: 27 December 2017; Published: 2 January 2018

**Abstract:** Competitive adsorption of  $\text{Pb}^{2+}$ ,  $\text{Cd}^{2+}$  and  $\text{Zn}^{2+}$  ions on sodium dodecyl sulfate (SDS) in binary mixtures were investigated compared with non-competitive adsorption in the unitary metal solution in micellar-enhanced ultrafiltration at a temperature of 25 °C. Mutual interference effects were investigated based on the removal rate, the Langmuir Competitive Model (LCM) and equilibrium adsorption capacity ratios,  $q_e/q_m$ , which indicated the presence of other metal ions. The results indicated that the removal rate and adsorption capacity of  $\text{Pb}^{2+}$  were higher than that of the other metal ions in unitary and binary systems. The effects on SDS micelles for Cd-Pb and Zn-Pb combinations were found to be antagonistic. However, it was a favorable effect for the Cd-Zn combination, and the metal ions sorption followed the order:  $\text{Pb}^{2+} > \text{Cd}^{2+} > \text{Zn}^{2+}$ . The behavior of non-competitive and competitive adsorption for  $\text{Cd}^{2+}$  and  $\text{Zn}^{2+}$  in a single system and in the presence of  $\text{Pb}^{2+}$  were well described by LCM. Moreover, the LCM showed poor fitting to non-competitive and competitive adsorption of  $\text{Pb}^{2+}$  in a single solution and in the presence of  $\text{Cd}^{2+}$  or  $\text{Zn}^{2+}$ . In conclusion, the removal of  $\text{Pb}^{2+}$  in the presence of  $\text{Zn}^{2+}$  or  $\text{Cd}^{2+}$  showed greater efficacy than that of  $\text{Cd}^{2+}$  or  $\text{Zn}^{2+}$  in the presence of  $\text{Pb}^{2+}$ .

**Keywords:** competitive adsorption; micellar-enhanced ultrafiltration (MEUF); heavy metal ions; sodium dodecyl sulfate (SDS)

## 1. Introduction

Wastewater carrying heavy metals has attracted widespread attention owing to the significant threat it poses to the environment and to human health [1]. Micellar-enhanced ultrafiltration (MEUF) is a surfactant-based separation technique which shows high removal efficiency of single metal ions or several kinds of metal ions simultaneously. Upon a surfactant being added into the polluted aqueous phase, it aggregates and forms micelles at a concentration higher than its critical micellar concentration (CMC). Micelle can facilitate the solubilization of organic matters and integrates them into its hydrophobic core or/and adsorb counter metal ions on its surface [2–5].

In recent times, research activities on absorption of heavy metals have focused on absorption efficiency from single component system or multi-component systems onto different adsorbents [6,7] and optimization of reaction conditions onto different adsorbents [8,9]. Among these studies, MEUF could remove many metal ions, including  $\text{Cd}^{2+}$ ,  $\text{Ni}^{2+}$ ,  $\text{Zn}^{2+}$  [10–12],  $\text{Cr}^{3+}$ ,  $\text{Mn}^{2+}$ ,  $\text{Pb}^{2+}$ ,  $\text{CrO}_4^{3-}$ ,  $\text{Cu}^{2+}$ ,

$\text{Fe}^{3+}$  and  $\text{Fe}(\text{CN})_6^{3-}$  [13–16]. Yenphan [17] reported the performance of single and mixed surfactants for removal of  $\text{Pb}^{2+}$  from aqueous solution and wastewater by MEUF. Akita [18] studied the MEUF to remove  $\text{Zn}^{2+}$  from aqueous solutions (up to 0.5 mmol/L) in the presence of cetylpyridinium chloride (CPC), polyoxyethylene nonylphenyl ether (PONPE10) and sodium dodecyl sulfate (SDS), the removal rate of  $\text{Zn}^{2+}$  were near to 0%, 8.7%, and 84.8%, respectively. Rujirawanicha [19] studied a continuous multistage ion foam fractionation column with bubble-cap trays being employed to remove cadmium ions from simulated wastewater having low-level cadmium ions (10 mg/L). Channarong [12] reported the simultaneous removal of nickel and zinc from aqueous solution by MEUF, and an activated carbon fiber (MEUF-ACF) hybrid process was performed at a constant permeate flow rate (40 mL/min) and operating retentate pressure (1 bar).

In previous studies, the MEUF process is usually described as follows: surfactants added to wastewater to form micelles, the charges of which attract oppositely charged heavy metal ions, and the micelles containing the heavy metal ions can be removed with an ultrafiltration membrane [20–22]. In other study fields, the simultaneous removal of organic and metal ions with MEUF such as chromate and chlorinated aromatic hydrocarbons, nitrate [23],  $\text{Cu}^{2+}$  and phenol [24],  $\text{Cr}^{3+}$  and phenols [25],  $\text{Cd}^{2+}$  and methylene blue [15], uranyl ions, as well as dissolved di-butyl phosphate (DBP) and tri-butyl phosphate (TBP) [26],  $\text{Cd}^{2+}$  and phenol [3], were investigated by several authors. Accordingly, it is highly desirable to use a surfactant system having a low CMC in order to reduce the surfactant concentration in permeate. Previous literatures [3,17,20] have shown addition of small amount of nonionic surfactant to an anionic surfactant, which usually results in a decrease in the CMC of the anionic-nonionic system compared with the CMC of the pure anionic. Little work has been done on the effect of the metal ions mixtures which have the same valence on SDS micelle adsorption ability and whether there exist competitive adsorption among them in MEUF. It is highly desirable to verify the competitive adsorption in order to provide high metal removal efficiency and reduce the surfactant concentration in permeate for wastewater containing multiple metal ions.

In this study, we investigated the competitive effects among  $\text{Pb}^{2+}$ ,  $\text{Cd}^{2+}$ , and  $\text{Zn}^{2+}$  on the sorption capability of SDS in binary component systems and the obtained results were discussed compared with the non-competitive data. SDS was chosen for its good removal efficiency, since it has opposite charge with metal ions. Furthermore, the present work studies the sorption dynamics of  $\text{Pb}^{2+}$ ,  $\text{Cd}^{2+}$ , and  $\text{Zn}^{2+}$  during their adsorption by SDS from unitary and binary component systems.

## 2. Materials and Methods

### 2.1. Chemicals

The chemical reagents used in these experiments were analytical reagent quality. All the experiments were prepared using distilled water which was produced by a water purification system (Labconco, KS, USA). Cadmium nitrate tetrahydrate ( $\text{Cd}(\text{NO}_3)_2 \cdot 4\text{H}_2\text{O}$ ) was procured from Shanghai Tingxin Chemical Reagent Company, China. Zinc nitrate hexahydrate ( $\text{Zn}(\text{NO}_3)_2 \cdot 6\text{H}_2\text{O}$ ) was purchased from Shiyi Reagent Co., Ltd., Shanghai, China. Lead Nitrate ( $\text{Pb}(\text{NO}_3)_2$ ) were obtained from Wenzhou Chemical Materials Plant, Wenzhou, China. SDS ( $\text{C}_{12}\text{H}_{25}\text{NaSO}_4$ ) was obtained from Tianjin Kermel Chemical Reagents Development Center, Tianjin, China.

### 2.2. Membrane

The Pellicon ultrafiltration membrane with molecular weight cut off (MWCO) of 10-kDa was used in this study without further treatment, which was purchased from Millipore Trading Co., Ltd., Shanghai, China. The membrane material is composite regenerated cellulose. The detailed properties of this membrane are given in Table 1.

**Table 1.** Characteristics of Pellicon ultrafiltration membrane. Molecular weight cut off (MWCO).

Type	Membrane Material	MWCO (Da)	Contour Size $\phi \times L$ (mm)	Effective Membrane Area ( $m^2$ )	Transmembrane Pressure (MPa)	Operating Temperature ( $^{\circ}C$ )	pH Operating Range
PLCGC	cellulose	10 k	30 $\times$ 188	0.005	<0.65	4–25	2–14

### 2.3. Experimental Setup and Analytical Instrument

The experimental setup used in this study was purchased from Millipore Trading Co., Ltd., Shanghai, China. The experimental setup consists of a cross-flow membrane container in which a composite regenerated cellulose membrane is settled, a stainless steel feed tank, a feed pump with firm power used to feed the solution into the membrane container, a refeed pressure gauge for showing the feeding aqueous solution pressure, and another for showing retentate pressure. A control knob is set in the right of feed pump to adjust the stirrer speed and the pump speed. A valve is placed behind retentate to adjust the operating pressure. Its schematic diagram is shown in Figure 1.

The concentration of SDS was measured by the methylene blue spectrophotometric method (ISO-7875-1-1996) with Shimadzu UV-2550 (P/N206-55501-93) spectrophotometer from Japan UV. The concentration of metal ions was analyzed by atomic absorption spectrometry with the instrument type of AAnalyst 700 (Perkin Elmer, Waltham, MA, USA) [3,15].

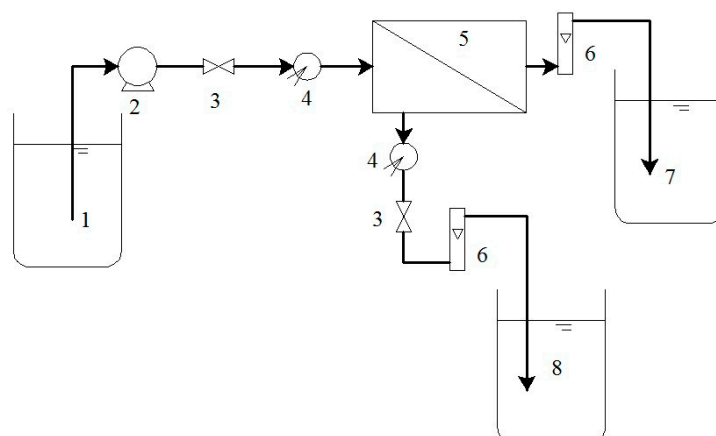

**Figure 1.** Schematic of the experimental setup: (1) feed tank; (2) feed pump; (3) control valve; (4) pressure gauge; (5) tangential ultrafiltration module; (6) rotameter; (7) permeate and (8) retentate.

### 2.4. Procedure

#### 2.4.1. Unitary System Sorption

$Pb(NO_3)_2/Zn(NO_3)_2 \cdot 6H_2O/Cd(NO_3)_2 \cdot 4H_2O$  were added into the deionized water to produce the synthetic wastewater with requisite concentration (10–200 mg/L), respectively. Then the surfactant SDS with its concentration from 0 to 2 CMC pre-determined were added into the synthetic wastewater (CMC of SDS is 2.25 g/L). In each experiment, the volume of feed solution was 2 L. After adequately mixed, the aqueous solution was subjected to the ultrafiltration process. When the feed solution was fully ultrafiltered, the process was stopped.

#### 2.4.2. Binary System Sorption

According to the experimental design, the synthetic wastewater was made by adding pre-determined amount of heavy metal and SDS into deionized water. In each experiment, 0.2–2.0 CMC of SDS (0.45–4.5 g/L) and 5–100 mg/L of single heavy metal ions were added for each of the combinations: Zn-Pb, Cd-Pb and Zn-Cd. Each of the metal ions was analyzed as described above.

After each ultrafiltration of the surfactant solution, the membrane was thoroughly washed to restore its original permeability. First, the distilled water was used to rinse out the residual SDS and metal ions in the membrane. Second, the feed solution filled the feed container with 500 mL cleaning solution of 25–40 °C was recycled for 30–60 min when the permeation flux was 30–50 mL/min through setting the pump control. Next, turn the pump off and discard the cleaning solution. Afterwards, the membrane normalized water permeability (NWP) which denotes the volume or mass of water per unit time through a unit membrane area under unit pressure was measured.

The NWP is calculated as follows:

$$NWP = \frac{Q \times F}{A \times \left\{ \left( \frac{P_{in} + P_{out}}{2} \right) - P_p \right\}} \quad (1)$$

where  $Q$  is the flow rate (L/h);  $A$  is the area of the ultrafiltration membrane ( $m^2$ );  $F$  is the correction coefficient;  $P_{in}$  is the inlet pressure (bar);  $P_{out}$  is the outlet pressure (bar);  $P_p$  denotes the permeate pressure (bar). After the membrane was used, the NWP value measured more than 80% of initial standard.

## 2.5. Calculations

### (1) Removal rate ( $R$ )

To evaluate the efficiency of ultrafiltration in removing the metal ions from solution, the removal rate  $R$  is expressed as

$$R = \frac{C_f - C_p}{C_f} \times 100\% \quad (2)$$

where  $C_f$  is the concentration of metal ions in the feeding solution (mg/L);  $C_p$  is the concentration of metal ions in the permeate (mg/L).

### (2) Adsorption capacity ( $\Gamma$ )

$$\Gamma = \frac{C_{f,m^{2+}} \times Q_f - C_{p,m^{2+}} \times Q_p}{C_{f,SDS} \times Q_f - C_{p,SDS} \times Q_p} \quad (3)$$

where  $\Gamma$  is the adsorption quantity for metal ions of per mass of adsorbent (mg/g);  $C_{f,SDS}$  is the concentration of SDS in the feed (g/L);  $C_{f,m^{2+}}$  is the concentration of metal ions in the feed (mg/L);  $C_{p,SDS}$  is the concentration of SDS in the permeate (g/L);  $C_{p,m^{2+}}$  is the concentration of metal ions in the permeate (mg/L);  $Q_f$  is the flux of feed (L/h);  $Q_p$  is the flux of permeate (L/h).

### (3) The Langmuir competitive model (LCM)

To study the nature of competition among  $Pb^{2+}$ ,  $Zn^{2+}$  and  $Cd^{2+}$  ions, the Langmuir competitive model was applied to the binary sorption equilibrium data. Similar to the monocomponent Langmuir model, in this model the rate of desorption still depends on only the adsorbing component. However, the rate of adsorption, must account for available sites only [i.e.,  $(1 - \sum_{i=1}^n \Phi_{m,i}^0)$ ]. When the model assumes that adsorption and desorption rate are equal, it can be shown that the extent of adsorption,  $q_{e,i}$  of the  $i$ th solute from an  $n$ -solute mixture is represented by:

$$q_{e,i} = q_{m,i} K_{L,i} C_{e,i} \left( 1 + \sum_{j=1}^n K_{L,j} C_{e,j} \right)^{-1} \quad (4)$$

where  $q_{m,i}$  and  $K_{L,i}$  are physical parameters, and  $C_{e,i}$  are equilibrium concentrations in the mixture of the solutes. In a system where the concentrations of the solutes are sufficiently large that surface coverage is substantially complete, the unit term in Equation (4) may be neglected, and after some algebraic manipulation, the expression can be linearized as shown in Equation (5) [27].

$$\frac{C_{e,1}}{C_{e,2}q_{e,1}} = \frac{C_{e,1}}{q_{m,1}C_{e,2}} + \frac{K_{L,2}}{K_{L,1}q_{m,1}} \quad (5)$$

Plots of  $C_{e,1}/C_{e,2}q_{e,1}$  as a function of  $C_{e,1}/C_{e,2}$  would give intercepts of  $K_{L,2}/K_{L,1}q_{m,1}$  and a slope of  $1/q_{m,1}$  for the binary system.

### 3. Results and Discussion

#### 3.1. Effect of Feed SDS Concentration and Feed Concentration of Metal Ion on Metal Removal for Single-Ion Situation

The feed metal ions concentration and the operating pressure were fixed at 50 mg/L and 0.083 MPa. The feed SDS concentration was 0.2–2.0 CMC (0.45–4.5 g/L). Variation of the removal of metal ions with feed SDS concentration was shown in Figure 2. With increasing SDS concentration, micelles were formed and their numbers increased. Theoretically, there were no micelles formed at the SDS concentration below 1.0 CMC, and no metal ions high removal was expected (except some metal ions were adsorbed by membrane). When the surfactant concentration in the aqueous stream exceeds or closes to 1.0 CMC, the surfactant monomers will assemble and aggregate to form micelles. Consequently, more metal ions could be adsorbed in micelles. However, it is observed that the removal of  $Pb^{2+}$  is maintained above 93% when the feed SDS concentration ranges from 0.45 to 4.5 g/L. Meanwhile, the removal of  $Zn^{2+}$  increased from 35% to 95% and from 32% to 97% for  $Cd^{2+}$ , and then their trends toward gentle. In solution containing single metal, heavy metal ions compete with  $H^+$  that exist in solution [3,18,28]. The variation of removal rate for  $Pb^{2+}$  was different from the other two metal ions, which indicated the competitive binding ability of  $Pb^{2+}$  was much higher than that of  $Zn^{2+}$  and  $Cd^{2+}$ . In any case, it can be learned from Figure 2 that they attain high removal efficiency when the feed SDS concentration is 0.8 CMC (1.8 g/L).

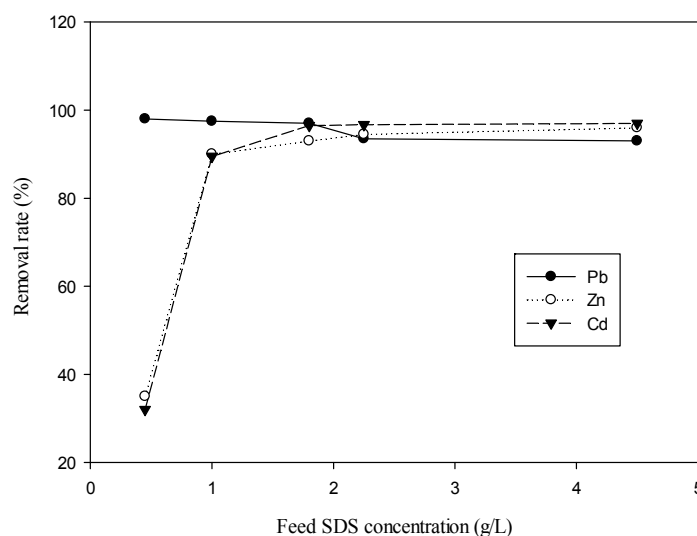

**Figure 2.** Effects of feed sodium dodecyl sulfate (SDS) concentration on removal rate of  $Pb^{2+}$ ,  $Zn^{2+}$  and  $Cd^{2+}$  in unitary metal solution. Feed metal ions concentration, 50 mg/L; Operating pressure, 0.083 MPa.

In order to study the effect of feed concentration of metal ions, the SDS concentration in feed was fixed at 1.8 g/L and the operating pressure of 0.083 MPa was applied to the micelle adsorption. The experiments were carried out by varying the feed concentration of metal ions from 10 mg/L to 200 mg/L. Figure 3 shows that the removal rate of  $Zn^{2+}$  and  $Cd^{2+}$  were all above 90.0% before their concentration reached 100 mg/L, and then fell to 78.6% when the concentration was raised to 200 mg/L. On the other hand, the removal rate of  $Pb^{2+}$  increased sharply from 89.5% to 98.0% with

feed concentration from 15 mg/L to 30 mg/L and then decreased slightly at feed concentration of 200 mg/L. It was observed that the removal of  $Pb^{2+}$ ,  $Zn^{2+}$  and  $Cd^{2+}$  reached their maximum values, which was 98.0%, 97.3% and 97.2%, respectively, when feed concentration was 30 mg/L. When the concentration increased to above 30 mg/L, the removal order was found to be  $Pb^{2+} > Cd^{2+} > Zn^{2+}$ .

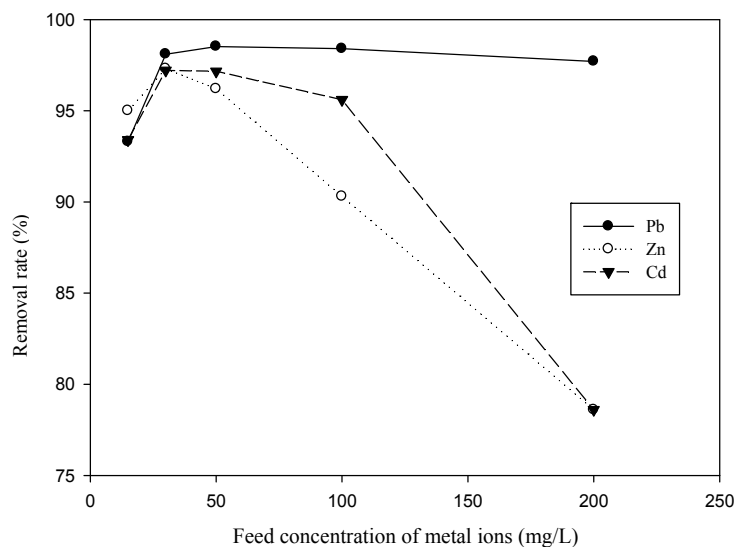
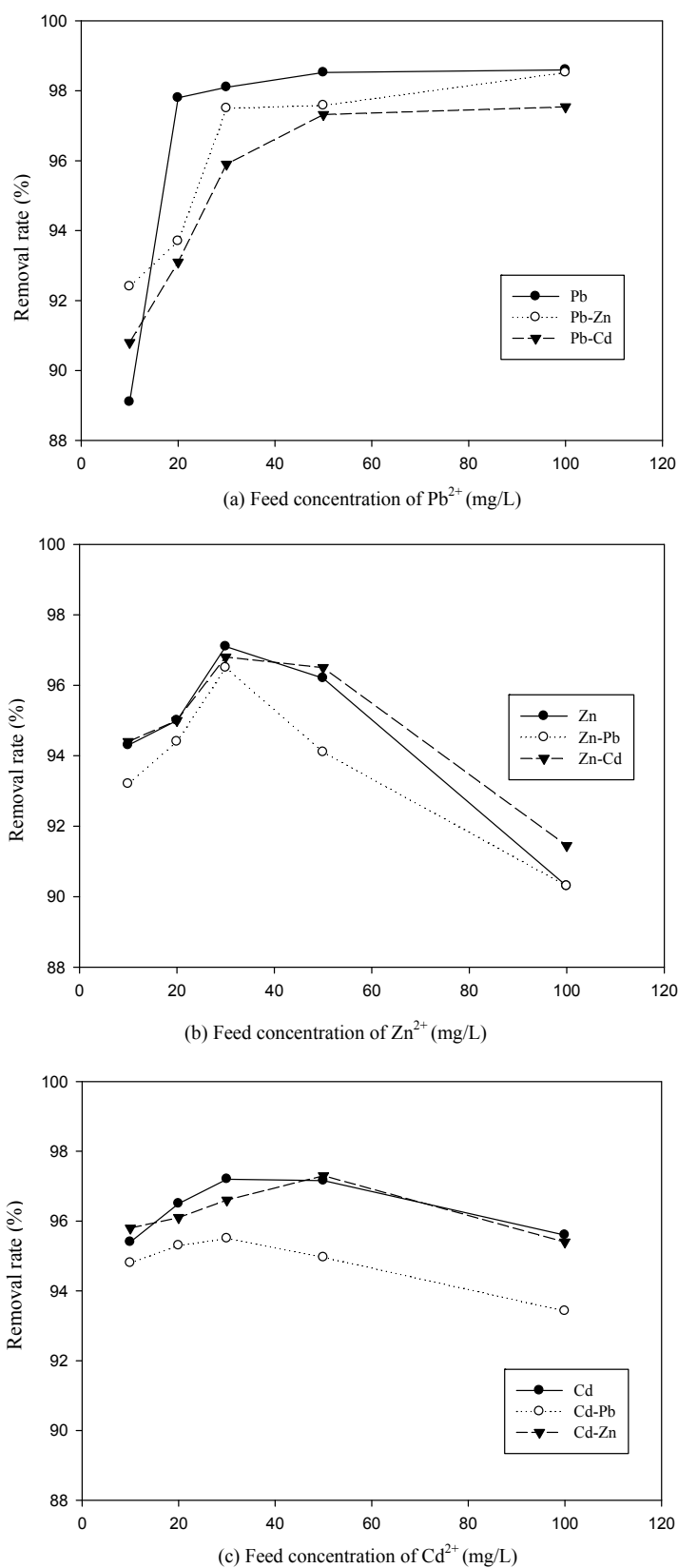

**Figure 3.** Effects of feed concentration of metal ions ( $Pb^{2+}$ ,  $Zn^{2+}$ ,  $Cd^{2+}$ ) on the removal rate in unitary metal solution. Feed SDS concentration, 1.8 (g/L); Operating pressure, 0.083 MPa.

### 3.2. Effect of Feed Concentration of Metal Ions on Metal Removal Efficiency in Binary System

To investigate the competitive adsorption on  $Pb^{2+}$ ,  $Zn^{2+}$ , and  $Cd^{2+}$  in the micelle of SDS, the experiments were carried out by varying the concentrations of each cation in the range of 10–100 mg/L in binary system. Under the condition of the same total feed concentration of metal ions, the relationship between concentration of metal ions and the percent removal were shown in Figure 4a–c. The removal rate varies with concentration of metal ions in single solute and mixed solutes to different extent. When the concentrations of  $Zn^{2+}$  and  $Cd^{2+}$  were all above 30 mg/L, the removal rates began to decline. The reduced removal rate of metal ions can be explained by the dosage of SDS. In this work, with the feed concentration of SDS fixed at 0.8 CMC, the adsorption capacity and sites of SDS which formed micelles of fix amount in aqueous solution were fixed. Once the concentration of metal ions was increased continuously, the removal rate of metal ion had slowed down significantly, while the removal of  $Pb^{2+}$  had been increasing and then kept at 99%. It was demonstrated that the adsorption behavior of SDS for  $Pb^{2+}$  was distinguished from  $Zn^{2+}$  and  $Cd^{2+}$ .

An intercomparison of removal efficiency of metal ions in single system and binary system showed that they have changed under the conditions of the same content of metal ions. According to Figure 4b,c, the removal rate of  $Zn^{2+}$  in a single system was higher than that in the Zn-Pb system or the Zn-Cd system. The removal of  $Cd^{2+}$  also showed similar trends. This phenomenon exactly indicated that there existed competitive adsorption among them in MEUF.



**Figure 4.** (a–c) Variation of  $Pb^{2+}$ ,  $Zn^{2+}$  and  $Cd^{2+}$  removal rate in unitary and binary metal solution, respectively. Feed SDS concentration, 1.8 (g/L); Operating pressure, 0.083 MPa.

### 3.3. The Competitive Effects of Ions from Binary System Sorption

The dynamical competitive effects of the mixture were further probed using the ratio of the sorption capacity for the metal in the binary-metal system ( $q_e$ ) to the sorption capacity for the same metal in the single-metal system ( $q_m$ ). When  $q_e/q_m > 1$ , synergism (the sorption is promoted in the presence of the other metal ions);  $q_e/q_m = 1$ , non-interaction (the mixture has no effect on the sorption of each of the adsorbates in the mixture);  $q_e/q_m < 1$ , antagonism (the sorption is antagonistic in the presence of other metal ions).

As shown in Table 2, the values of the ratios for the sorption of one metal in the presence of another metal were all  $< 1$ , indicating that the adsorption of the metals was depressed, so presence of another metal seemed to be an adverse effect for the mixtures. The values of ratios for the sorption of  $Pb^{2+}$  ions in the presence of  $Cd^{2+}$  and  $Zn^{2+}$  ions were 0.61 and 0.6, respectively. Similar trends were observed for the effect of  $Pb^{2+}$  ions on the sorption of  $Zn^{2+}$  and  $Cd^{2+}$  ions ( $q_e/q_m = 0.67$  and 0.63, respectively). Obviously, the suppression effect of  $Pb^{2+}$  ions on  $Cd^{2+}$  and  $Zn^{2+}$  adsorption was greater than the interaction effect of  $Cd^{2+}$  and  $Zn^{2+}$  ions ( $q_e/q_m = 0.71$  and 0.73). Therefore, these findings suggest that there was an antagonistic effect of one metal on binding of the other metal, with  $Pb^{2+}$  showing the greater effect. Interestingly, the adsorbed amount of SDS micelles for Pb-Cd (59.55 mg/g) and Pb-Zn (59.31 mg/g) were higher than that of  $Pb^{2+}$  (49.37 mg/g),  $Zn^{2+}$  (44.18 mg/g) and  $Cd^{2+}$  (47.27 mg/g) ions alone. For that reason, the adsorption sites of  $Pb^{2+}$ ,  $Zn^{2+}$  and  $Cd^{2+}$  may partially be overlapped in binary. Moreover, the total adsorption capacity for Cd-Zn (66.05 mg/g) was greater than the single component values for  $Cd^{2+}$  (47.27 mg/g) and  $Zn^{2+}$  (44.18 mg/g). Thus these values indicated that sorption sites of Cd and Zn were likely to be different, which showed a synergistic effect between  $Zn^{2+}$  and  $Cd^{2+}$  [28].

**Table 2.** Unitary and binary system adsorption parameters. Langmuir Competitive Model (LCM).

System	Metal Ion (+Interferent)	$q_{e,exp}$ (mg/g)	$Q_{max}$ (mg/g)	$q_e/q_m$	$K_{L,2}/K_{L,1}$	$R^2$
(a) Pb as primary metal ion		Langmuir model				
Unitary	Pb	49.37	-	1		
Binary	Pb-Zn	29.86	-	0.6	6.41	
	Pb-Cd	29.94	-	0.61		
(b) Cd as primary metal ion		Langmuir model				
Unitary	Cd	47.27	151.51	1		0.99
Binary	Cd-Pb	29.6	35.84	0.63	3.02	1
	Cd-Zn	33.47	-	0.71		
(c) Zn as primary metal ion		Langmuir model				
Unitary	Zn	44.18	136.98	1		0.98
Binary	Zn-Pb	29.45	58.41	0.67		0.95
	Zn-Cd	32.58	-	0.73		

As stated previously, the sorption order was found to be  $Pb^{2+} > Cd^{2+} > Zn^{2+}$  in binary system. These phenomena can be explained by the physicochemical properties of the ions.  $Zn^{2+}$  and  $Cd^{2+}$  ions have the same coordination number, similar diamagnetism, charge and have very similar electronegativity. These similar ionic properties would imply that the two ions compete similarly with the  $Pb^{2+}$  ions. The preference of the sorbent for the  $Pb^{2+}$  ions may be due to the fact that the metal ions have the largest atomic weight and paramagnetic, the most electronegative ion and has the highest standard reduction potential compared to  $Zn^{2+}$  and  $Cd^{2+}$  ions. These ionic properties make  $Pb^{2+}$  most likely to be adsorbed [8,11].



### 3.4. Application of the LCM to Binary System

The graphs plotted based on Equation (5), and the adsorption parameters obtained were shown in Figure 5 and Table 2.

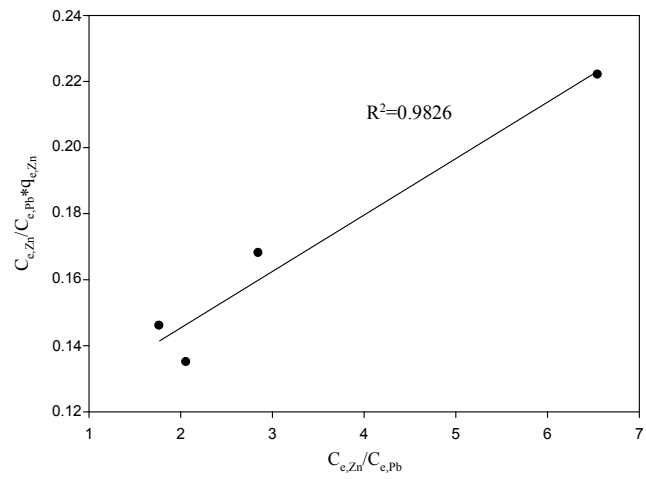

(a) Sorption of  $Zn^{2+}$  in the presence of  $Pb^{2+}$

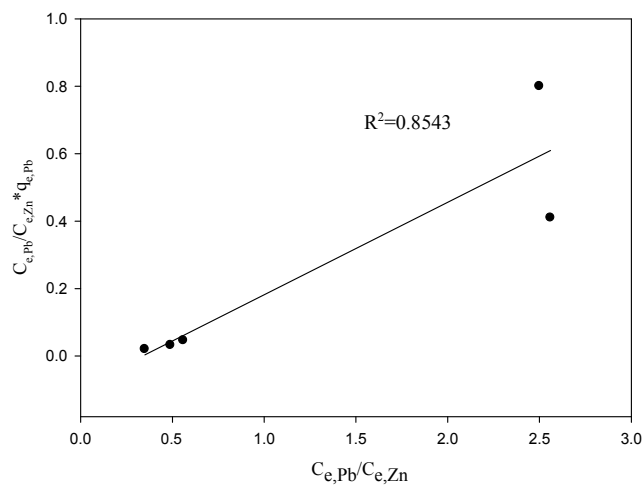

(b) Sorption of  $Pb^{2+}$  in the presence of  $Zn^{2+}$

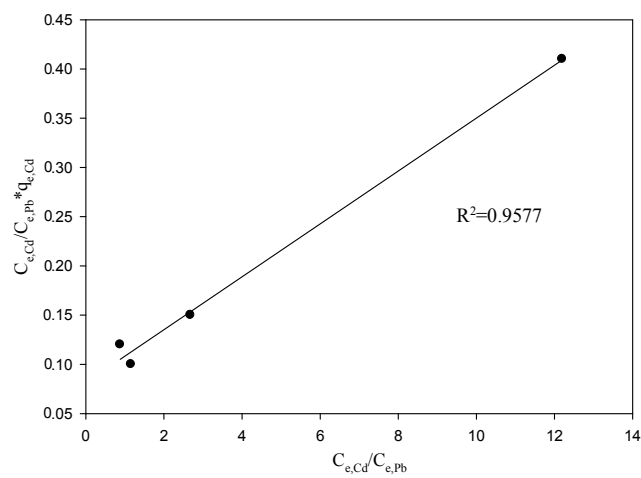

(c) Sorption of  $Cd^{2+}$  in the presence of  $Pb^{2+}$

Figure 5. Cont.

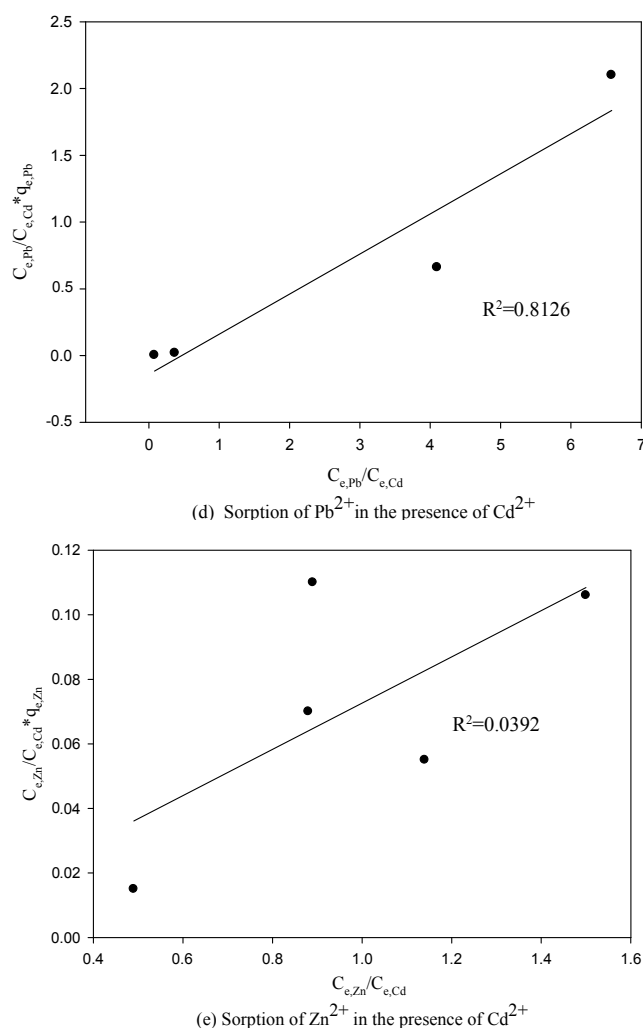

**Figure 5.** (a–e) Fitting curve of competitive Langmuir model plots for the binary sorption. Feed SDS concentration, 1.8 (g/L); Operating pressure, 0.083 MPa.

The Langmuir model plots provided the best correlation for both  $Cd^{2+}$  and  $Zn^{2+}$  and a worse correlation for  $Pb^{2+}$ . The binary combinations in which  $Zn^{2+}$  and  $Cd^{2+}$  are the primary ions for Zn-Pb and Cd-Pb fitted the LCM with  $R^2 > 0.95$ , but when the  $Pb^{2+}$  is the primary ion for Pb-Cd and Pb-Zn combinations did not fit the LCM well since  $0.8 < R^2 < 0.9$ . However, the Cd-Zn and Zn-Cd combinations showed poor fitting to LCM with  $R^2 < 0.04$ . These results indicated that there was competitive interaction in the sorption of  $Pb^{2+}$  ions either of  $Zn^{2+}$  or  $Cd^{2+}$  ions. There was no significant competitive effect between the  $Cd^{2+}$  ions and  $Zn^{2+}$  ions in their adsorption by SDS micelles in the investigated concentration range. The information obtained from the competitive model shows no specific interactions between solutes to enhance adsorption. Thus, there are no clearly identified sorption sequences observed here. Adsorption preference of an adsorbent for different kinds of adsorbates may be related to the solution chemistry (e.g., pH, ionic strength, etc.), the physicochemical properties of the adsorbates (e.g., concentration, ionic size, ionic charge, ionic weight, standard redox potential, etc.), and the characteristics of the binding sites (e.g., structure, functional groups, surface properties, etc.). It appears elusive at the moment to be conclusive on how these physicochemical properties affect the selectivity of the sorption process for the adsorbent [29]. In short, it could be seen that the three ions partially share the binding sites on the surface of SDS micelles, with the presence of  $Pb^{2+}$  introducing competitive interaction with  $Cd^{2+}$  and  $Zn^{2+}$  individually.

#### 4. Conclusions

In the present study, the removal efficiency and the adsorption capacity for the removal of  $\text{Pb}^{2+}$ ,  $\text{Cd}^{2+}$  and  $\text{Zn}^{2+}$  ions by SDS in process of MEUF showed that their uptake from unitary and binary systems both followed the order:  $\text{Pb}^{2+} > \text{Cd}^{2+} > \text{Zn}^{2+}$ . Sorption equilibrium data correlated with Langmuir and Langmuir Competitive Model (LCM). The multi-element effects on SDS were found to be best fit in Zn-Pb and Cd-Pb system to LCM. However, the Pb-Cd and Pb-Zn system did not fit well with the LCM. The Zn-Cd combination showed the poorest fitting to LCM. The sorption of binary mixture of heavy metal solution on SDS micelle was found to be competitive where the suppression effect of  $\text{Pb}^{2+}$  ions on  $\text{Cd}^{2+}$  or  $\text{Zn}^{2+}$  adsorption was greater than the interaction effect of  $\text{Cd}^{2+}$  and  $\text{Zn}^{2+}$  ions in binary system. While there was a favorable effect for Cd-Zn combination owing to synergism between  $\text{Cd}^{2+}$  and  $\text{Zn}^{2+}$ , the removal of  $\text{Pb}^{2+}$  in the presence of  $\text{Zn}^{2+}$  or  $\text{Cd}^{2+}$  showed greater effectively than the removal of  $\text{Cd}^{2+}$  or  $\text{Zn}^{2+}$  in the presence of  $\text{Pb}^{2+}$ .

**Acknowledgments:** This study was financially supported by the National Natural Science Foundation of China (51308076, 51779090, and 51709285) and the Hunan Provincial Science and Technology Department (2016SK2045, 2017SK2240), the Ministry of Science and Technology, China (2012GS430203, 2012BAC09B03).

**Author Contributions:** Xue Li organized this study, conducted the study design, performed the statistical analysis, and drafted the manuscript. Songbao He performed the statistical analysis, polished the paper. Chongling Feng contributed to the study design, and drafted the manuscript. Yanke Zhu contributed to the experimental studies, performed the data analysis. Ya Pang contributed to interpretation of analysis, and revision of the manuscript. Juan Hou contributed to the experimental studies and prepared the datasets. Kun Luo and Xingsheng Liao contributed to preparing the datasets and the revision of the manuscript. All authors read and approved the final manuscript.

**Conflicts of Interest:** The authors declare no conflict of interest.

#### References

- Huang, J.H.; Liu, W.C.; Zeng, G.M.; Li, F.; Huang, X.L.; Gu, Y.L.; Wan, J. An exploration of spatial human health risk assessment of soil toxic metals under different land uses using sequential indicator simulation. *Ecotoxicol. Environ. Saf.* **2016**, *129*, 199–209. [[CrossRef](#)] [[PubMed](#)]
- Huang, J.H.; Li, F.; Zeng, G.M.; Liu, W.C.; Huang, X.L.; Xiao, Z.H.; He, Y. Integrating hierarchical bioavailability and population distribution into potential eco-risk assessment of heavy metals in road dust: A case study in Xiandao District, Changsha city, China. *Sci. Total Environ.* **2015**, *541*, 969–976. [[CrossRef](#)] [[PubMed](#)]
- Li, X.; Zeng, G.M.; Huang, J.H.; Zhang, D.M.; Shi, L.J.; He, S.B.; Ruan, M. Simultaneous removal of cadmium ions and phenol with MEUF using SDS and mixed surfactants. *Desalination* **2011**, *276*, 136–141. [[CrossRef](#)]
- Li, F.; Zhang, J.D.; Jiang, W.; Liu, C.Y.; Zhang, Z.M.; Zhang, C.D.; Zeng, G. Spatial health risk assessment and hierarchical risk management for mercury in soils from a typical contaminated site, China. *Environ. Geochem. Health* **2017**, *39*, 923–934. [[CrossRef](#)] [[PubMed](#)]
- Lai, C.; Wang, M.M.; Zeng, G.M.; Liu, Y.G.; Huang, D.L.; Zhang, C.; Wu, H.P. Synthesis of surface molecular imprinted  $\text{TiO}_2$ /graphene photocatalyst and its highly efficient photocatalytic degradation of target pollutant under visible light irradiation. *Appl. Surf. Sci.* **2016**, *390*, 368–376. [[CrossRef](#)]
- Hasan, S.; Talat, M.; Rai, S. Sorption of cadmium and zinc from aqueous solutions by water hyacinth (*Eichhornia crassipes*). *Bioresour. Technol.* **2007**, *98*, 918–928. [[CrossRef](#)] [[PubMed](#)]
- Tharani, A.; Harish, R.; Mageshkumar, P.; Ramesh, S. Comparative study on removal of heavy metals from textile industry wastewater using various adsorbent. *Int. J. Adv. Sci. Eng. Res.* **2017**, *2*, 12–22.
- Fagundesken, M.R.; Vaz, L.G.L.; Veit, M.T.; Borba, C.E.; Silva, E.A.; Kroumov, A.D. Biosorption of the copper and cadmium ions—A study through adsorption isotherms analysis. *Int. J. Bioautom.* **2007**, *7*, 23–33.
- Mehrizad, A.; Gharbani, P. Study of 1-chloro-4-nitrobenzene adsorption on carbon nanofibers by experimental design. *Int. J. Nano Dimens.* **2016**, *7*, 77–84.
- Li, X.; Zeng, G.M.; Huang, J.H.; Zhang, C.; Fang, Y.Y.; Qu, Y.H.; Liu, H.L. Recovery and reuse of surfactant SDS from a MEUF retentate containing  $\text{Cd}^{2+}$  or  $\text{Zn}^{2+}$  by ultrafiltration. *J. Membr. Sci.* **2009**, *337*, 92–97. [[CrossRef](#)]
- Plazinski, W.; Rudzinski, W. Modeling the Effect of pH on Kinetics of Heavy Metal Ion Biosorption. A Theoretical Approach Based on the Statistical Rate Theory. *Langmuir* **2009**, *25*, 298–304. [[CrossRef](#)] [[PubMed](#)]

12. Channarong, B.; Seunghwan, L.; Bade, R.; Shipin, O.V. Simultaneous removal of nickel and zinc from aqueous solution by micellar-enhanced ultrafiltration and activated carbon fiber hybrid process. *Desalination* **2010**, *262*, 221–227. [[CrossRef](#)]
13. Kedari, C.S.; Pandit, S.S.; Tripathi, S.C. Extraction of Am(III) from aqueous nitrate solutions into micellar pseudo phase of anionic or non-ionic surfactant and separation by ultrafiltration. *J. Membr. Sci.* **2009**, *341*, 122–130. [[CrossRef](#)]
14. Huang, J.H.; Yuan, F.; Zeng, G.M.; Li, X.; Gu, Y.L.; Shi, L.X.; Shi, Y. Influence of pH on heavy metal speciation and removal from wastewater using micellar-enhanced ultrafiltration. *Chemosphere* **2017**, *173*, 199–206. [[CrossRef](#)] [[PubMed](#)]
15. Zeng, G.M.; Li, X.; Huang, J.H.; Zhang, C.; Zhou, C.F.; Niu, J.; Li, F. Micellar-enhanced ultrafiltration of cadmium and methylene blue in synthetic wastewater using SDS. *J. Hazard. Mater.* **2011**, *185*, 1304–1310. [[CrossRef](#)] [[PubMed](#)]
16. Baek, K.; Yang, J.W. Removal of ferricyanide using micellar enhanced ultrafiltration (MEUF). *Dev. Chem. Eng. Miner. Process* **2005**, *13*, 137–146. [[CrossRef](#)]
17. Yenphan, P.; Chanachai, A.; Jiratananon, R. Experimental study on micellar-enhanced ultrafiltration (MEUF) of aqueous solution and wastewater containing lead ion with mixed surfactants. *Desalination* **2010**, *253*, 30–37. [[CrossRef](#)]
18. Akita, S.; Yang, L.; Takeuchi, H. Micellar-enhanced ultrafiltration of gold(III) with nonionic surfactant. *J. Membr. Sci.* **1997**, *133*, 189–194. [[CrossRef](#)]
19. Rujirawanich, V.; Chavadej, S.; O'Haver, J.H.; Rujiravanit, R. Removal of trace Cd<sup>2+</sup> using continuous multistage ion foam fractionation: Part I-The effect of feed SDS/Cd molar ratio. *J. Hazard. Mater.* **2010**, *182*, 812–819. [[CrossRef](#)] [[PubMed](#)]
20. Huang, J.H.; Zhao, Y.; Zeng, G.M.; Peng, L.; Li, X.; Liu, L.X.; Yuan, F. Micellar-enhanced ultrafiltration for the solubilization of various phenolic compounds with different surfactants. *Water Sci. Technol.* **2015**, *72*, 623–631. [[CrossRef](#)] [[PubMed](#)]
21. Huang, J.H.; Shi, L.J.; Zeng, G.M.; Li, X.; He, S.B.; Li, F.; Xie, G.X. Effects of feed concentration and transmembrane pressure on membrane fouling in Cd<sup>2+</sup> removal by micellar-enhanced ultrafiltration. *Desalination* **2012**, *294*, 67–73. [[CrossRef](#)]
22. Li, F.; Qiu, Z.; Zhang, J.; Liu, W.; Liu, C.; Zeng, G.M. Investigation, Pollution Mapping and Simulative Leakage Health Risk Assessment for Heavy Metals and Metalloids in Groundwater from a Typical Brownfield, Middle China. *Int. J. Environ. Res. Public Health* **2017**, *14*, 768. [[CrossRef](#)] [[PubMed](#)]
23. Baek, K.; Yang, J.W. Simultaneous removal of chlorinated aromatic hydrocarbons, nitrate, and chromate using micellar-enhanced ultrafiltration. *Chemosphere* **2004**, *57*, 1091–1097. [[CrossRef](#)] [[PubMed](#)]
24. Tung, C.C.; Yang, Y.M.; Chang, C.H.; Maa, J.R. Removal of copper ions and dissolved phenol from water using micellar-enhanced ultrafiltration with mixed surfactants. *Waste Manag.* **2002**, *22*, 695–701. [[CrossRef](#)]
25. Witek, A.; Koltuniewicz, A.; Kurczewski, B.; Radziejowska, M.; Hatalski, M. Simultaneous removal of phenols and Cr<sup>3+</sup> using micellar-enhanced ultrafiltration process. *Desalination* **2006**, *191*, 111–116. [[CrossRef](#)]
26. Misra, S.K.; Mahatele, A.K.; Tripathi, S.C.; Dakshinamoorthy, A. Studies on the simultaneous removal of dissolved DBP and TBP as well as uranyl ions from aqueous solutions by using Micellar-Enhanced Ultrafiltration Technique. *Hydrometallurgy* **2009**, *96*, 47–51. [[CrossRef](#)]
27. Huang, C.P.; Smith, E.H. Removal of Cd(II) from plating waste water by an activated carbon process. In *Chemistry in Water Reuse*; Cooper, W.J., Ed.; Ann Arbor Science Publishers: Ann Arbor, MI, USA, 1981; Volume 2, pp. 355–398.
28. Huang, J.H.; Zeng, G.M.; Zhou, C.F.; Li, X.; Shi, L.J.; He, S.B. Adsorption of surfactant micelles and Cd<sup>2+</sup>/Zn<sup>2+</sup> in micellar-enhanced ultrafiltration. *J. Hazard. Mater.* **2010**, *183*, 287–293. [[CrossRef](#)] [[PubMed](#)]
29. Mahamadi, C.; Nharingo, T. Competitive adsorption of Pb<sup>2+</sup>, Cd<sup>2+</sup> and Zn<sup>2+</sup> ions onto *Eichhornia crassipes* in binary and ternary systems. *Bioresour. Technol.* **2010**, *101*, 859–864. [[CrossRef](#)] [[PubMed](#)]

