

Article

Achieving Sustainability of Traditional Wooden Houses in Indonesia by Utilization of Cost-Efficient Waste-Wood Composite

Meng-Ting Tsai *  and Anthony Sugiharto Wonodihardjo

Department of Architecture, National Taiwan University of Science and Technology, Taipei 10607, Taiwan; tonix_swt@yahoo.co.id

* Correspondence: tsai@mail.ntust.edu.tw; Tel.: +886-2-2730-3212

Received: 21 March 2018; Accepted: 22 May 2018; Published: 24 May 2018



Abstract: Although Indonesians have for many years used wood to build traditional houses, currently it is difficult to find new traditional houses made from wood. Since wood is too expensive for local people, concrete becomes the major construction material instead. However, wood is considered a sustainable material that is eco-friendly, recyclable, and has less of an environmental impact than concrete. In this study, an innovative and cost efficient waste-wood composite structure was proposed with the intention of fulfilling local demand for the construction of traditional wooden houses, as well as supplying a sustainable and cost-efficient wooden product in the construction sector. Four small pieces of waste wood connected with steel nails or self-tapping screws were assembled into a rectangular waste-wood composite, serving as secondary beam, column, or brace. These waste-wood composites are considered recyclable and low-cost, and provide an alternative solution for local people that achieves an affordable and sustainable construction system. The assembled wood components were tested under single shear in order to clarify the structural performance of connection and the failure modes. The comparison of the experimental results and predicted results showed that the predicted strength is considered in a conservative manner for further application. In addition, the cost estimation and comparison between a solid wood structure and the waste-wood composite structure indicated that the price of the waste-wood composite structure is potentially competitive and cost-efficient for the local people, which was optimistic for future development.

Keywords: waste-wood composite; yield strength; failure mode; cost efficient; sustainable

1. Introduction

The communal longhouses on stilts with steep sloping roofs and heavy gables were the major feature of earliest Austronesian structures, which could be seen in the traditional Batak house and Torajan Tongkonan (Figure 1a). Variations of the communal longhouse principle have been found among the Dayak of Borneo and the Mentawai of Nias Island. Typically, a post, beam, and lintel structural system transfer the load straight to the ground with either wooden or bamboo walls that do not bear any load [1]. The structural system of these types of traditional houses is illustrated in Figure 1b. Traditionally, mortise-and-tenon joints with wooden pegs are used in place of nails. Hardwood is generally used for piles, whereas softwood is used for the upper non-load-bearing walls. Currently, fulfilling local people's demand for wood to build these types of houses is becoming difficult. The growing global population has decreased forested areas, which has affected the global supply and availability of wood.

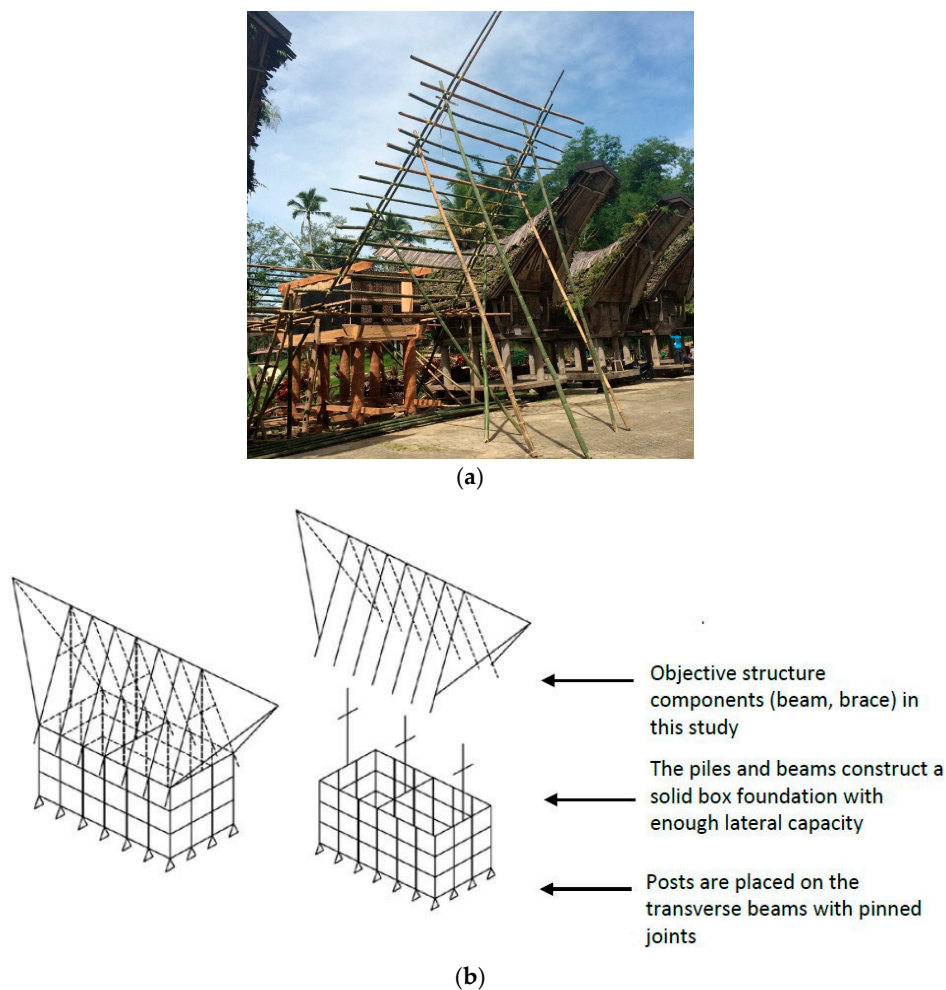

Figure 1. Traditional House Batak and Torajan Tongkonan and structure system. (a) Traditional House Batak and Torajan Tongkonan, (b) structure system.

Due to the raising concern of global warming, wooden products are considered a carbon pool that is strategically managed to reduce the emission of carbon dioxide. The efficient use of wooden products improved the sustainability of the forest-wood chain, and potentially mitigated climate change [2,3]. In Indonesia, because the price of wood is no longer affordable for the local people, concrete became the major construction material for these traditional houses. However, wood is considered an eco-friendly, sustainable, and recyclable material, and less environmental impact is raised compared with the use of the concrete. It is important to provide an alternative solution for local people to achieving a sustainable construction system by the utilization of wood as a major construction material. A strategy of adoptable reuse, both functionally and materially, is important for these traditional houses as well [4].

Presently, recycling is at the heart of waste disposal. What most people simply refer to as “recycling” involves numerous activities. A concept of recycling is presented as a circular economy (CE), while cascading utilization (CU) is considered actively integrated with a circular economy [5]. When a material can be recycled and used more than once, the value of CU gets higher, enhancing the value of the CE. The cascade factor is used for estimating the efficiency of cascading utilization; for example, the more multiple uses that a material has, the higher its cascade factor [6]. For wood in the construction sector, solid wood or engineered wood is the major product, considering the first or secondary products in the cascade chain. The used solid wood or engineered wood is down-cycled to manufacture panel or chipboard, which can potentially increase the cascade factor. On the other

hand, some of the wooden products from the wood residue, such as biomass, are getting popular in order to replace the fuel energy [7–9]. Meanwhile, other wood residue is used for composite products, such as wood–plastic composite, in order to reduce the impact of plastic materials on the environment [8]. In Indonesia, most of waste woods are used for producing chipboard or are burned in power stations. To achieve this, the waste wood is industrially processed and then shipped long distances, often overseas, which has a major carbon footprint. However, a large portion of waste wood is reusable. Although high-quality wood or wood products should not be down-cycled into wood chips or burned, no other disposal or recycling methods are available for such products, since the last part of the cascade chain is even waste. In this study, the waste-wood composite structure is proposed in order to increase the efficiency of wood recycling and increase the value of cascading utilization (CU).

In general, the advantages of manufacturing the waste-wood composite were obvious, including the utilization of wood as a sustainable and eco-friendly construction material that provides a potential cost-efficient waste-wood composite structure as an alternative to concrete. Hence, the waste-wood composite potentially reduces the impact on the general environment, and preserves the traditional wooden construction system. Therefore, this study decided to turn waste parts of cutting proportion into an innovative waste-wood composite that was connected with steel nails or self-tapping screws, and was considered cheaper and affordable for local people. This waste-wood composite structure is expected to be used to make sustainable and cost-efficient traditional Indonesian houses. From a load transmission perspective, the compressive strength of the proposed waste-wood composite structure relies on the properties of the wood species. However, the nail connection provides shear resistance for either the buckle resistance on the column or the bending resistance on the beam. Hence, it is essential to clarify the failure mode and yield strength of the connections through shear tests by applying two common wood species prior to conducting a full-scale experiment. Furthermore, the cost estimation between solid wood and a waste-wood composite were compared in order to ensure the cost efficiency and affordability of the proposed waste-wood composite.

2. Waste-Wood Composite Structure

The goal of this study was to develop an innovative waste-wood composite structure in an affordable, efficient, and sustainable manner, which could be used by local people to build their houses in Indonesia. The wood specimens were randomly taken from the waste of a local sawmill, as shown in Figure 2. The properties of the waste-wood composite structures are described in this section.

2.1. Structural Issues

The proposed waste-wood composite structure is expected to be applied by the parts that are illustrated in Figure 3 (secondary columns, beams, and braces), and the section of waste wood is shown in Figure 4. The compressive strength is affected by the properties of the wood species. The fastener becomes vital when considering the bending resistance on the beam or the buckling resistance on the column and brace. When bending or buckling occurs, each connected individual element is expected to slip [10,11]. The shear resistance provided by the fasteners prevents failure caused by bending or buckling. For an estimation of shear strength, a recent study estimated and simulated the shear resistance of a nail connection and a screw connection using the finite element method, with the results indicating that the structure behavior can be simulated successfully [12–14]. However, it is a technical issue for industries without the required advanced simulation tools to generate the shear resistance of a connector. Yield theory, which is considered simple and direct, is used to predict the yield strength of a fastener subjected to shear, which can be predicted by the diameter of the connector [15–18]. Hence, in order to examine the feasibility of using domestic plantations to develop a waste-wood composite structure, fundamental studies are required to investigate the shear resistance of different metal fasteners on local wood prior to full-scale structure tests.



Figure 2. Wasted wood in a local sawmill company.

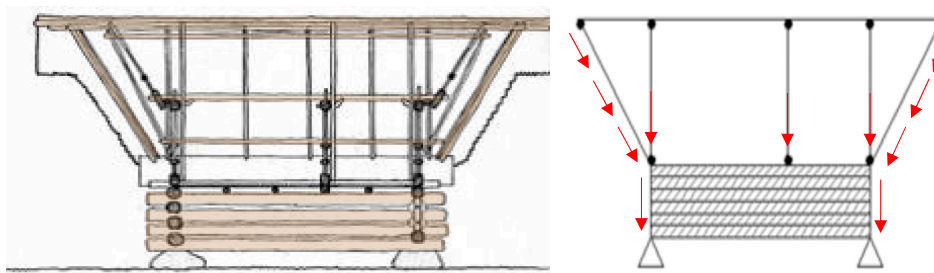

Figure 3. Load transmission mechanism of a traditional house.



Figure 4. Wooden species: (Left) Silkwood; (Right) Indonesia Rosewood.

2.2. Materials

Two local wood species were used in this study, both of which were generally available in the market from a sawmill factory in Indonesia. The first species was *Paraserianthes falcataria* (Silkwood), which is classified as a softwood, and is abundant because it spreads naturally over almost every island in Indonesia. In West Java, where growing conditions such as evergreen forests are optimal, Silkwood is an essential commercial wood species that is used for pulp, paper, and furniture. Silkwood is also suitable for general purposes such as light construction (e.g., rafters, paneling, interior trimming, furniture, and cabinetwork). The wood is a valuable source of lightweight veneer and plywood, which is especially suitable for the manufacture of light-density and medium-density particleboard, wood-wool board, and hardboard, as well as blockboard. Most Silkwood waste is burned as a traditional fuel or is unused by local people because of a lack of knowledge of reusing sawmill waste. The second species used in this study was *Dalbergia latifolia* (Indonesian Rosewood or Java Palisandre), which is classified as a hardwood and ornamental plant that is native to tropical parts of Africa and Asia, such as Indonesia and India. Under the appropriate conditions, such as monsoon or evergreen forests, Indonesian Rosewood can even grow quickly to 40 m. Indonesian Rosewood is used mostly for furniture and decoration components. Due to a high international demand for the wood, local sawmills endeavor to export it, which has created a higher stack of waste wood. Hence, finding an efficient use for this waste wood is vital. The mechanical properties of both wood specimens are shown in Table 1 [19].

Table 1. Physical and mechanical properties of Silkwood and Indonesia Rosewood.

Physical and Mechanical Properties		
Silkwood	Density (kg/m ³)	330
	Modulus of Elasticity (MOE) (N/mm ²)	4450
	Modulus of Rupture (MOR) (N/mm ²)	53
Indonesia Rosewood	Density (kg/m ³)	770
	Modulus of Elasticity (MOE) (N/mm ²)	7650
	Modulus of Rupture (MOR) (N/mm ²)	75

2.3. Assembling the Waste-Wood Composite Structure

Most of the structural components in traditional Indonesian houses are made from solid wood, which is naturally cut from a forest. Solid wood is generally expensive, and is difficult to find because locals prefer to sell it to the furniture market rather than use it to build traditional houses. A waste-wood composite structure is one solution, because it can be used as a construction component. To improve awareness in the construction culture, the unused parts of good quality wood, as shown in Figure 5a, can be assembled into a composite wood structure, as illustrated in Figure 5b. Numerous methods exist for assembling a composite wood structure, such as glue and metal connectors. After consideration of the local conditions, metal connectors were used to assemble the proposed waste-wood composite structure for practicality and efficiency. Studies have indicated that the size of the connectors results in a different embedment strength between wood and fasteners, which influences the shear resistance of the fasteners [20–23]. In this study, steel nails and self-tapping screws (Figure 6) were used as connectors, because they are easily accessible in the local market. The embedment strength and shear resistance of self-tapping screws apply to the same wooden species, which is greater than that of steel nails [24–26]. However, the strength combined with different wooden species and different fasteners will be further examined in this study. The CN-50 steel nail that was used in the experiment was 4 mm in diameter (d) and 75 mm in length (L). The #10-24 self-tapping screw that was 4.5 mm (d) and 89 mm (L) was used, and the thread length (L1) was 65 mm. The fasteners used in this study were available in the local market, while some other available fasteners were not an industrialized product. The dimensions of the assembled waste-wood composite structure

are shown in Figure 7; the length (L_w) of each waste wood varied from 30 mm to 50 mm, and contact surface (L_c) was 10 mm. Hence, it is expected to provide the waste-wood composite structures with a cross-section of 60 mm × 60 mm to 100 mm × 100 mm approximately.

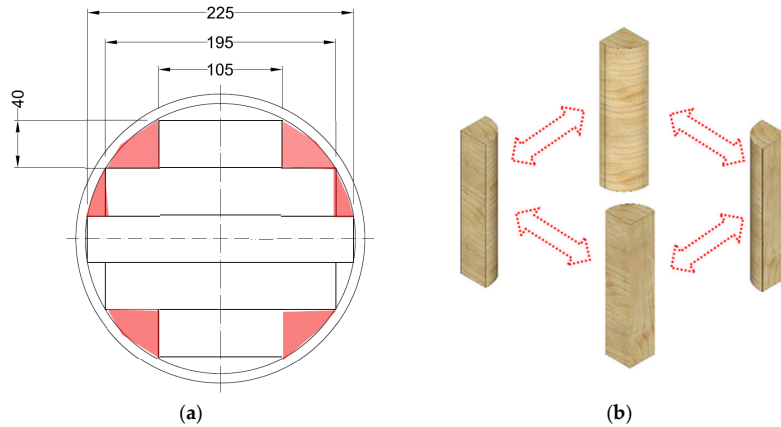

Figure 5. The innovative combination of wasted wood (unit: mm). (a) Unused part of wood (red part), (b) assembled illustration.

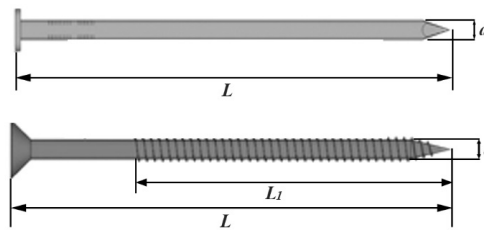

Figure 6. Fasteners used for the experiment, nail and screw.

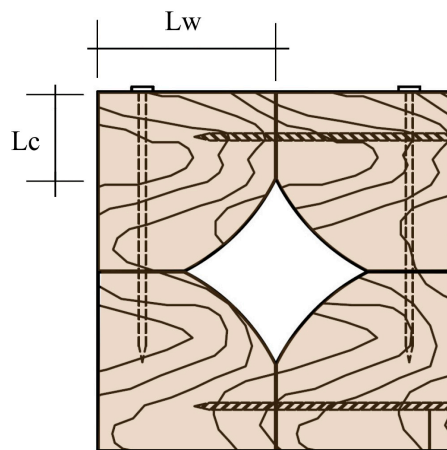

Figure 7. Assembled waste-wood composite structure with fasteners.

3. Methodology

To clarify the structural performance of the different metal fasteners, experiments were conducted to observe the failure mechanism of the connections in the waste-wood composite structure under single shear. Various yield theories were applied to obtain the yield strength from the experimental data. Foschi and United States (U.S.) 5% nail diameter yield theories were applied to determine the yield strength obtained from the experimental results. Although the concept of these two theories

is similar, the difference between the yield strength obtained from these two theories examined the variations between these theories. Smith yield theory was then applied to predict and estimate the yield strength based on the properties of the wood species, steel nails, and self-tapping screws. Smith yield theory is the method for the designer to estimate and predict the yield strength without experiment. The yield strength values obtained from the experiments (Foschi and U.S. 5%) and predicted values (Smith) were then compared in order to examine the accuracy of the prediction. The theories were explained in the following section, and the physical and mechanical properties shown in Table 1 was used for the calculation in this study.

3.1. Yield Theory

Three yield theories were used to determine the yield strength of the wooden joints. Smith theory [15,16] was used to predict the yield strength, whereas U.S. 5% nail diameter offset theory [15] and Foschi yield load theory [17] were used to obtain the yield strength from the experimental data.

(1) Smith Yield Load Theory

Smith yield load theory was used to predict the yield strength of the test specimens; the equation was shown in Equations (1)–(6), and three geometrical variables were used for predicting yield strength, such as embedment strength, the ultimate yield stress of the fastener, and the diameter of the fastener. The lowest value of the determined yield strength (P_y) was used for further simulation in the full-scale model of the waste-wood composite structure.

$$P_{ymin} = SHdl \quad (1)$$

$$P_{ymin} = SHdl\alpha\beta \quad (2)$$

$$P_{ymin} = \frac{SHdl \{ [2\beta(1 + \beta) + 4\beta(2 + \beta)d^3fy / (6SHdl^2)] - \beta \}}{2 + \beta} \quad (3)$$

$$P_{ymin} = \frac{SHdl\alpha \{ [2\beta^2(1 + \beta) + 4\beta(1 + 2\beta)d^3fy / (6SHdl^2\alpha^2)] - \beta \}}{2 + \beta} \quad (4)$$

$$P_{ymin} = \frac{SHdl \{ [\beta + 2\beta^2(1 + \alpha + \alpha^2) + \beta^3\alpha^2] - \beta(1 + \alpha) \}}{1 + \beta} \quad (5)$$

$$P_{ymin} = 4d^3 \left[\frac{10\beta SH}{1 + \beta} \right] [fy/240]^{1/2} \quad (6)$$

where SH is the nail embedment strength = $0.068 \delta (d/6) - 0.36$ (N/mm²), d is the nail diameter (mm), l is the length of the shorter member (mm), fy is the nail yield stress = $50(16 - d)$ (N/mm²), α is a modification factor for the length = $L/(L - Lp)$, L is the length of the fastener, and Lp is the penetration length of fastener on the point-side member, β is a modification factor for the embedment strength = SH (head-side member)/ SH (point-side member), and δ is the density of wood (kg/m³).

(2) Foschi Yield Load Theory

Foschi yield load theory derived a finite element model to predict the load-slip function of shear strength between nails and woods, using the elastic-plastic foundation of the beam. The non-elastic model was capable of being used for estimating the crushing of the timber underneath the nail. The equation can be expressed as follows:

$$P = (P_0 + P_1x) \cdot (1 - e^{-k \cdot x / P_0}) \quad (7)$$

where P is the reaction force of the foundation (N), P_0 is the intercept of the first asymptote with the Y-axis (N), P_1 is the slope of the asymptote (N/mm), x is displacement (mm), and k is initial stiffness

(N/mm). For perfecting yield strength, $P1 = 0$, whereas the constants k , $P1$, and $P0$ can be acquired from experimental data. Foschi’s model was adopted by researchers to determine the point of yield strength, and the curves that were used to determine the point of yield strength can be illustrated as shown in Figure 8. Through the use of the parameters from Equation (7), the yield load ($Pyld$) can be estimated as the intercept of the lines with an initial slope line having a slope k and first asymptote line having a slope $k1$ based on the curve obtained from the load-slip curve of the experimental result. At this point, the interception point can be as Equation (8).

$$Pyld = \frac{k1P0}{k - k1} + P0 \tag{8}$$

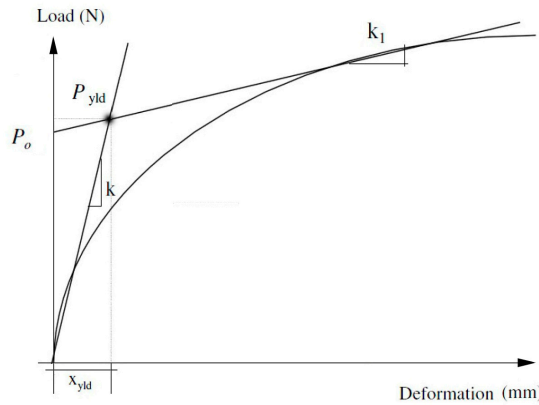

Figure 8. Yield load define by Foschi to obtain yield load.

(3) U.S. 5% Offset Yield Load Theory

U.S. 5% offset yield load theory is similar to Foschi yield load theory, while load–slip relationships were obtained from the testing results. These load–slip curves were used to obtain the first asymptote linear equation. The asymptote line was almost the same as the proportional limit in the elastic method. The yield loads were obtained from a 5% nail diameter offset line relative to the first asymptote line, as presented in Equation (9), where m is the gradient of the line, Y is the load at X slip, X is the slip at Y load, d is the nail diameter, and b is a constant. Figure 9 illustrates a typical load–slip curve for a nailed joint, the letters A, B, C, and D represent the load–slip curve, first asymptote line, 5% diameter offset line, and load–slip curves, respectively.

$$Y = m(X + 5\%d) + b \tag{9}$$

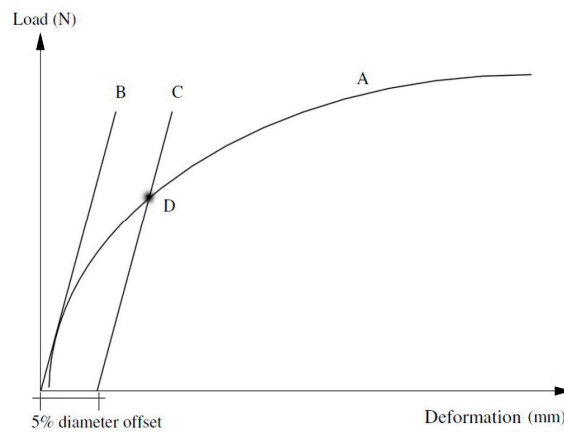

Figure 9. United States (U.S.) 5% nail diameter offset theory.

3.2. Experiment

The single shear test with different combinations of wood species and metal fasteners followed ASTM D1761-Standard Test Methods for Mechanical Fasteners in Wood under a displacement control rate of 2 mm/min. The results were expected to inspire models of complete structures in future research. Overall, 24 specimens combined with Silkwood and Indonesian Rosewood were obtained from a local sawmill in Indonesia, with steel nails or self-tapping screws, were assembled and tested in this study, as concluded in Table 2. The specimens for the shear test were assembled by using two pieces of wood measuring 75 mm in length and connected by one of two types of metal joints, with one type comprising steel nails and the other comprising self-tapping screws. The three combinations for the wooden specimens were type S–S (Silkwood and Silkwood), type R–R (Indonesian Rosewood and Indonesian Rosewood), and type S–R (Silkwood and Indonesian Rosewood). When considering the fabrication of specimen type S–R, Silkwood was always the Sh_1 member due to the workability of inserting fasteners with low-density wood, with the crack often detected while taking Indonesian Rosewood (hard wood) as Sh_1 member. The combinations are illustrated in Figure 10, where Sh_1 is the embedment strength on the head-side member, and Sh_2 is the embedment strength on the point-side member. The length of L_1 and L_2 varies depending on the waste wood that was supplied and selected, approximately between 3 cm to 5 cm. The specimens were manufactured before being fastened; the fasteners were drilled to combine the two specimens. Figure 11 shows the mechanism of the single shear load test, and the contact surface of two combined specimens was 50 mm.

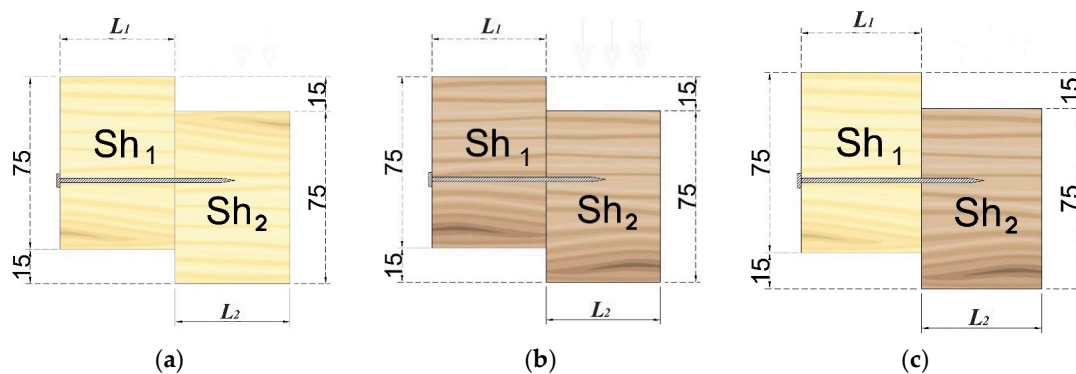

Figure 10. Assembly configuration, unit: mm (light color: Silkwood, dark color: Rosewood). (a) Type SS-N/S, (b) Type RR-N/S, (c) Type SR-N/S. SS: Silkwood and Silkwood; RR: Indonesian Rosewood and Indonesian Rosewood; SR: Silkwood and Indonesian Rosewood. N: nail; S: screw.

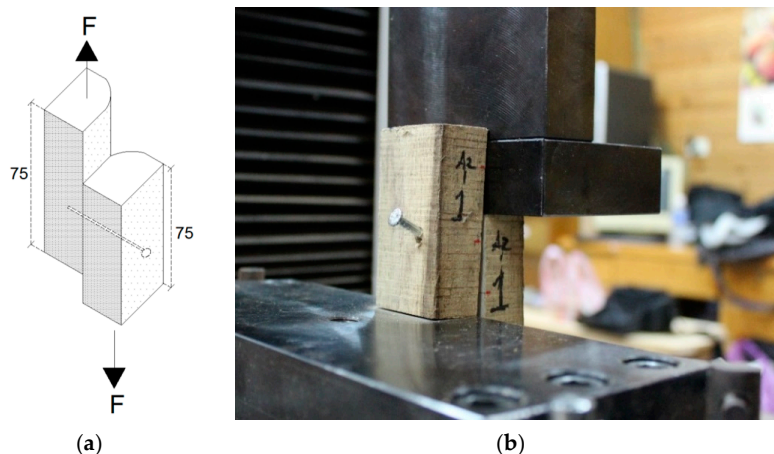

Figure 11. Shear load testing (unit: mm). (a) load direction, (b) testing setup.

Table 2. Type of specimens.

Type	Connection Descriptions	No. of Specimens
SS-N-i	Silkwood and Silkwood fastened by Nail	4
SS-S-i	Silkwood and Silkwood fastened by Screw	4
RR-N-i	Rosewood and Rosewood fastened by Nail	4
RR-S-i	Rosewood and Rosewood fastened by Screw	4
SR-N-i	Silkwood and Rosewood fastened by Nail	4
SR-S-i	Silkwood and Rosewood fastened by Screw	4

4. Experimental Results and Discussion

According to the test results, the load–displacement relationship is illustrated in Figures 12–17. The analysis and results are discussed as follows.

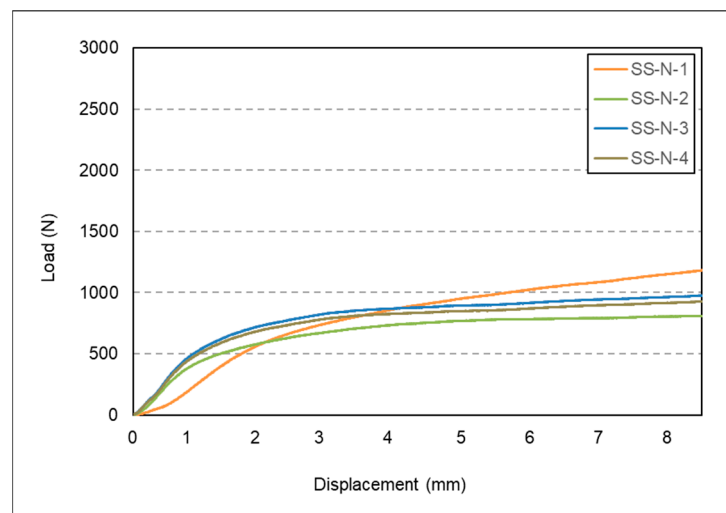

Figure 12. Load–displacement relationship of type SS-N.

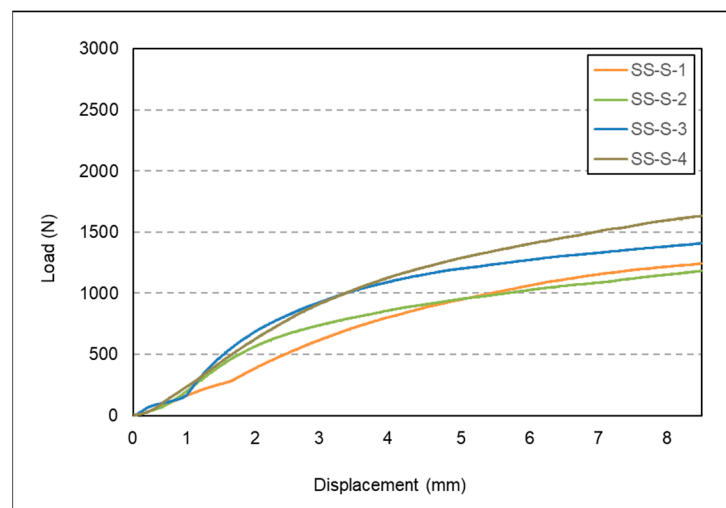

Figure 13. Load–displacement relationship of type SS-S.

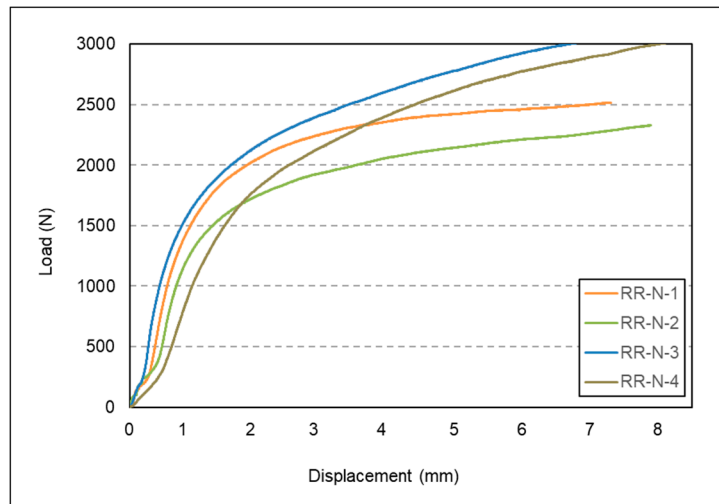

Figure 14. Load–displacement relationship of type RR-N.

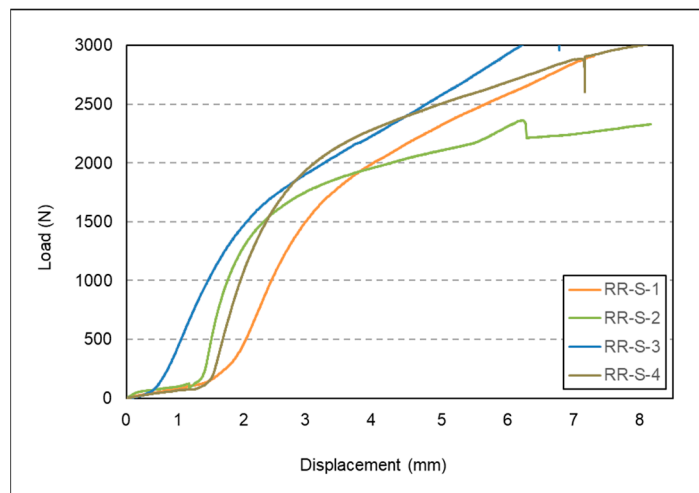

Figure 15. Load–displacement relationship of type RR-S.

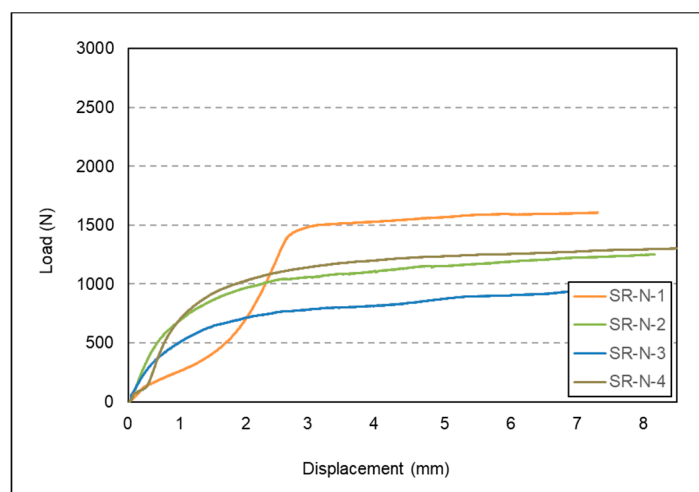

Figure 16. Load–displacement relationship of type SR-N.

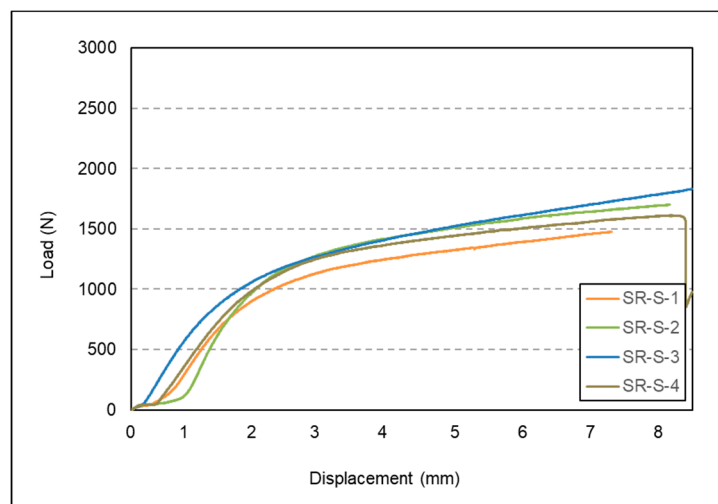

Figure 17. Load–displacement relationship of type SR-S.

4.1. Failure Modes

According to the test results, the types of failure modes were observed in accordance with the combination of the wooden specimens and fasteners. Thus, the typical failure mode for each combination could be clarified.

(1) Failure Modes of Specimen Type SS-N/S

Two failure modes were observed in specimen type SS-N/S. The failure mode of specimen type SS-N, which was fastened by nails, showed that the fasteners remained stiff when the specimens were damaged. Based on the results, the typical failure mode entailed the crushing of the head-side member (Sh1) and point-side member (Sh2). This failure mode can be attributed primarily to the low density of the Silkwood. The failure mode of specimen type SS-S is presented in Table 3, which shows the bending of the fasteners and crushing at the Sh2.

(2) Failure Modes of Specimen Type RR-N/S

One major failure mode occurred in specimen type RR-N/S, as illustrated in Table 4. The failure mode of specimen type RR-N (fastened by steel nails) showed that the nails bent at both the Sh1 and Sh2. Conversely, the fasteners in specimen type RR-S bent at the Sh2.

(3) Failure Modes of Specimen Type SR-N/S

Two failure modes occurred in specimen type SR-N/S, as illustrated in Table 5. The failure mode of SR-N showed that the fasteners properly penetrated the Sh2, which was hardwood. However, the steel nails were bent and crushed in the Sh1. The major failure mode of specimen type SR-S involved damage to the Sh1, which was softwood, with the self-tapping screws remaining stiff inside the Sh2. In the second failure mode of specimen type SR-S, no fasteners were broken, but major damage occurred in the softwood.

4.2. Maximum Shear Load

The maximum shear load values are summarized in Table 6. The shear load values for the combinations of the specimens using Silkwood (softwood) fastened by steel nails were generally the lowest, with the maximum shear loads between 814 N to 1025 N, according to the difference of the cross-section. When the self-tapping screws were applied, the maximum shear load increased by approximately 75% above that of the steel nail. The specimens involving the combination of Silkwood and Indonesian Rosewood presented comparable results, which were 1329 N (steel nails) and 1757 N

(self-tapping screws), on average. The load value of the specimen fastened by self-tapping screws was approximately 32% higher than that of the specimen fastened by steel nails, indicating the importance of the fasteners. Moreover, the combinations of the specimens using Rosewood (hardwood) presented the highest shear test values; however, the maximum load values were close when comparing the steel nails (among 2514 N to 3155 N) and self-tapping screws (among 2363 N to 3139 N). According to the results, it is understood that with the increasing of the wooden density, the shear strength that is influenced by the wooden property declines. The yield strength obtained from experiment in this study was reliable when compared with the performance of wood joints fastened with power-driven nails [27], the yield strengths were 1234 N by hammer, and 1141 N by power-driven tools. Thus, the shear resistance is majorly influenced by the bending strength of the fastener. It is evidenced that the failure modes in this type SR-N/S (hardwood) is the bent of the fasteners.

4.3. Estimation of Yield Strength

Three yield theories were applied in this study. Smith yield load theory was used to predict yield strength when the properties of the materials were determined. To examine the accuracy of the predicted yield strength, the yield strengths obtained from the experimental results based on both Foschi yield load theory and U.S. 5% nail diameter offset yield load theory were compared.

The yield strengths of the specimens fastened by steel nails that were obtained from different yield theories are summarized and illustrated in Figures 18–20. The yield strength predictions were slightly different because of variations in the waste-wood sections. The difference between the values obtained from the experimental and predicted results were summarized and presented in Table 7. The tests confirmed that the predicted yield strength was mostly lower than the values from the tests, which can be considered in a conservative manner for further application. The only exception was specimen type S–R(N) (the combination of Silkwood and Indonesian Rosewood), where the yield strength obtained from U.S. 5% offset yield load theory was approximately 9% lower than the predicted yield strength. Therefore, Smith yield load theory can be used to predict the yield strength for these types of connections. The yield strengths of the specimens fastened by self-tapping screws obtained from different yield theories are summarized and illustrated in Figures 21–23. According to the results, the predicted yield strength was conservative and smaller when compared with the values obtained from the experiments; therefore, the predicted yield strength is considered applicable.

Table 3. Failure Modes of Specimen Type SS.

Specimen		Failure Modes
Type	Typical Failure	
SS-N-1 SS-N-2 SS-N-3 SS-N-4		

Table 3. Cont.

Specimen		Failure Modes
Type	Typical Failure	
SS-S-1 SS-S-2 SS-S-3 SS-S-4		

Table 4. Failure Modes of Specimen Type RR.

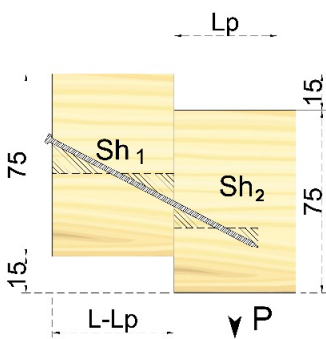

Specimen		Failure Modes
Code	Result	
RR-N-1 RR-N-2 RR-N-3 RR-N-4		
RR-S-1 RR-S-2 RR-S-3 RR-S-4		

Table 5. Failure Modes of Specimen Type SR.

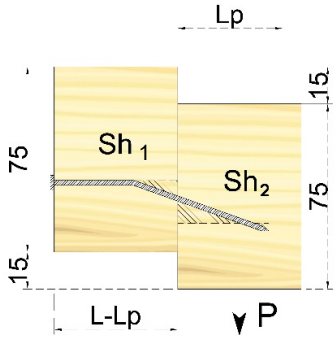

Specimen		Failure Modes
Code	Result	
SR-N-1 SR-N-2 SR-N-3 SR-N-4		
SR-S-1 SR-S-2 SR-S-3 SR-S-4		

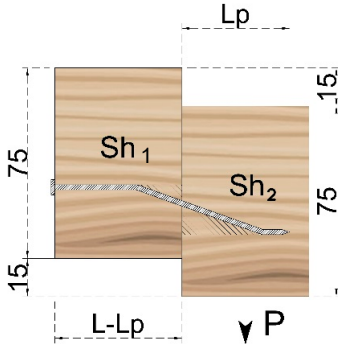
Table 6. Maximum Shear Load.

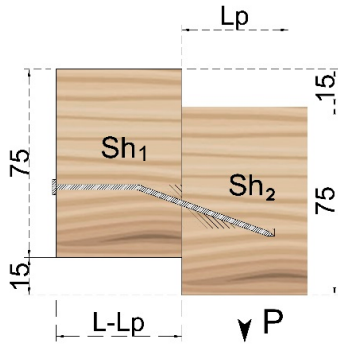
Details of Specimen			Maximum Load (N)
Specimens Type	Cross-Section (mm)		
S-S	SS-N-1	32 × 58	814.84
	SS-N-2	33 × 70	945.32
	SS-N-3	32 × 67	1025.78
	SS-N-4	33 × 65	988.74
	Mean value	33 × 65	943.67
R-R	RR-S-1	37 × 56	1516.02
	RR-S-2	25 × 60	1530.86
	RR-S-3	30 × 68	1701.95
	RR-S-4	31 × 61	1839.84
	Mean value	31 × 41	1647.17
R-R	RR-N-1	23 × 45	2701.56
	RR-N-2	24 × 43	2514.06
	RR-N-3	45 × 84	3248.44
	RR-N-4	43 × 80	3155.86
	Mean value	34 × 63	2904.98
R-R	RR-S-1	40 × 88	2914.84
	RR-S-2	32 × 65	2363.28
	RR-S-3	40 × 85	3139.45
	RR-S-4	28 × 65	2887.11
	Mean value	35 × 76	2826.17

Table 6. Cont.

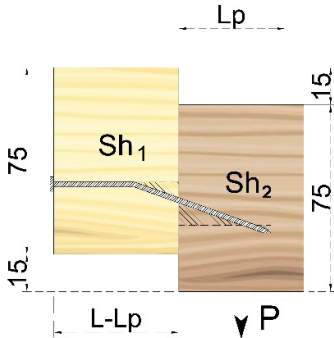
Details of Specimen			Maximum Load (N)
Specimens Type	Cross-Section (mm)		
S-R	SR-N-1	41 × 81	1627.66
	SR-N-2	36 × 60	1292.19
	SR-N-3	31 × 64	1071.88
	SR-N-4	35 × 66	1324.52
	Mean value	36 × 68	1329.06
	SR-S-1	30 × 69	1593.75
	SR-S-2	30 × 70	1870.31
	SR-S-3	34 × 63	1954.69
	SR-S-4	34 × 61	1612.50
	Mean value	32 × 66	1757.81

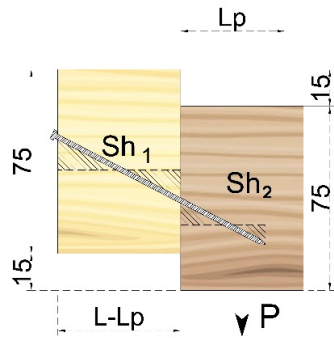
Table 7. Comparison of Yield Strength Determined by Different Yield Theories.

Specimen	Smith	Foschi		US 5%		
	Yield Strength (N)	Yield Strength (N)	Foschi/Smith	Yield Strength (N)	US 5%/Smith	
SS-N	1	424.43	548.83	1.29	473.32	1.12
	2	414.56	702.25	1.69	644.32	1.55
	3	424.43	680.15	1.60	637.28	1.50
	4	414.56	685.35	1.65	620.84	1.50
	Mean value	419.50	654.15	1.56	593.94	1.42
RR-N	1	1211.29	1790.93	1.48	1743.60	1.44
	2	1021.29	1587.56	1.55	1511.60	1.48
	3	1235.04	1803.79	1.46	1597.90	1.29
	4	1068.79	1710.34	1.60	1505.76	1.41
	Mean value	1134.10	1723.16	1.52	1589.72	1.40
SR-N	1	689.24	1483.36	2.15	1192.33	1.73
	2	605.18	790.57	1.31	606.17	1.00
	3	521.13	530.28	1.02	473.56	0.91
	4	588.37	890.91	1.51	725.59	1.23
	Mean value	600.98	923.78	1.54	749.41	1.25
SS-S	1	468.30	729.84	1.56	572.09	1.22
	2	404.44	641.16	1.59	575.99	1.42
	3	478.95	785.69	1.64	525.99	1.10
	4	532.16	1062.33	2.00	928.74	1.75
	Mean value	470.96	804.76	1.71	650.70	1.38
RR-S	1	1024.42	1758.64	1.72	1666.89	1.63
	2	1101.25	1845.10	1.68	1512.96	1.37
	3	1024.42	1526.10	1.49	1420.53	1.39
	4	1203.69	1855.80	1.54	1575.48	1.31
	Mean value	1088.45	1746.41	1.60	1543.97	1.42
SR-S	1	815.71	890.45	1.09	881.54	1.08
	2	815.71	1184.32	1.45	1075	1.32
	3	743.20	1067.33	1.44	917.85	1.23
	4	743.20	1150.86	1.55	990.95	1.33
	Mean value	779.46	1073.24	1.38	966.34	1.24

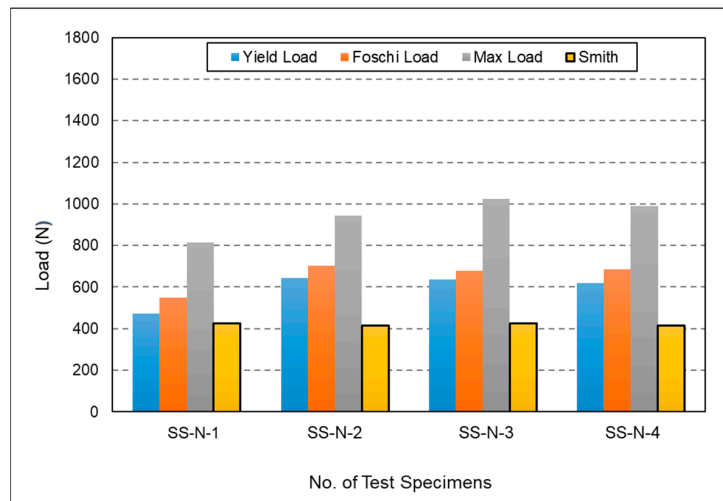

Figure 18. Yield strength of type SS-N fastened by nail.

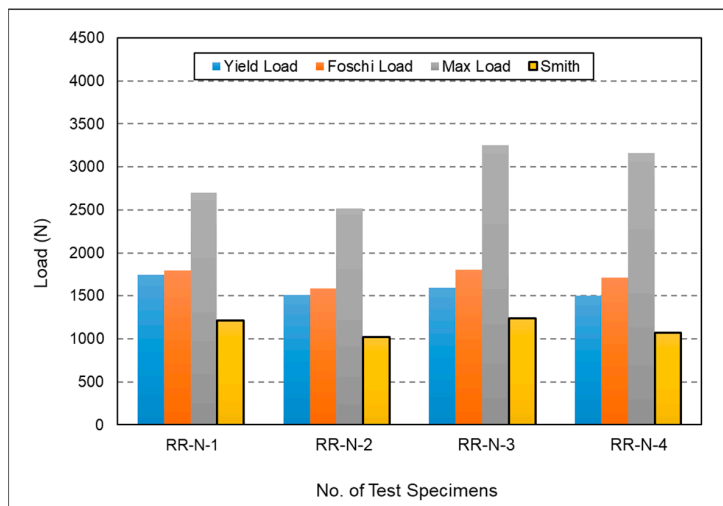

Figure 19. Yield strength of type RR-N fastened by nail.

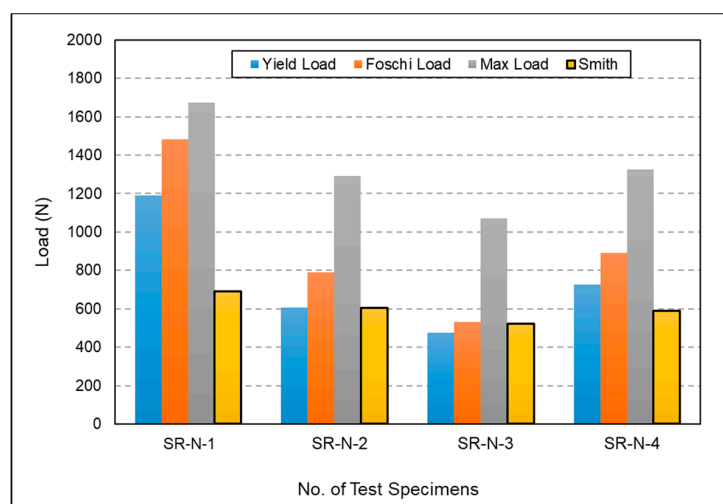

Figure 20. Yield strength of type SR-N fastened by nail.

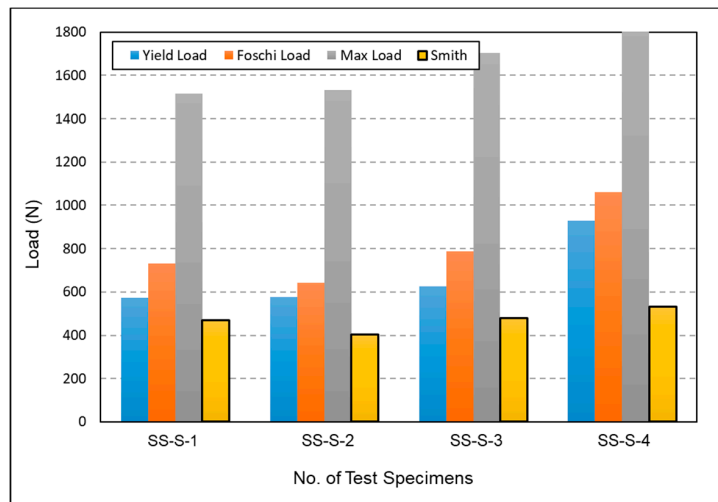

Figure 21. Yield strength of type SS-S fastened by screw.

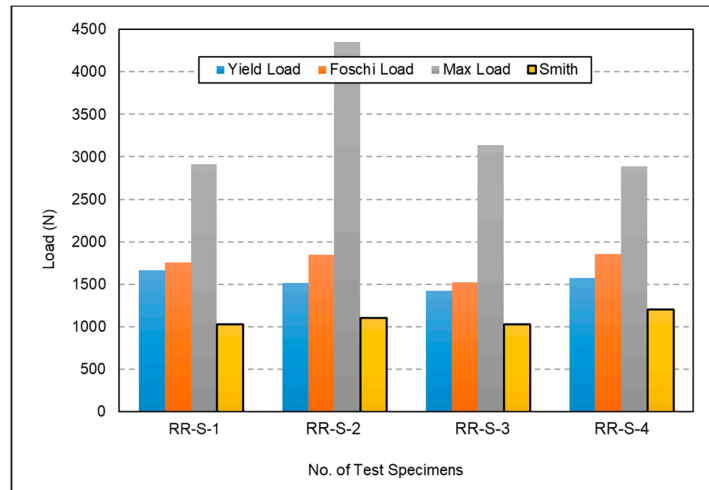

Figure 22. Yield strength of type RR-S fastened by screw.

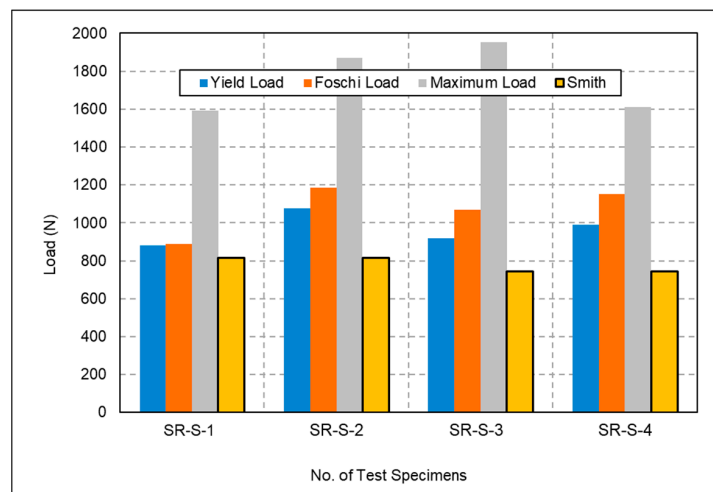

Figure 23. Yield strength of type SR-S fastened by screw.

5. Discussion

5.1. Efficiency of Fasteners

The major failure modes for specimen S–S were crushing of the Sh1 and Sh2 due to the low density of the Silkwood. When the specimens were fastened by self-tapping screws, the fasteners bent and the Sh2 was crushed. The major failure mode that occurred in specimen R–R was bent fasteners. Two failure modes occurred in specimen S–R (combined Silkwood and Indonesian Rosewood). In one test, the steel nails bent and were crushed in the Silkwood. In the second failure mode, no changes were observed in the fasteners, but major damage occurred to the Silkwood. Regarding the combinations of Indonesian Rosewood, the shear load values derived for combinations with steel nail fasteners and combinations with self-tapping screw fasteners were close; both had some of the highest shear loads, which were approximately 1.7 times higher than combinations of Silkwood with self-tapping screw fasteners. Considering the influence of applying different fasteners, the maximum shear load of combinations of Silkwood with self-tapping screw fasteners was approximately 75% higher than that of combinations with steel nail fasteners, indicating the importance of the fasteners. From the observation of the failure modes, it is also understood that with the increasing of the wooden density, the shear strength that is influenced by the wooden property declines. Thus, the shear resistance is majorly influenced by the bending strength of the fastener.

5.2. Accuracy of Predicted Yield Strength

Three yield theories were applied in this study. The predicted yield strength by Smith yield load theory was compared with the yield strength that was obtained from the experiments and determined by Foschi yield load theory and U.S. 5% offset yield load theory. Based on the comparison of mean values, as shown in Table 7, the yield strength determined by the experiment was always higher than the predicted values by 1.38 to 1.71 times, demonstrating that the predicted yield strength can be estimated in a conservative manner. The properties of waste wood vary depending the local condition; the conservative prediction of the yield strength ensures the satisfactory safety factor of the design.

5.3. Estimation of Cost

The cost estimation was made in order to compare the cost difference between applying waste-wood composite and solid wood. According to the local market, the price of solid wood were USD\$2300/m³ for Indonesian Rosewood, and USD\$37–USD\$66.6/m³ for Silk Tree depending on the quality. The price of waste wood was USD\$180–USD\$400/m³ and USD\$1.85–USD\$3.7/m³ depending on the size for Indonesian Rosewood and Silk Tree, respectively. The labor cost was determined by the volume of the wood product that was prefabricated, which were USD\$26/m³ and USD\$14.8/m³ for Indonesian Rosewood and Silk Tree, respectively. For the fasteners, every 100 nails or 100 screws cost USD\$1.25 or USD\$1.26, respectively. Considering the fabrication of a structure component with a cross-section of 0.1 m × 0.1 m that was 3 m long, the cost estimation and comparison between solid wood and waste wood were summarized in Table 8. It was obvious that the difference of the price between the solid wood structure and the waste-wood composite structure were great, approximately four times (USD\$ 78.8), when Indonesian Rosewood was used and prefabricated. The difference of the price between when Silk Tree was prefabricated and used were small (USD\$0.90). The cost estimation indicated that the development of the waste-wood composite structure was potentially valuable. The price was competitive and affordable for the local people, even when using high quality Indonesian Rosewood. The efficient utilization of waste wood help enhancing the sustainable recycle of wooden market as well.

Table 8. Cost Estimation (USD\$) and Comparison with Structure Size of 0.1 m × 0.1 m × 3 m.

Type of Composite	Cost of Wood		(3) Cost of Fasteners		(4) Cost of Labor	Total Price (USD\$)	
	(1) Solid	(2) Waste	Nails	Screws		Solid (1) + (4)	Waste (2) + (3) + (4)
Type S–S	2.1	0.2			0.64	2.74	1.84
Type R–R	96.6	16.8	1.0	1.0	1.12	97.72	18.92
Type S–R	-	8.7			1.12	-	10.82

6. Conclusions

The waste-wood composite structure was proposed in this study by applying the usage of the waste wood, the efficiency of wood recycling, and the increased value of cascading utilization (CU) can be achieved, making the proposed composite structure a sustainable solutions for local people in Indonesia. The cost-efficient waste-wood composite provides local people an alternative solution to concrete that is affordable, eco-friendly and sustainable, for the construction of the traditional house. It is also expected to improve the sustainability of the forest–wood chain, and potentially mitigate climate change by the efficient use of the wood product.

According to the preliminary testing and examination of the feasibility of the waste-wood composite structure, although the number of tested specimens were small, due to the consideration of variability on the geometry, the representative testing results may not be concluded and can be only limited to the tested specimens specifically in this study. However, the results that were obtained in this study examined the feasibility of the assembling of the waste wood in Indonesia, and it may provide an outline for the future application and references for the application of these waste-wood composite structures. Further study including the variation of geometry, the dependence on the contact surface between elements, and detailed information related to the embedment strength of the wood, screw withdraw capacity, and so on need to be considered and carried out. Meanwhile, the cost estimation and comparison between the solid wood structure and waste-wood composite structure indicated that the price of the waste-wood composite structure was potentially competitive and affordable for the local people, which was optimistic for further development. Hence, application of the waste-wood composite structure is considered valuable, and full-scale experiments are expected to be carried out based on the results obtained in this study.

Author Contributions: M.-T.T. conceived and designed the experiments; A.S.W. performed the experiments and analyzed the data; M.-T.T. contributed reagents/materials/analysis tools; M.-T.T. and A.S.W. wrote the paper.

Acknowledgments: This research is financially supported by National Taiwan University of Science and Technology.

Conflicts of Interest: The authors declare no conflict of interest.

References

1. Dawson, B.; Gillow, J. *The Traditional Architecture of Indonesia*; Thames and Hudson Ltd.: London, UK, 1994; pp. 109–146.
2. Brunet-Navarro, P.; Jochheim, H.; Muys, B. Modelling carbon stocks and fluxes in the wood product sector: A comparative review. *Glob. Chang. Biol.* **2016**, *22*, 2555–2569. [[CrossRef](#)] [[PubMed](#)]
3. Wolfslehner, B.; Huber, P.; Lexer, M.J. Smart use of small-diameter hardwood—A forestry-wood chain sustainability impact assessment in Austria. *Scand. J. For. Res.* **2013**, *28*, 184–192. [[CrossRef](#)]
4. Tsai, M.T. Field Investigation of Retrofitting and Adaptive Reuse of Historic Wooden Buildings in Taiwan. *J. Asian Archit. Build. Eng.* **2017**, *16*, 387–394. [[CrossRef](#)]
5. Claudia Mair, C.; Stern, T. Cascading Utilization of Wood: A Matter of Circular Economy? *Curr. For. Rep.* **2017**, *3*, 281–295.
6. Mantau, U. Wood flow analysis: Quantification of resource potentials, cascades and carbon effects. *Biomass Bioenergy* **2015**, *79*, 28–38. [[CrossRef](#)]

7. Parobek, J.; Paluš, H.; Kaputa, V.; Šupín, M. Analysis of wood flows in Slovakia. *BioResources* **2014**, *9*, 6453–6462. [[CrossRef](#)]
8. Sommerhuber, P.F.; Wenker, J.L.; Rüter, S.; Krause, A. Life cycle assessment of wood-plastic composites: Analysing alternative materials and identifying an environmental sound end-of-life option. *Resour. Conserv. Recycl.* **2017**, *117*, 235–248. [[CrossRef](#)]
9. Ramage, M.; Burrige, H.; Busse-Wicher, M.; Fereday, G.; Reynolds, T.; Shah, D.; Wu, G.; Yu, L.; Fleming, P.; Densley-Tingley, D.; et al. The wood from the trees: The use of timber in construction. *Renew. Sustain. Energy Rev.* **2017**, *68*, 333–359. [[CrossRef](#)]
10. Leichti, R.J.; Falk, R.H.; Laufenberg, T.L. Prefabricated wood composite I-beams: A literature review. *Wood Fiber Sci.* **1990**, *22*, 62–79.
11. Tsai, M.-T.; Le, T.D.H. Determination of Initial Stiffness of Timber–Steel Composite (TSC) Beams Based on Experiment and Simulation Modeling. *Sustainability* **2018**, *10*, 1220. [[CrossRef](#)]
12. Meghlat, E.-M.; Oudjene, M.; Ait-Aider, H.; Batoz, J.-L. A new approach to model nailed and screwed timber joints using the finite element method. *Constr. Build. Mater.* **2013**, *41*, 263–269. [[CrossRef](#)]
13. Heine, C.P.; Dolun, J.D. A New Model to Predict the Load-Slip Relationship of Bolted Connections in Timber. *Wood Fiber Sci.* **2001**, *13*, 535–549.
14. Leško, A. Modern Moment Resisting Timber Connections—Theory and Numerical Modelling. *Procedia Eng.* **2016**, *153*, 400–406. [[CrossRef](#)]
15. IPQuenneville, S. Predicting capacities of joints with laterally loaded nails. In Proceedings of the 32nd Meeting, International Council for Research and Innovation in Building and Construction, Working Commission W18-Timber Structures (CIB-W18), Graz, Austria, 23–25 August 1999.
16. Foschi, R.O. Load-Slip characteristic of nails. *Wood Sci.* **1974**, *7*, 69–76.
17. Jumaat, M.Z.; Murty, B. The relationship between yield load point using Foschi plastic theory and maximum load on Malaysian timber nail joints. In Proceedings of the 7th World Conference on Timber Engineering, Shah Alam, Malaysia, 12–15 August 2002.
18. Rammer, D.R.; Zelinka, S.L. Withdrawal Strength and Bending Yield Strength of Stainless Steel Nails. *J. Struct. Eng.* **2014**, *141*, 04014134. [[CrossRef](#)]
19. Said, A.A. *Simbolisme unsur Visual Rumah Tradisional Toraja dan Perubahan Aplikasinya Pada Desain Modern*; Ombak: Yogyakarta, Indonesia, 2004; pp. 47–83.
20. Soltis, L.A.; Hanson, S. Strength of Light-Gauge Steel Nailed Connections. *For. Prod. J.* **1991**, *41*, 57–60.
21. Aytikin, A. Determination of Screw and Nail Withdrawal Resistance of Some Important Wood Species. *Int. J. Mol. Sci.* **2008**, *9*, 626–637. [[CrossRef](#)] [[PubMed](#)]
22. Jumaat, M.Z.; Murty, B. Yield load prediction of nailed timber joints using nail diameter and timber specific gravity. *Wood Sci. Technol.* **2004**, *38*, 599–615. [[CrossRef](#)]
23. Solarino, F.; Giresini, L.; Chang, W.; Huang, H. Experimental Tests on a Dowel-Type Timber Connection and Validation of Numerical Models. *Buildings* **2017**, *7*, 116. [[CrossRef](#)]
24. Celebi, G.; Kilic, M. Nail and screw withdrawal strength of laminated veneer lumber made up hardwood and softwood layers. *Constr. Build. Mater.* **2007**, *21*, 894–900. [[CrossRef](#)]
25. Hansen, K.F. Mechanical properties of self-tapping screws and nails in wood. *Can. J. Civ. Eng.* **2002**, *29*, 725–733. [[CrossRef](#)]
26. Lathuillière, D.; Bléron, L.; Descamps, T.; Bocquet, J.-F. Reinforcement of dowel type connections. *Constr. Build. Mater.* **2015**, *97*, 48–54. [[CrossRef](#)]
27. Chui, Y.H.; Chun, N. Performance of wood joints fastened with power driven nails. In Proceedings of the 6th World Conference on Timber Engineering, Whistler Resort, BC, Canada, 31 July–3 August 2000.

