

## Article

# The Quality Control System of Green Composite Wind Turbine Blade Supply Chain Based on Blockchain Technology

Hang Yu \*, Senlai Zhu \* and Jie Yang

School of Transportation and Civil Engineering, Nantong University, Se Yuan Road #9, Nantong 226019, China; Turtlesky@126.com

\* Correspondence: yuhang@ntu.edu.cn (H.Y.); zhusenlai@ntu.edu.cn (S.Z.)

**Abstract:** Nowadays, blockchain technology is expected to promote the quality control of traditional industry due to its traceability, transparency and non-tampering characteristics. Although blockchain could offer the traditional industry new energy, there are still some predictable difficulties in the early stage of its application, such as the structure of the blockchain-based system, the role of regulators in the system and high transaction fee by block packing. In this paper, we establish a pioneering quality control system for the green composite wind turbine blade supply chain based on blockchain technology. Firstly, the framework of this system is proposed to ensure that the quality of the product could not only be examined and verified by regulator, but also be monitored by other related nodes. Next, we develop a new way to store the data by hash fingerprint and the cost of transaction fees is significantly reduced in the case of a large amount of data. Then, the information on-chain method is developed to realize the data traceability of each node. At last, the tests of this system are carried out to prove its validity, the satisfactory results are obtained and information supervision and sharing role of the regulators are discussed.



**Citation:** Yu, H.; Zhu, S.; Yang, J. The Quality Control System of Green Composite Wind Turbine Blade Supply Chain Based on Blockchain Technology. *Sustainability* **2021**, *13*, 8331. <https://doi.org/10.3390/su13158331>

Academic Editor: Cheolho Yoon

Received: 19 May 2021  
Accepted: 20 July 2021  
Published: 26 July 2021

**Publisher's Note:** MDPI stays neutral with regard to jurisdictional claims in published maps and institutional affiliations.



**Copyright:** © 2021 by the authors. Licensee MDPI, Basel, Switzerland. This article is an open access article distributed under the terms and conditions of the Creative Commons Attribution (CC BY) license (<https://creativecommons.org/licenses/by/4.0/>).

**Keywords:** blockchain; green composite; wind turbine blade; quality control; supply chain

## 1. Introduction

The improvement of environmental protection consciousness and the promulgation of the related regulations have promoted the rapid development of new energy industries [1,2]. Wind energy is a kind of renewable energy that provides a way to solve the global resource shortage and environmental problems. The collection efficiency of wind energy is largely determined by the aerodynamic shape, the length of the blades and the materials used to manufacture the blades [3]. Most of the glass fiber reinforced plastics (GFRP) and carbon fiber reinforced plastics (CFRP) have been used to produce blades of large wind turbines, but the use of these non-biodegradable materials will also cause lots of environmental problems [4,5]. Compared with the traditional synthetic fibers, natural fibers have the advantages of low density, low price, degradability, high specific modulus and specific strength; the use of bio-composite is becoming the new trend in wind energy industry [6,7].

The design life of the blade is generally 20 years, the quality control in each supply chain is particularly critical to ensure that the blades do not have major quality problems in such a long time. The work of wind turbine significantly relies on the quality of blade, which should be carefully controlled from raw material to final product in the supply chain. Figure 1 shows the key nodes in the traditional supply chain of wind turbine blades, the quality problems of blades are generally concentrated in raw material node, prepreg node, manufacturer node, transport node and final product [8]. The quality of raw material is the basis of normal operation of blades, the poor quality of raw material can cause damage in the internal structure by mechanical vibration [9]. The natural fibers have a strong hydrophilicity, which makes it necessary to pretreat the natural fibers before manufacturing the prepreg to reduce the water absorption. The mechanical properties and water resistance of prepreg can directly affect the performance of the final product in

hydrothermal environment [10]. The manufacturer node involves more complex human operation, which will cause many quality-related problems. For example, the operation proficiency of worker has great fluctuation on the uniformity of product quality. The uneven glue content and incomplete material curing in the manufacturing process will cause blade deformation, crack and fracture [11]. Additionally, it has been found that many blade damages are caused by the transportation process. Due to the excessive deformation, collision and vibration, the micro cracks emerge and are likely to be imperceptible. Although the appearance defects of blades do not affect the product in the early stage, the blade defects will gradually develop into serious quality problems in the final product node, such as cracks, paint removal, aging and even fracture after a long period under vibration, fatigue and wind conditions [12].

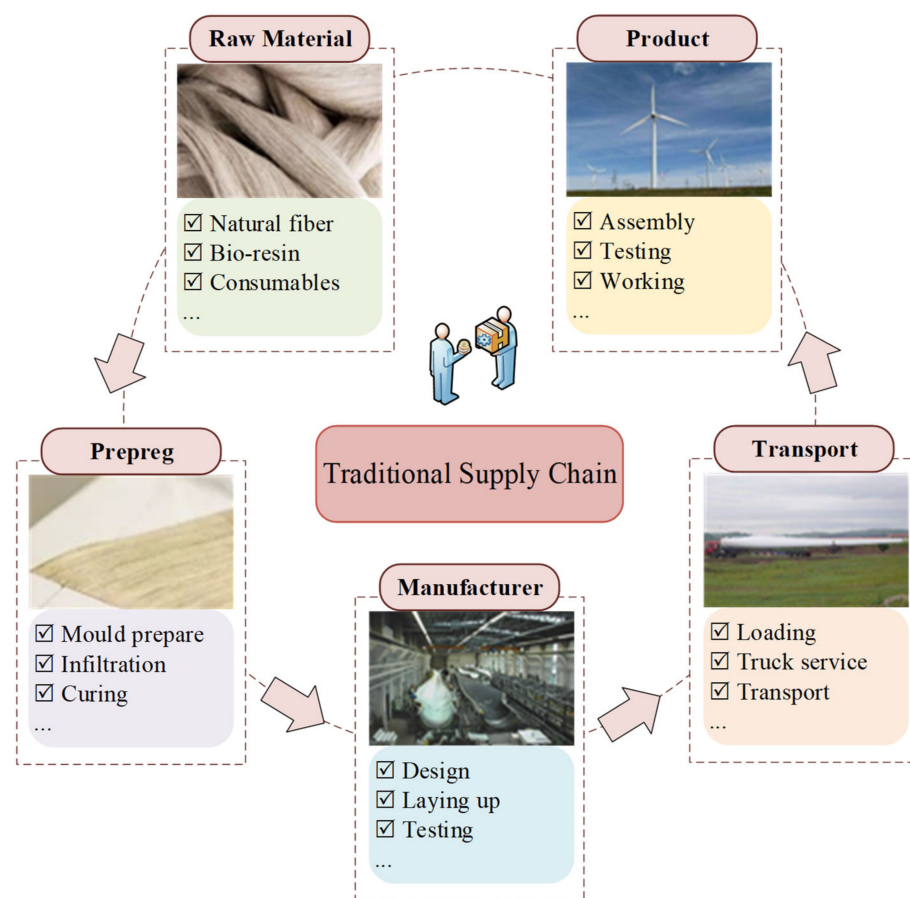

**Figure 1.** Traditional wind turbine blade product supply chain.

The traditional quality control system of the wind turbine blade supply chain are generally centralized approaches. For example, Kumar [13] proposed a knowledge management-based analytical hierarchy process (AHP) to collect supply chain information; this system can help customers to identify the right suppliers and ensure the balance between cost, quality, transport and stability. Yuan et al. [14] investigated the supply chain of wind power in China, and the supply information showed that the related policies will help understand the progress and challenges to wind energy industry. Traditional centralized methods make it difficult for each node to know all transaction information and origins of the products [15]. In recent years, the increasing use of blockchain can be a better solution to control the quality problems and change future operations of new energy fields [16,17]. Blockchain is a kind of distributed digital ledger, which can record transactions of multiple block series [18]. It is a decentralized system that does not rely on a single entity for safe custody to ensure security [19]. Blockchain brings new hope for the quality control system

because of its traceable, transparent and tamper-proof characteristics, which can ensure the nodes involving stakeholders in the traceable value chain from the raw materials to the final product [20]. The following Figure 2 is given to summarize the existing problems and challenges.

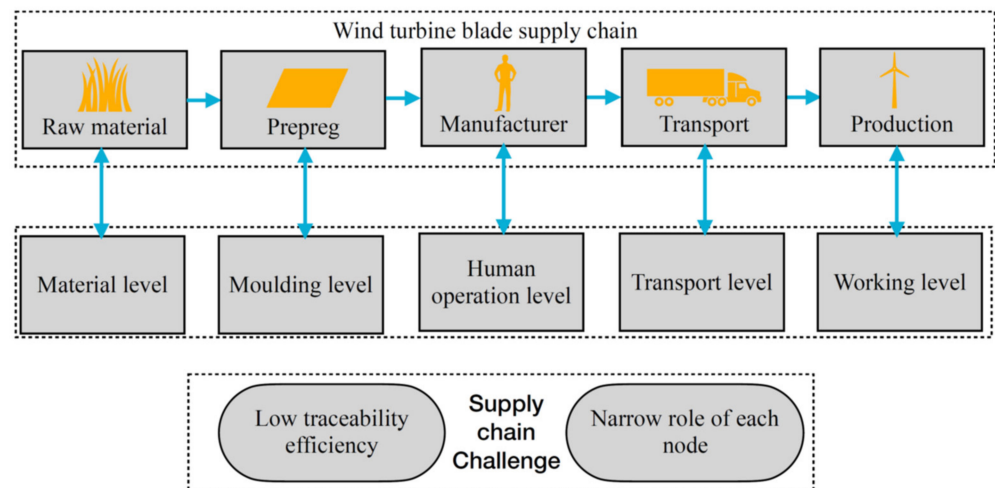

**Figure 2.** The problems and challenges of the wind turbine supply chain.

In the literature review, the supply chain can benefit from the use of blockchain technology in various aspects. For example, the supply chain should be more sustainable to increase the trust of the consumers, and tracking the information from the whole supply chain is a significant approach to address and identify sources of quality problems [21]; however, the traditional way may allow the information to be tampered with and the transparency cannot be guaranteed. When the data are stored in a blockchain, the information cannot be modified, resulting in the non-tampering characteristic of blockchain [22]. The use of blockchain technology can not only ensure the traceability and transparency of these information, but also be a potential solution to the privacy of individual and company, using public and private key encryption techniques to control their information [23].

To the authors' knowledge, many existing blockchain supply chain system solutions remain in the early stage. Although blockchain technology has many advantages, there are still some problems with using this technology in wind turbine blade supply chain, such as the position of regulators, the high cost of storing a large amount of data and the construction of a supply chain platform in the wind energy industry. Therefore, we propose a novel blockchain system in this paper to improve the quality control of the key nodes in the supply chain. This new system develops the coordination between the regulator node and other nodes to ensure the traceability, transparency and prevention of data tampering, making the control of each node more efficient. We also provide a fingerprint on-chain method to reduce the packing charge when the data are too large. The smartphone platform is finally given to conveniently manage the information by users, and the results are given to prove the feasibility of the system.

The main contributions of this paper are given as below:

- The main aim of this paper is to develop the quality control system of a green composite wind turbine blade supply chain, since few efforts have been carried out to establish this system.
- The proposed system can realize the traceability of the green composite wind turbine blade supply chain, and the data on-chain method and trace process are illustrated in the paper. The quality of the product could not only be examined and verified by regulator, but also be monitored by other related nodes.
- We develop a new way to store the data by hash fingerprint and the cost of transaction fee of Ethereum is significantly reduced in the case of a large amount of data.

- The existing supply chain system has not improved the role of regulators; thus, the sharing and monitoring roles of the regulators are discussed in proposed system.

The paper is organized as follows. A brief overview of the related work is presented in Section 2. Section 3 proposes the wind turbine blade supply chain system and explains the information on-chain process. Section 4 shows the test results of an on-chain program and the role of regulator node. Finally, the main conclusions and future works are discussed in Section 5.

## 2. Literature Review

This section contains the details about the blockchain technology used in supply chain and some recent blockchain research overview.

### 2.1. Blockchain Working Principle

Blockchain is known as a distributed ledger by using a lot of novel technologies which can be used to share digital data [24]. Blockchain is composed of a linked block sequence to store the transaction, which uses a public key password and verification of the network community to protect the time stamped transaction [25]. When the data are stored in a blockchain, the information cannot be modified, resulting in the un-tamperability of blockchain [26]. The long time application of blockchain requires less money, and can employ real information for companies and consumers, which could be traced from raw material to final product. Blockchain is a significant technology, since it can reduce the time of the transaction from days to instantaneously, save costs, prevent cyber crime and increase the security of the record. The details of blockchain technology are shown below:

- (1) Consensus Mechanism: The consistency and integrity in blockchain is provided by consensus protocol, and the transactions are assured across the distributed nodes [27]. Pow is one of the typical existing consensus protocols, which was developed to realize Bitcoin transactions, and nearly 47.1 terawatts/hour of energy will be consumed every year [28]. The disadvantage of this consensus mechanism is its high energy consumption, which reduces the application of the system in many situations. Thus, new consensus protocols have been proposed to deal with this problem, such as Proof of Stake (PoS) and Practical Byzantine Fault Tolerance (PBFT) [29]. The energy consumption is reduced by some consensus protocols, while some of these consume more energy. In this paper, the information on-chain operation is realized by using Ethereum, which is the most popular platform for smart contracts [30]. Two types of accounts are supported by Ethereum, the user-controlled account and the contract account, and both of them can store the Ethereum currency, ether [31]. The contract account must be activated by user-controlled account, and executing functions requires the user-controlled account to pay for gas using the ether currency. The price of gas can determine the conversion rate of gas to ether. The gas which is similar to the transaction fee will reward miners to include transactions in blocks. The miner who successfully concludes the transactions is rewarded five ethers [32].
- (2) Privacy Mechanism: The private key and public key encryption are important technologies of the blockchain system, and have been used for information and data security [33]. The researchers now have found that blockchain technology is a very useful solution to the privacy demand through decentralizing data and information in many fields, such as IoT networks, supply chain and medical networks [34]. Everyone can participate and the transactions in Bitcoin blockchain since it is publicly available. The private or public blockchain has to be related to the ledger and participation. Private blockchain determines who can participate, offering the power to one company or person, which will hurt the trust between people [35]. The public blockchain may give better participation to the public. The advantage of private key and public key encryption technologies is that we could select the type of the blockchain to fit the need, so as to face the cyber risk problem of different communities [36].

## 2.2. Blockchain Technology in Supply Chain

In the supply chain, blockchain can protect the visibility by capturing information from different nodes, including raw material, intermediate products, transportation and end product [37]. The overhead and agency costs of companies can be reduced and the tampering and fraud can be decreased through increasing trust using shared processes and records. Blockchain technology can effectively help the retailers recall specific suspected products rather than the entire product line [38]. The typical nodes in the supply chain are listed in Figure 1. In fact, there should be more nodes in the supply chain of wind turbine blades, as the number of nodes could increase on the basis of the actual needs. Blockchain provides the following services to the supply chain:

- (1) Un-tamperability. The supervising engineer shall carefully review the production qualification, equipment status and other relevant information of blade manufacturers. Once the data are stored on the blockchain, it cannot be not tampered, which can prevent the enterprises from tampering or destroying data adverse to them [39].
- (2) Data transparency and privacy protection. Blockchain technology can not only realize the un-tamperability of data on-chain, but also protect the privacy of individuals that must be hidden. It can also control the data that enterprises want to share, give the relevant quality supervision department higher viewing authority and realize the acceleration of transaction speed and quality improvement on the supply chain [40].
- (3) Traceability of quality problems. During the manufacturing process of blades, the supervising engineer shall carefully complete the inspection and upload the data at the preset quality witness place [41]. For example, some specific parameters should be recorded in the manufacturing process, such as temperature, time, mechanical properties, etc. Before transporting the blades, the supervising engineer shall review the transportation scheme, transportation mode and transportation conditions, etc. The important node information in many nodes of the supply chain can be stored on-chain, which can facilitate the query and trace the problems in the operation of turbine blades, so as to improve the quality of each node in the supply chain.

In the supply chain, blockchain can protect the visibility by capturing information from different nodes, including raw material. Table 1 shows the critical analysis of the blockchain technology used in supply chain.

**Table 1.** Critical analysis of the blockchain technology used in supply chain.

References	Year	Objective	Merits	Demerits
[42]	2019	Realize the traceability of electronics supply chain	Track and trace every chip while they are circulating	Lacks in showing the system results
[43]	2020	Overcome counterfeit medications in the community	Better system performance was obtained	Lacks in explanation for blockchain system
[44]	2021	Establish payment system in construction supply chain	Both blockchain and smart contract are used in the system	Implementation results are missing
[45]	2020	Privacy and security challenges for supply chain	Good case study and data analysis for the proposed model	System framework description is not enough
[46]	2018	Transparent price issues in supply chain management	Allows companies to track their trades in the system	Data analysis has not been addressed
[47]	2019	Risk avoidance and coordination of supply chain	Information sharing are realized	Lakes in blockchain background



Table 1. Cont.

References	Year	Objective	Merits	Demerits
[48]	2020	Blockchain combining big data problem	Provides fundamental insights into the adoption of blockchain	Few results are provided
[37]	2018	Explore blockchain system in composite supply chain	Good supply chain description	No actual system performance is shown

To the authors' knowledge, the green composite product system based on blockchain technology which monitors the quality problem in the supply chain, the regulators' role in blockchain based system, reducing the transaction fees of the Ethereum method, have been seldom found in the literature. The conceptual framework provided in this paper can be an effective solution to the quality challenges of monitoring the important nodes in the green product supply chain and sharing the important data in this field.

### 3. The Blockchain-Based Wind Turbine Blade Supply Chain System

#### 3.1. The Blockchain-Based Conceptual Framework

To overcome the disadvantage of traditional supply chain in the wind turbine blade industry and encourage more companies and people to share their information and monitor the quality of the supply chain, the conceptual framework of the wind turbine blade supply chain is presented based on blockchain. Figure 3 shows the wind turbine blade product traceability system (WTBPS) for the supply chain of wind turbine blades. The application of blockchain technology can improve the quality control level and make the whole supply chain more reliable.

There are six key nodes in the conceptual framework, involving raw materials, prepreg, manufacturer, transport, product and regulator. Compared with the traditional supply chain, which cannot effectively share data, WTBPS can be the linkage of the different nodes to share, store and trace information.

The raw materials include natural fiber, bio-resin, consumables and other materials. Among the raw materials, flax fiber, hemp fiber and bio-resins are common green materials in the market. Prepreg is composed of resin matrix and reinforced fiber, which can be made by impregnating fiber or fabric with resin matrix. The manufacture process of wind turbine blades is relatively complex, including the overall and local design of blades, prepreg laying, glue brushing, curing, etc. Because the manufacturing process is highly dependent on technology, the quality of products of this node is directly determined by the manufacturing level of different manpower. The transport is also an important node to the supply chain of wind turbine blades, because the transport process will produce vibration and impact load on the material, which is likely to cause damage to the material. In the final stage, the blades and wind turbines will be assembled, debugged and formally put into operation.

The regulator node is responsible for supervising and verifying the quality of each node. For the traditional supply chain, the regulator can only monitor limited data, cannot effectively monitor the transparency of data and cannot better share the data. The proposed system in this paper can make it more convenient for the regulator to monitor the data of each node, and the data on the blockchain cannot be tampered; thus, this system can better improve the quality of supply chain.

The information stored on blockchain may cause high transaction fees when the data volume is too large; thus, the fingerprint (FP) form of the information is designed to deal with this situation in the on-chain process. The actual upload data are in the form of the original hash fingerprint information of the string data. Through the comparison of fingerprint information, we can ensure that the original information is correct and cannot be tampered. In this design, the fingerprint information is calculated by SHA256 + RIPEMD160, and we further discuss this method in the Section 3.3.

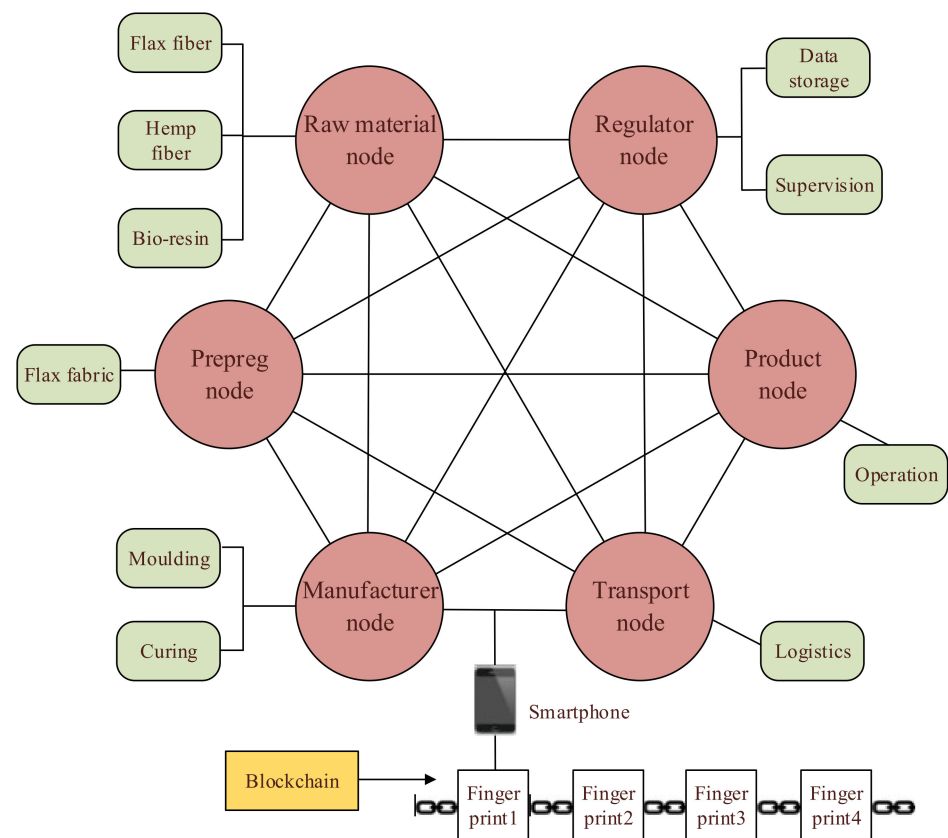

**Figure 3.** The framework of the blockchain network.

### 3.2. The Structure of the Wallet

The information on-chain process needs to create an asset wallet first, and we propose a new asset management wallet to realize this process more conveniently. This wallet has several accounts corresponding to a different public chain, and each account can have addresses which are the actual ID of each production node on-chain. This wallet relies on the software development kit (SDK) provided by the material on-chain project, and every node of the supply chain participates in the blockchain. The structure of the wallet is shown in Figure 4. The advantage of this wallet structure is that the material on-chain project can support the use of different digital currency accounts in a wallet, such as BTC (Bitcoin) and ETH (Ether) accounts. The generation of public keys do not need private keys so as to create better security and each account can use various addresses to satisfy different demands. If users want to work with this system, they only need to establish a new digital currency account and use this new digital currency as the main coin to complete transactions or data on-chain process. This wallet structure can be a useful tool since users can directly use the material on chain project provided by our group. Otherwise, users need to establish a new wallet structure by themselves.

In addition, compared with an HD wallet, the proposed wallet which is created by the material on chain project does not need to depend on a private key to produce public data. This design can effectively protect the security from the beginning.

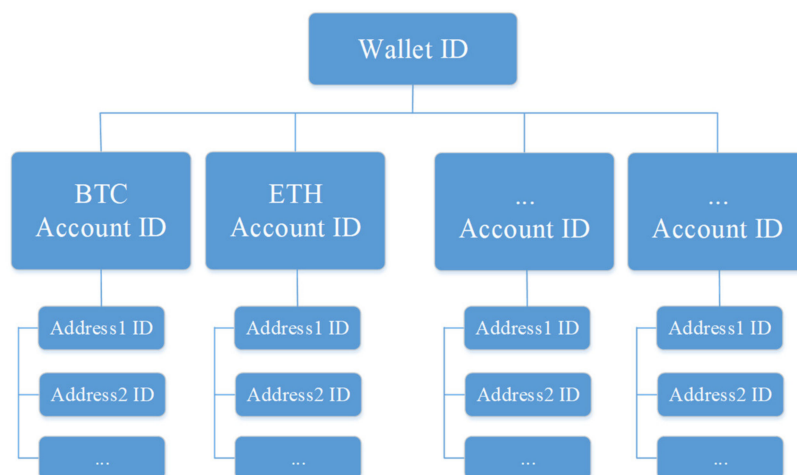

Figure 4. The structure of the wallet.

Through the wallet management interface defined in the blockchain operation, the construction of the wallet, the wallet ID, the account ID and address ID can be completed according to the process given in Figure 5. In step 1, we create the wallet ID via the create wallet function. In step 2, the wallet ID can further produce an account ID via the create account function. In step 3, the wallet ID and account ID can finally produce an address ID through the create address function.

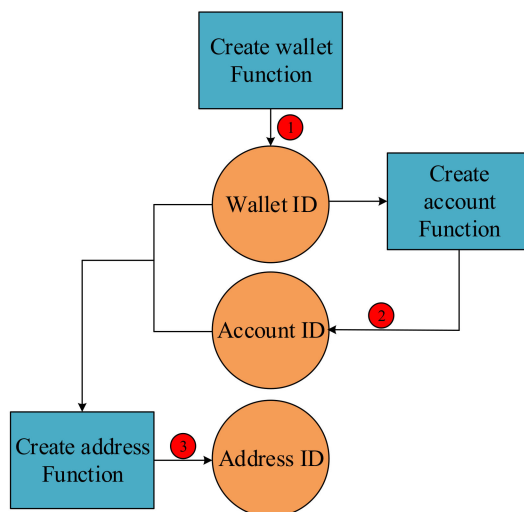

Figure 5. The creation of the information on-chain.

### 3.3. The Information On-Chain Method

To better illustrate the application of blockchain technology in WTBPS, the blockchain technology used in this system is shown in Figure 6. Through the SDK defined in blockchain, we establish the “create”, “sign” and “submit” process to complete the information on-chain operation. The information is inserted into the transaction in the “create” phase, and the corresponding private key is obtained through the wallet manager in the signature phase.

Taking the coordination between manufacturer node and regulator node as an example:

Step 1: the manufacturer generates its own public key and private key through the key manager, encrypts the product information and calculates the fingerprint information.



Step 2: the regulatory department is responsible for registering the manufacturer’s public key information, decrypting product information and calculating fingerprint information.

Step 3: the transaction information is created by the TX manager and verified with the manufacturer. After the verification is successful, the manufacturer merges the transaction information and fingerprint information through a signature operation, signs the transaction information and submits it to obtain TXID in the blockchain to complete the information on-chain operation.

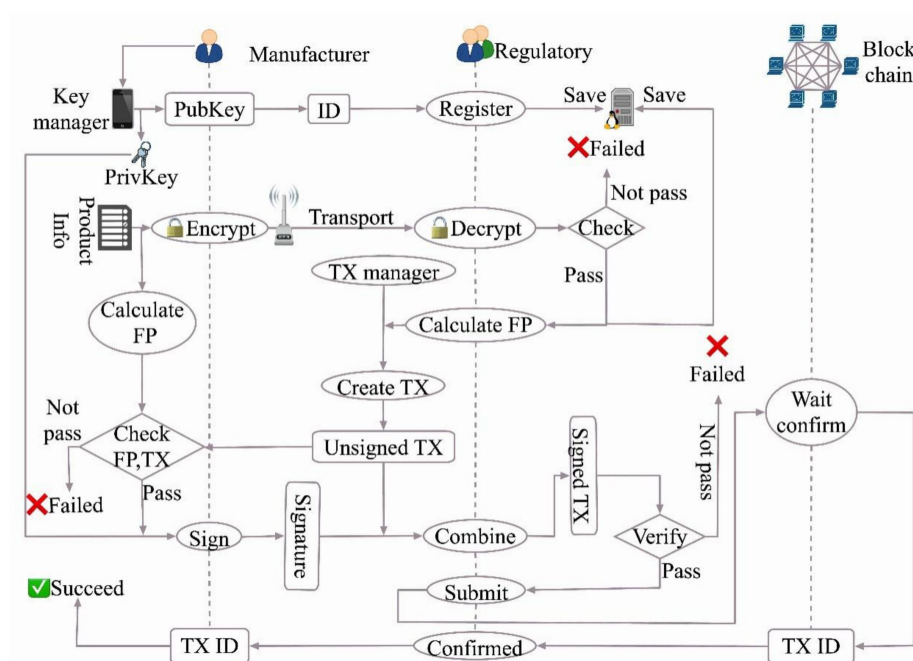

Figure 6. The data on-chain process.

### 4. Implementation

The key nodes of green composite wind turbine blade supply chain contain raw materials, prepreg, manufacturer, transport, product and regulator. An application of the above-mentioned blockchain-based system is as follows. First, the information on-chain process is given, including the wallet parameters and an example of flax fiber information in the raw material node on-chain process. Next, the role of the regulator node is explained to show the cooperation between different nodes. Lastly, the traceability of on-chain information is illustrated so as to better search and monitor the information of each node in the supply chain.

#### 4.1. The Information On-Chain Process

Taking ETH transaction as an example, we successfully obtain a group containing a wallet ID, account ID and address ID; the details are given in Table 2. The construction of the wallet is proved effective for creating specific address, and the use of this wallet manager can conveniently support further on-chain operations.

Table 2. An example of wallet ID, account ID and address ID.

Wallet Structure	ID
Wallet ID	WL2vQbcWwQZWg317x1kgegT6h1ox3oP86n
Account ID	2APXCoojgA5X1muGszsdsDX6MiDnbS26hYTiZXoaXW9E
Address1 ID	0x70dc632ec1fbb9d705ce79ead062a21570a5494
Address2 ID	0xc616eff28ec6020a78cb021a1f4d63183e7c0003

The application of the proposed system is tested to show its validity in mobile phones for the green composite wind turbine blade industry. For example, flax fiber information in raw material nodes is significant for the long term use of blades; the initial information of this node is shown in Table 3, and the information on-chain program and its application in mobile phones is given in Figure 7. In step 1, the flax fiber information is input into the smart phone. In step 2, this transaction, which contains flax fiber information, is created by a transfer function, and this information can be broadcast to the blockchain. In step 3, this transaction is verified and uploaded on the blockchain. Taking a wind turbine blade as an example, manufacturers can fill in the corresponding parameters through the on-chain function provided by a mobile phone, as shown in Figure 7b.

**Table 3.** Flax fiber information.

Flax Fiber Node	Information
Product	Flax fiber
Company	Chunlong
Manager contact information	86-3601-789656
Producing area	Jiangxi, China
Average length (mm)	18
Density (g/cm <sup>2</sup> )	1.5
Elastic modulus (GPa)	65
Tensile strength (GPa)	1.2

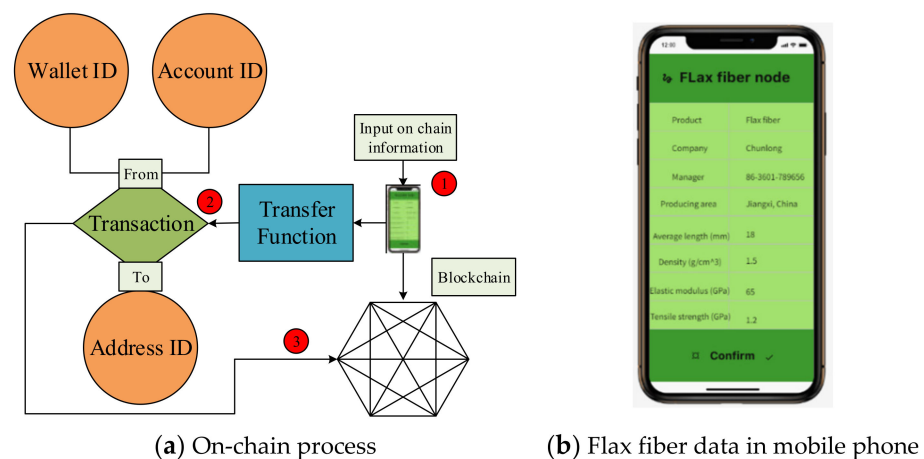

**Figure 7.** The application of the information on-chain.

These data record the key parameters of the product that users want to be saved. However, when the number of the uploaded characters is too large, in order to reduce the packing charges and protect the privacy of users, the actual upload data may not be in the form of the original Json string, but rather the hash fingerprint information of the string data. Through the comparison of fingerprint information, we can ensure that the original information is correct and cannot be tampered. In this design, the fingerprint information is calculated by SHA256 + RIPEMD160, and the final on-chain information can be modified as follows: ("company": "chunlong", "fingerprint": "cd3dcfe77508184e4da978755b51b2e23a5f87e3").

The number of characters and packing charges is shown in the Figure 8. It is seen that if the number of on-chain characters is 2000 characters, it is 3.1 times more expensive than 200 characters. However, the packing charge of the data in the hash fingerprint form is a constant USD 0.32, resulting in lower packing charges when the number of characters increases. When the number of characters becomes larger, this transaction fee will be more expensive. Thus, we can flexibly choose the on-chain way according to the needs to reduce the cost.

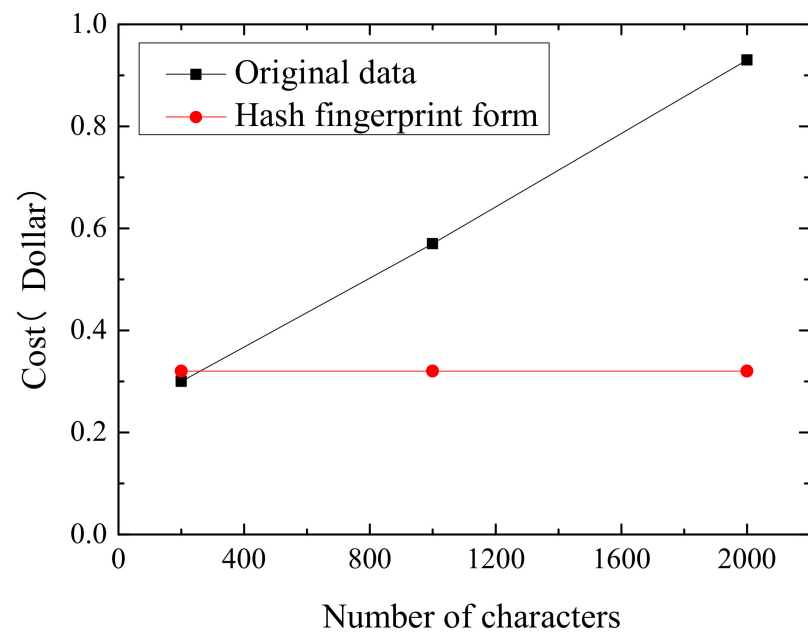

**Figure 8.** The number of characters and packing charges.

#### 4.2. The Cooperation between Regulator Node and Other Nodes

Figure 9 shows an example of product information on a chain system based on blockchain technology, and the cooperation between the regulator node and other nodes. Firstly, the regulator encrypts the fingerprint information on each node of the supply chain. Then, the information is stored in the blockchain after being put on-chain, including the product and TXID information, and the information is stored in the regulatory server. When the regulatory authorities or relevant institutions need to query this information, they can scan the QR code in the figure. If the relevant personnel does not have the authority to query these basic information, the system will end the operation and return “No”. If the user is qualified, the system will return “Yes”. Next, the user can acquire the TXID list from the blockchain through the blockchain scanner to read the fingerprint (FP) encryption information and compare it with the fingerprint of the product node information. If it is correct, all information on the products can be read successfully, and finally, the information traceability of the whole system will be completed. Otherwise, the system stops the operation and returns “No”.

The regulator node can effectively contact the manufacturer node, record the data of the node, control the information sharing and ensure the transparency of the data; thus, the efficiency of supervision has been improved. Additionally, this method can be used flexibly according to the content of the data that needs to be uploaded. When the data are short, they can be directly uploaded; when the data are large, the uploaded data can be transformed into a fingerprint first, which can reduce the cost of the block package. The specific application for smart phones is shown in Figure 10. The regulator can review the on-chain information in the form of TXID (Figure 10a) and the detail information (Figure 10b), then they can examine and decide whether the information should be passed and updated to the blockchain.

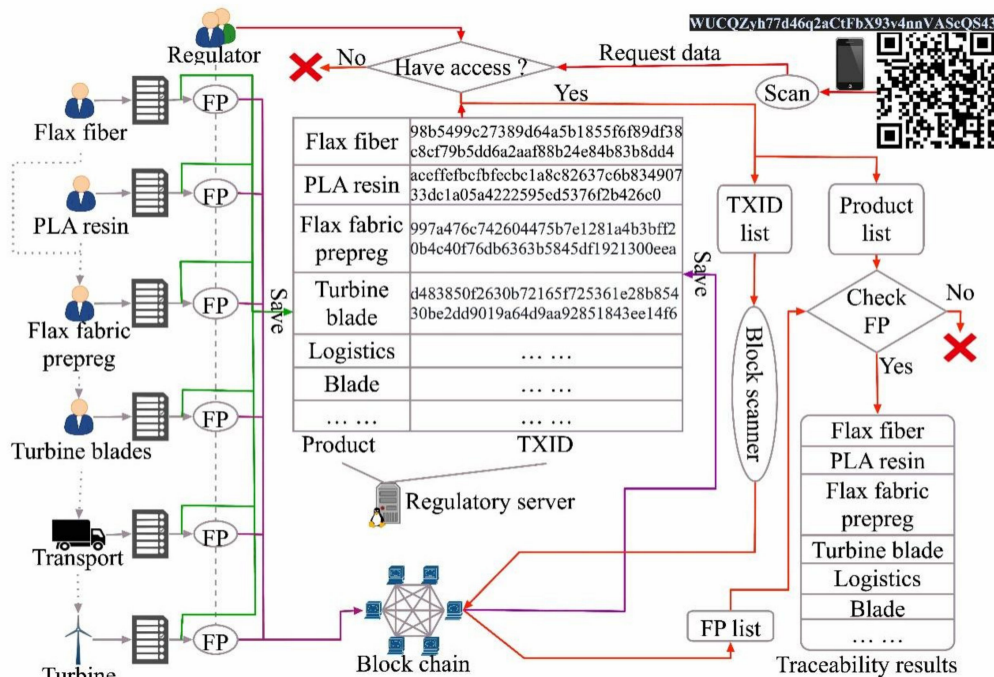

Figure 9. The example of the information online via the blockchain.

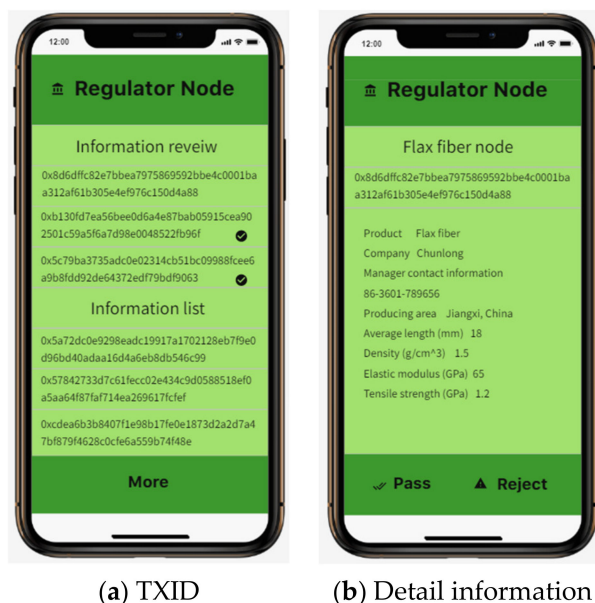
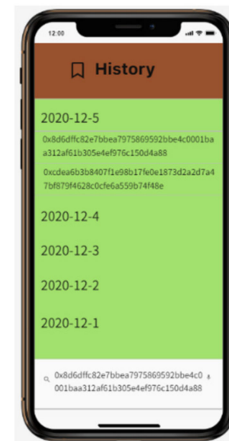
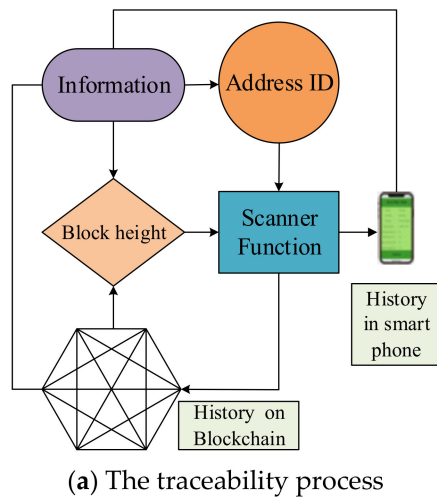

Figure 10. The regulator node in a smart phone.

4.3. The Traceability of the Information

The traceability process of information in the blockchain network is shown in Figure 10a. When we want to query the information, this program can query the historical records related to a transaction hash. If we want to find all history records at a special block height, we can use the scanner function and input the address ID and a certain block height to obtain all records, so as to achieve the purpose of traceability of supply chain information. Through the transaction hash, it is also convenient to query the relevant historical records in the Ethereum browser, and view the information on-chain. Taking the flax fiber node as an example, the operation results of smart phones and Ethereum are shown in Figure 11b–d. Figure 11b gives the interface of the history record in smart phone, where the results

are arranged by date. The Ethereum browser is also a good way to query the on-chain information; the detail is shown in Figure 11c. If we want to trace the history results, the block height is obtained by the Ethereum browser. The input flax fiber information on the Ethereum browser is also given in Figure 11d; once the data are uploaded to the blockchain, they cannot be tampered with.



(a) The traceability process (b) History record in smart phone

Transactions    Analytics    Comments

Latest 4 from a total of 4 transactions

Txn Hash	Block	Age	From	To
0x5c79ba3735adc0e02...	11436070	1 day 3 hrs ago	0xcb68e32fbd35e7c3b...	IN 0x70dc632ec1fbb9d70...
0xcdea6b3b8407f1e98...	11436049	1 day 3 hrs ago	0xcb68e32fbd35e7c3b...	IN 0x70dc632ec1fbb9d70...
0x8d6dff82e7bba797...	11436012	1 day 3 hrs ago	0xcb68e32fbd35e7c3b...	IN 0x70dc632ec1fbb9d70...
0x5a72dc0e9298eadc1...	11379425	9 days 20 hrs ago	0xcb68e32fbd35e7c3b...	IN 0x70dc632ec1fbb9d70...

(c) History records on Ethereum browser

Input Data:

```

0xProduct Flax fiber, Company Chunlong, Manager contact
information 86-3601-789656, Producing area Jiangxi, China,
Average length (mm) 18, Density (g/cm^3) 1.5, Elastic modulus
(GPa) 65, Tensile strength (GPa) 1.2
    
```

(d) Flax fiber information query on Ethereum browser

Figure 11. The traceability of on-chain information.

#### 4.4. Comparative Analysis

The performance of the proposed system is shown in Figures 12 and 13.

In Figure 12, the latency of an on-chain transaction of the system with three groups of participants as the average, minimum and maximum form is investigated. It is found that the average latency of 200 participants is 2728 ms, and when the number of participants increases to 400, the average latency is 2915 ms. However, if the participants increase to 800, the average latency will reach 3262 ms. In the case of 200, 400 and 800 participants, the minimum latency is 1620 ms, 1835 ms and 2168 ms, respectively, while the maximum latency is 3836 ms, 3995 ms and 4356 ms, respectively. The tendency of the on-chain transaction is that the latency increases with the increase in participants.

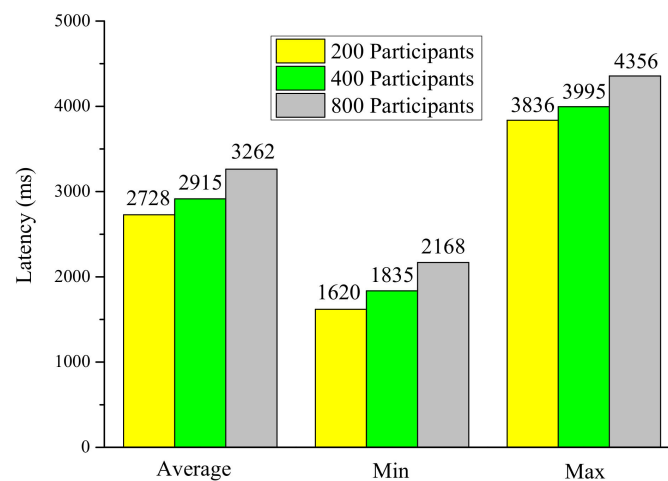

**Figure 12.** On-chain transaction latency.

In Figure 13, we present the traceability transaction latency when participants search the history records in the blockchain network. The latency of traceability transaction of the system with three groups of participants as the average, minimum and maximum form is investigated. We found that the average latency of 200 participants is 264 ms, and when the number of participants increases to 400, the average latency is 284 ms. If the participants increase to 800, the average latency will reach 299 ms. In the case of 200, 400 and 800 participants, the minimum latency is 78, 86 ms and 90 ms, respectively, while the maximum latency is 450 ms, 482 ms and 506 ms, respectively. From Figure 13, it is observed that the traceability transaction latency can be neglected with the increase in participants.

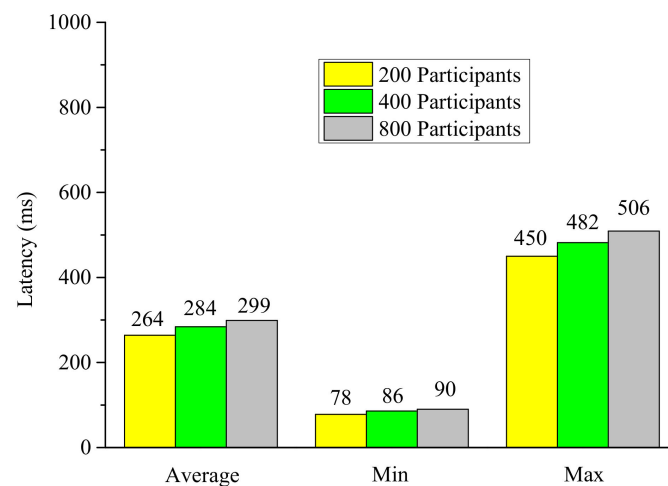

**Figure 13.** Traceability transaction latency.

The quality control system described in this paper is compared with other methods. Table 4 gives the results of this comparison. The detail analysis is shown below:

- (1) Traceability: the system proposed in this paper is a good example for traceability in a system, and the details are shown in the Section 4.3. However, the systems in some references cannot reach this function.
- (2) Regular role: the proposed system is based on blockchain, and the regulator node and other nodes all participate in the system, so they can easily join the system. As an early stage of blockchain application, the regulator role will be very confused, since decentralization is one of the most important advantages of blockchain technology, while regulators are also a significant power to make the supply chain more flexible and efficient. Thus, the blockchain-based system in this paper can make the



regulator node more useful. In comparison with other methods, some researchers have developed systems for the supply chain, but the regulator role in it is still very narrow.

- (3) Scalability: the proposed system in the wind turbine supply chain can further extend to more methods and smart contracts to improve the quality control of the whole supply chain.
- (4) Privacy: the proposed system in wind turbine supply chain can protect user privacy through blockchain's public and private key technology.
- (5) Implementation: the implementation and test results of the proposed system in are given in this paper.
- (6) Blockchain type: Ethereum is selected in this paper to realize on-chain data and the tracing process. It is noticed that the Hyperledger and Ethereum blockchain type can both realize the demand of the supply chain.

**Table 4.** Comparative analysis of blockchain systems for supply chain.

System	Traceability	Regulator Role	Scalability	Privacy	Implementation	Blockchain Type
[49]	×	×	✓	✓	✓	Hyperledger
[50]	✓	×	✓	✓	✓	Hyperledger
[51]	✓	×	×	✓	✓	Ethereum
[52]	✓	✓	×	✓	×	Ethereum
[53]	×	×	✓	×	×	Ethereum
This paper	✓	✓	✓	✓	✓	Ethereum

## 5. Conclusions

A traceability system based on blockchain technology is established in this paper to better control quality problems of the key nodes of the wind turbine blade supply chain. Firstly, the framework of this system is illustrated to build the relationship between six key nodes. Then, we explain the wallet structure and information on the chain method. Finally, the operation results of this system are given to demonstrate its validity.

For the application in wind turbine blade supply chain, this system can reduce packing charges and protect the privacy of users, because when uploading the information of each node in the supply chain, the actual data uploaded by the system is the hash fingerprint information. By comparing the fingerprint information, the original information also cannot be tampered. This system also publishes the SDK defined in the open source organization, which completes the information on-chain method by creating three main processes of signature and submission. The traceability of information in smart phones is shown and a successful result is obtained. This system can provide quality traceability for the wind turbine blade supply chain, ensure the safety and transparency of user information and better monitor the quality problems in the supply chain. Additionally, the proposed blockchain-based system can not only be used in the green composite wind turbine blade supply chain, but also be extended to other similar supply chains. To improve the applicability, it is worth testing the proposed blockchain-based systems in future research from various aspects, such as the block size, the number of peers, throughput, latency, consensus algorithm and wallet structure.

In the future, 5G will start to build base stations all around the world, and blockchain technology will play a more important role in supply chain. Combined with the Internet of Things technology, it can not only trace the source of quality problems, but also monitor the whole supply chain in real time. The accelerated integration of these three technologies will probably completely change the operation mode of wind energy technology and other industry supply chains. These three technologies will make up for each other's shortcomings and accelerate the intelligent application of the supply chain.

**Author Contributions:** Conceptualization, H.Y., S.Z. and J.Y.; methodology, H.Y. and S.Z.; software, H.Y. and J.Y.; validation, S.Z. and J.Y.; formal analysis, S.Z.; investigation, H.Y.; resources, H.Y.; data curation, S.Z.; writing—original draft preparation, H.Y. and S.Z.; writing—review and editing, J.Y.; supervision, S.Z.; funding acquisition, S.Z. and J.Y. All authors have read and agreed to the published version of the manuscript.

**Funding:** This research was funded by the Humanities and Social Science Foundation of the Ministry of education in China, grant number 18YJCZH274; the Science and Technology Project of Jiangsu Province, China, grant number BK20190926; and the Research Fund of Xinlin College of Nantong University, grant number 2018K109.

**Institutional Review Board Statement:** The study was conducted according to the guidelines of the Declaration of Helsinki, and approved by the Institutional Review Board (or Ethics Committee) of Nantong University.

**Informed Consent Statement:** Informed consent was obtained from all subjects involved in the study.

**Data Availability Statement:** The data presented in this study are available on request from the corresponding author.

**Acknowledgments:** The authors are grateful for comments made by anonymous referees.

**Conflicts of Interest:** The authors declare no conflict of interest.

## References

- Andoni, M.; Robu, V.; Flynn, D.; Abram, S.; Geach, D.; Jenkins, D.; McCallum, P.; Peacock, A. Blockchain Technology in the Energy Sector: A Systematic Review of Challenges and Opportunities. *Renew. Sustain. Energy Rev.* **2019**, *100*, 143–174. [[CrossRef](#)]
- Ashik, K.; Sharma, R.S.; Gupta, V.J. Investigation of Moisture Absorption and Mechanical Properties of Natural/Glass Fiber Reinforced Polymer Hybrid Composites. *Mater. Today Proc.* **2018**, *5*, 3000–3007. [[CrossRef](#)]
- Singh, A.; Ahuja, H.; Bhadoria, V.S.; Singh, S. Control Implementation of Squirrel Cage Induction Generator Based Wind Energy Conversion System. *J. Sci. Ind. Res.* **2020**, *79*, 306–311.
- Ahmed, M.M.; Dhakal, H.N.; Zhang, Z.Y.; Barouni, A.; Zahari, R. Enhancement of Impact Toughness and Damage Behaviour of Natural Fibre Reinforced Composites and Their Hybrids through Novel Improvement Techniques: A Critical Review. *Compos. Struct.* **2021**, *259*, 113496.
- Alsubari, S.; Zuhri, M.; Sapuan, S.; Ishak, M.; Ilyas, R.; Asyraf, M. Potential of Natural Fiber Reinforced Polymer Composites in Sandwich Structures: A Review on Its Mechanical Properties. *Polymers* **2021**, *13*, 423. [[CrossRef](#)] [[PubMed](#)]
- Panciroli, R.; Giannini, O. Comparing the Impact Resistance of Flax/Epoxy and Glass/Epoxy Composites through Experiments and Numerical Simulations. *Compos. Struct.* **2021**, *264*, 113750. [[CrossRef](#)]
- Saini, M.K.; Bagha, A.K.; Kumar, S.; Bahl, S. Finite Element Analysis for Predicting the Vibration Characteristics of Natural Fiber Reinforced Epoxy Composites. *Mater. Today Proc.* **2021**, *41*, 223–227. [[CrossRef](#)]
- Mondragon, A.; Mondragon, C.; Coronado, E.S. Exploring the Applicability of Blockchain Technology to Enhance Manufacturing Supply Chains in the Composite Materials Industry. In Proceedings of the 2018 IEEE International Conference on Applied System Innovation (ICASI), Chiba, Japan, 13–17 April 2018.
- Das, P.P.; Acharya, A.; Chaudhary, V. Influence of Moisture Uptake on the Mechanical Properties of Natural Fiber-Reinforced Polymer Composites. In *Composite Materials*; Sachdeva, A., Singh, P.K., Rhee, H.W., Eds.; CRC Press: Boca Raton, FL, USA, 2021; pp. 213–222.
- Srinivasan, T.; Suresh, G.; Ramu, P.; Ram, V.G.; Giresh, M.; Arjun, K. Effect of Water Absorption of the Mechanical Behavior of Banana Fiber Reinforced IPN Natural Composites. *Mater. Today Proc.* **2021**, *45*, 1334–1337. [[CrossRef](#)]
- Li, X.L.; Sun, J.; Tao, N.; Feng, L.; Shen, J.L.; He, Y.; Zhang, C.; Zhao, Y.J. An Effective Method to Inspect Adhesive Quality of Wind Turbine Blades Using Transmission Thermography. *J. Nondestruct. Eval.* **2018**, *37*, 1–11. [[CrossRef](#)]
- Posa, A. Dependence of the Wake Recovery Downstream of a Vertical Axis Wind Turbine on Its Dynamic Solidity. *J. Wind Eng. Ind. Aerodyn.* **2020**, *202*, 104212. [[CrossRef](#)]
- Kumar, P.; Rajan, A.J. Knowledge Management Based Supplier Selection of Wind Turbine Manufacturer Supply Chain. *Int. J. Knowl. Manag. Stud.* **2019**, *10*, 3–20. [[CrossRef](#)]
- Yuan, J.; Sun, S.; Shen, J.; Xu, Y.; Zhao, C. Wind Power Supply Chain in China. *Renew. Sustain. Energy Rev.* **2014**, *39*, 356–369. [[CrossRef](#)]
- Feng, H.; Wang, X.; Duan, Y.; Zhang, J.; Zhang, X. Applying Blockchain Technology to Improve Agri-Food Traceability: A Review of Development Methods, Benefits and Challenges. *J. Clean. Prod.* **2020**, *260*, 121031. [[CrossRef](#)]
- Oham, C.; Michelin, R.A.; Jurdak, R.; Kanhere, S.S.; Jha, S. B-FERL: Blockchain Based Framework for Securing Smart Vehicles. *Inf. Process. Manag.* **2021**, *58*, 102426. [[CrossRef](#)]

17. Upadhyay, A.; Mukhuty, S.; Kumar, V.; Kazancoglu, Y. Blockchain Technology and the Circular Economy: Implications for Sustainability and Social Responsibility. *J. Clean. Prod.* **2021**, *293*, 126130. [[CrossRef](#)]
18. Hakak, S.; Khan, W.Z.; Gilkar, G.A.; Imran, M.; Guizani, N. Securing Smart Cities through Blockchain Technology: Architecture, Requirements, and Challenges. *IEEE Netw.* **2020**, *34*, 8–14. [[CrossRef](#)]
19. Kouhizadeh, M.; Saberi, S.; Sarkis, J. Blockchain Technology and the Sustainable Supply Chain: Theoretically Exploring Adoption Barriers. *Int. J. Prod. Econ.* **2021**, *231*, 107831. [[CrossRef](#)]
20. Berdik, D.; Otoum, S.; Schmidt, N.; Porter, D.; Jararweh, Y. A Survey on Blockchain for Information Systems Management and Security. *Inf. Process. Manag.* **2021**, *58*, 102397. [[CrossRef](#)]
21. Li, X.; Wang, D.; Li, M. Convenience Analysis of Sustainable E-Agriculture Based on Blockchain Technology. *J. Clean. Prod.* **2020**, *271*, 122503. [[CrossRef](#)]
22. Pradana, I.G.M.T.; Djatna, T.; Hermadi, I. Blockchain Modeling for Traceability Information System in Supply Chain of Coffee Agroindustry. In Proceedings of the 2020 International Conference on Advanced Computer Science and Information Systems (ICACISIS), Jawa Barat, Indonesia, 17–18 October 2020; pp. 217–224.
23. Bodkhe, U.; Tanwar, S.; Parekh, K.; Khanpara, P.; Tyagi, S.; Kumar, N.; Alazab, M. Blockchain for Industry 4.0: A Comprehensive Review. *IEEE Access* **2020**, *8*, 79764–79800. [[CrossRef](#)]
24. Ada, N.; Kazancoglu, Y.; Sezer, M.D.; Ede-Senturk, C.; Ozer, I.; Ram, M. Analyzing Barriers of Circular Food Supply Chains and Proposing Industry 4.0 Solutions. *Sustainability* **2021**, *13*, 6812. [[CrossRef](#)]
25. Varriale, V.; Cammarano, A.; Michelino, F.; Caputo, M. Sustainable Supply Chains with Blockchain, IoT and RFID: A Simulation on Order Management. *Sustainability* **2021**, *13*, 6372. [[CrossRef](#)]
26. Chen, N.-P.; Shen, K.-Y.; Liang, C.-J. Hybrid Decision Model for Evaluating Blockchain Business Strategy: A Bank's Perspective. *Sustainability* **2021**, *13*, 5809. [[CrossRef](#)]
27. Zeadally, S.; Abdo, J.B. Blockchain: Trends and Future Opportunities. *Internet Technol. Lett.* **2019**, *2*, e130. [[CrossRef](#)]
28. Wan, S.; Li, M.; Liu, G.; Wang, C. Recent Advances in Consensus Protocols for Blockchain: A Survey. *Wirel. Netw.* **2020**, *26*, 5579–5593. [[CrossRef](#)]
29. Bano, S.; Sonnino, A.; Al-Bassam, M.; Azouvi, S.; Danezis, G. Consensus in the Age of Blockchains. *arXiv* **2017**, arXiv:1711.03936.
30. Song, J.G.; Moon, S.J.; Jang, J.W. A Scalable Implementation of Anonymous Voting over Ethereum Blockchain. *Sensors* **2021**, *21*, 3958. [[CrossRef](#)] [[PubMed](#)]
31. Pham, H.L.; Tran, T.; Nakashima, Y. A Secure Remote Healthcare System for Hospital Using Blockchain Smart Contract. In Proceedings of the 2018 IEEE Globecom Workshops (GC Wkshps), Abu Dhabi, United Arab Emirates, 9–13 December 2018.
32. Buterin, V. A Next-Generation Smart Contract and Decentralized Application Platform. *White Pap.* **2014**, *3*, 37.
33. Androulaki, E.; Manevich, Y.; Muralidharan, S.; Murthy, C.; Laventman, G. Hyperledger Fabric: A Distributed Operating System for Permissioned Blockchains. In Proceedings of the Thirteenth EuroSys Conference, Porto, Portugal, 23–26 April 2018.
34. Sukhwani, H.; Martínez, J.M.; Chang, X.; Trivedi, K.S.; Rindos, A. Performance Modeling of PBFT Consensus Process for Permissioned Blockchain Network (Hyperledger Fabric). In Proceedings of the 2017 IEEE 36th Symposium on Reliable Distributed Systems (SRDS), Hong Kong, China, 26–29 September 2017.
35. Zheng, Z.; Xie, S.; Dai, H.; Chen, X.; Wang, H. An Overview of Blockchain Technology: Architecture, Consensus, and Future Trends. In Proceedings of the 6th IEEE International Congress on Big Data, Seattle, WA, USA, 10–13 December 2017.
36. Dinh, T.; Wang, J.; Chen, G.; Liu, R.; Ooi, B.C.; Tan, K.L. BLOCKBENCH: A Framework for Analyzing Private Blockchains. In Proceedings of the 2017 ACM International Conference on Management of Data, New York, NY, USA, 14–19 May 2017.
37. Jamil, F.; Iqbal, N.; Imran, Ahmad, S.; Kim, D.H. Peer-to-Peer Energy Trading Mechanism Based on Blockchain and Machine Learning for Sustainable Electrical Power Supply in Smart Grid. *IEEE Access* **2021**, *9*, 39193–39217. [[CrossRef](#)]
38. Iqbal, N.; Jamil, F.; Ahmad, S.; Kim, D.H. A Novel Blockchain-based Integrity and Reliable Veterinary Clinic Information Management System using Predictive Analytics for Provisioning of Quality Health Services. *IEEE Access* **2021**, *9*, 8069–8098. [[CrossRef](#)]
39. Shahbazi, Z.; Byun, Y.C. A Procedure for Tracing Supply Chains for Perishable Food Based on Blockchain, Machine Learning and Fuzzy Logic. *Electronics* **2020**, *10*, 41. [[CrossRef](#)]
40. Shahbazi, Z.; Byun, Y.C. Integration of Blockchain, IoT and Machine Learning for Multistage Quality Control and Enhancing Security in Smart Manufacturing. *Sensors* **2021**, *21*, 1467. [[CrossRef](#)]
41. Jabbar, S.; Lloyd, H.; Hammoudeh, M.; Adebisi, B.; Raza, U. Blockchain-Enabled Supply Chain: Analysis, Challenges, and Future Directions. *Multimed. Syst.* **2020**, 1–20. [[CrossRef](#)]
42. Cui, P.; Dixon, J.; Guin, U.; Dimase, D. A Blockchain-Based Framework for Supply Chain Provenance. *IEEE Access* **2019**, *7*, 157113–157125. [[CrossRef](#)]
43. Kumiawan, H.; Kim, J.Y.; Ju, H. Utilization of the Blockchain Network in The Public Community Health Center Medicine Supply Chain. In Proceedings of the 2020 21st Asia-Pacific Network Operations and Management Symposium (APNOMS), Daegu, Korea, 23–25 September 2020.
44. Nanayakkara, S.; Perera, S.; Senaratne, S.; Weerasuriya, G.T.; Bandara, H.M.N.D. Blockchain and Smart Contracts: A Solution for Payment Issues in Construction Supply Chains. *Informatics* **2021**, *8*, 36. [[CrossRef](#)]
45. Shahzad, A.; Zhang, K.; Gherbi, A. Intuitive Development to Examine Collaborative IoT Supply Chain System Underlying Privacy and Security Levels and Perspective Powering through Proactive Blockchain. *Sensors* **2020**, *20*, 3760. [[CrossRef](#)]

46. Yoo, M.; Won, Y. A Study on the Transparent Price Tracing System in Supply Chain Management Based on Blockchain. *Sustainability* **2018**, *10*, 4037. [[CrossRef](#)]
47. Liu, L.; Li, F.; Qi, E. Research on Risk Avoidance and Coordination of Supply Chain Subject Based on Blockchain Technology. *Sustainability* **2019**, *11*, 2182. [[CrossRef](#)]
48. Park, K.O. A Study on Sustainable Usage Intention of Blockchain in the Big Data Era: Logistics and Supply Chain Management Companies. *Sustainability* **2020**, *12*, 10670. [[CrossRef](#)]
49. Malik, S.; Kanhere, S.S.; Jurdak, R. ProductChain: Scalable Blockchain Framework to Support Provenance in Supply Chains. In Proceedings of the 2018 IEEE 17th International Symposium on Network Computing and Applications (NCA), Cambridge, MA, USA, 1–3 November 2018.
50. Gao, K.; Liu, Y.; Xu, H.; Han, T. Hyper-FTT: A Food Supply-Chain Trading and Traceability System Based on Hyperledger Fabric. Blockchain and Trustworthy Systems. In *Blockchain and Trustworthy Systems*; Zheng, Z., Dai, H., Tang, M., Chen, X., Eds.; Springer: Berlin/Heidelberg, Germany, 2020; pp. 648–661.
51. Helo, P.; Hao, Y. Blockchains in Operations and Supply Chains: A Model and Reference Implementation—Science Direct. *Comput. Ind. Eng.* **2019**, *136*, 242–251. [[CrossRef](#)]
52. Salah, K.; Nizamuddin, N.; Jayaraman, R.; Omar, M. Blockchain-based Soybean Traceability in Agricultural Supply Chain. *IEEE Access* **2019**, *7*, 73295–73305. [[CrossRef](#)]
53. Tian, F. An Agri-Food Supply Chain Traceability System for China Based on RFID & Blockchain Technology. In Proceedings of the 2016 13th International Conference on Service Systems and Service Management (ICSSSM), Kunming, China, 24–26 June 2016. [[CrossRef](#)]