



Article

Overall Efficiency of On-Site Production and Storage of Solar Thermal Energy

Teodora M. Șoimoșan ^{1,*}, Ligia M. Moga ¹, Livia Anastasiu ¹, Daniela L. Manea ¹, Aurica Căzilă ² and Čedomir Zeljković ³

¹ Faculty of Civil Engineering, Technical University of Cluj-Napoca, 400020 Cluj-Napoca, Romania; Ligia.Moga@ccm.utcluj.ro (L.M.M.); Livia.Anastasiu@ccm.utcluj.ro (L.A.); Daniela.Manea@ccm.utcluj.ro (D.L.M.)

² Faculty of Automotive, Mechatronics and Mechanical Engineering, Technical University of Cluj-Napoca, 400641 Cluj-Napoca, Romania; CazilaAurica@gmail.com

³ Faculty of Electrical Engineering, University of Banja Luka, 78000 Banja Luka, Bosnia and Herzegovina; cedimir.zeljkovic@etf.unibl.org

* Correspondence: Teodora.Soimosan@mtc.utcluj.ro

Abstract: Harnessing renewable energy sources (RES) using hybrid systems for buildings is almost a deontological obligation for engineers and researchers in the energy field, and increasing the percentage of renewables within the energy mix represents an important target. In crowded urban areas, on-site energy production and storage from renewables can be a real challenge from a technical point of view. The main objectives of this paper are quantification of the impact of the consumer's profile on overall energy efficiency for on-site storage and final use of solar thermal energy, as well as developing a multicriteria assessment in order to provide a methodology for selection in prioritizing investments. Buildings with various consumption profiles lead to achieving different values of performance indicators in similar configurations of storage and energy supply. In this regard, an analysis of the consumption profile's impact on overall energy efficiency, achieved in the case of on-site generation and storage of solar thermal energy, was performed. The obtained results validate the following conclusion: On-site integration of solar systems allowed the consumers to use RES at the desired coverage rates, while restricted by on-site available mounting areas for solar fields and thermal storage, under conditions of high energy efficiencies. In order to segregate the results and support optimal selection, a multicriteria analysis was carried out, having as the main criteria the energy efficiency indicators achieved by hybrid heating systems.

Keywords: solar; thermal energy; buildings; heating system; efficiency; performance indicator; environmental; multicriteria analysis



Citation: Șoimoșan, T.M.; Moga, L.M.; Anastasiu, L.; Manea, D.L.; Căzilă, A.; Zeljković, Č. Overall Efficiency of On-Site Production and Storage of Solar Thermal Energy. *Sustainability* **2021**, *13*, 1360.

<https://doi.org/10.3390/su13031360>

Academic Editor: Miguel Ángel Reyes Belmonte

Received: 22 December 2020

Accepted: 24 January 2021

Published: 28 January 2021

Publisher's Note: MDPI stays neutral with regard to jurisdictional claims in published maps and institutional affiliations.



Copyright: © 2021 by the authors. Licensee MDPI, Basel, Switzerland. This article is an open access article distributed under the terms and conditions of the Creative Commons Attribution (CC BY) license (<https://creativecommons.org/licenses/by/4.0/>).

1. Introduction

Harnessing renewable energy sources (RES) using hybrid systems for buildings is almost a deontological obligation for engineers and researchers in the energy field, and increasing the percentage of renewables within the energy mix represents an important target in the energy sector. Nevertheless, in most countries, the share of RES in the energy mix is still insignificant [1]. For example, in 2019, in Romania, solar energy delivered to the final client was less than 2.7%, referring to the production of electricity, with solar thermal energy being almost non-existent [2].

Among the different aspects of assuring sustainability throughout the entire energy chain—generation, storage, transport, distribution, final use, and recovery—energy economy and energy efficiency are the main valences of the process' sustainability. As stated in the 2019 International Energy Agency (IEA) Report, "Energy efficiency is at the heart of any strategy to guarantee secure, sustainable and inclusive economic growth" [3]. Follow-

ing this, the algorithm for the selection of the best scenarios in prioritizing RES investments must rely on energy performance indicators.

The latest European concept promoted in urban localities, the concept of “smart city”, involves meeting several requirements of planning and sustainable development simultaneously. Although the “smart” feature of a city mainly involves efficient human and social management, the concept of “smart city” is extended, in the field of urban infrastructure, by implementing modern and sustainable energy solutions, in other words, “smart energy”.

The concept of “smart city” implies more than the use of information and communication technology in the process of managing energy resources, to consequently reduce greenhouse gas emissions. It also involves finding efficient ways to meet the energy demands of urban buildings and increasing the share of renewable energy sources in the energy mix of urban district—trends that are reflected in the new values of energy indicators [4] and, subsequently, in the structure of the final energy consumption [5,6], such as:

- Adopting strategies focused on increasing RES use for energy production [7];
- Developing stochastic methods and real-time monitoring tools for energy assessment of RES-based energy production systems within urban areas [8];
- Finding alternative systems, based on RES, for the production of thermal and electrical energy for buildings [9,10] or for the reduction of the energy consumption of buildings [11], etc.

Altogether, the concept of “smart energy” has the following valences, as pointed out in Figure 1:

- Energetic security;
- Competitiveness of the energy markets;
- Reducing energy poverty and protection of the vulnerable consumer;
- Environmental protection, including of the air quality.

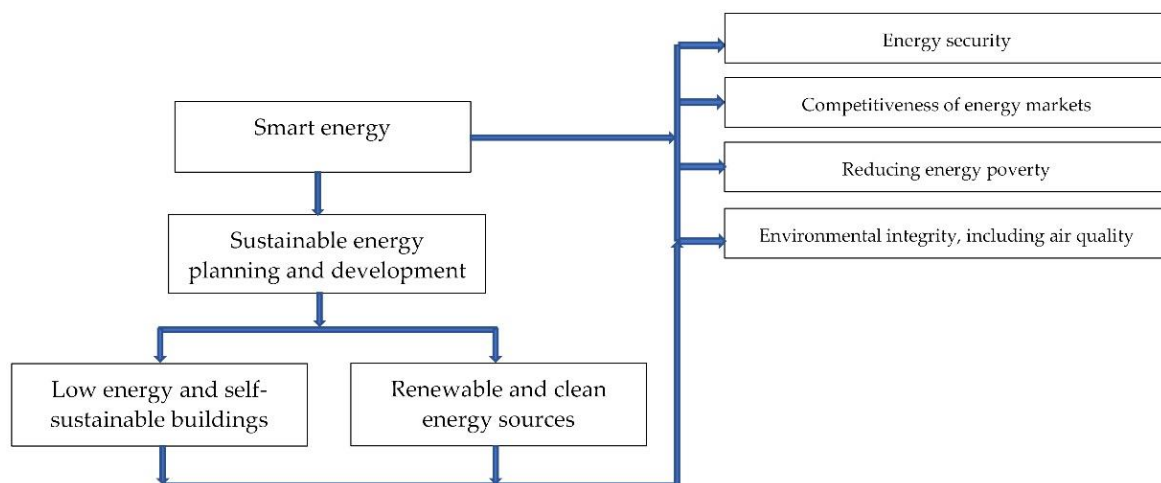

Figure 1. Energetic sustainability.

One of the current axes of European energetics is the development of distributed energy production. This type of infrastructure is not only favorable for supplying remote consumers but also allows switching of the state of on-grid buildings from energy consumers to energy prosumers. On this axis, the use of the highest possible levels of clean and renewable energy in self-sustaining buildings, i.e., buildings with low energy consumption, nearly zero-energy buildings (nZEB), active buildings, etc., is defining.

In terms of energy consumption in Romania, the residential sector covers 37% of the structure of Romanian energy consumption, and the tertiary consumption is 23%, with the

difference being represented by the industrial and transport sectors [12]. The prevailing thermoenergetic systems are the individual ones, based on biomass—mainly ligneous mass or natural gases [13]—with district heating operating via cogeneration using natural gases (54%), oil (26%), and coal (20%) [12]. It is therefore necessary to rethink the thermoenergetic system, with the integration of renewable and clean resources. Inasmuch as the vast majority of the systems are existing energy systems, the on-site integration of clean resources represents an opportunity in this regard. Furthermore, for the building sector, the energy strategy is oriented toward renovation, being thought "neutral" from the technological point of view. Its rethinking generates high investments in the building sector, both for the construction of new buildings and retrofitting the existing ones, which overlaps the requirement of approaching the above objectives, leading to the necessity of creating a sustainable planning and decision-making tool in the investment process.

Multicriteria methods for analyzing and selecting the best techno-economical solution are well-known today. However, they are less represented in the constructions field in many countries [14], especially when used for prioritizing upgrading activities of the existing constructions and installations related to urban areas, such as districtual energy systems and urban energy consumers [15]. On the other hand, at the global level, the criteria commonly used when comparing hybrid systems are based on economic, financial, social, and environmental impact aspects [16–18], with the last one tending to be the important one nowadays, due to intensive actions against climate change. Mardani et al., in an overview of the application of multicriteria decision-making techniques and approaches [19], classified the methods into two main application categories: sustainable energy and renewable energy. Both were developed considering different categories of criteria, then providing tools in order to establish relations between alternatives. Taking into account important business aspects such as profit, financial risk, resources, management capacity, etc., Lin and Yang provide a useful model for the decision-making process of construction projects based on analytic network process (ANP). Furthermore, there where approaches in the last few years, from the energetic point of view, in which aspects such as efficiency of the envelopes and energy systems were taken into account, constituting different criteria. For e.g., Abdelazim et al. developed an analytic hierarchy process (AHP) method in order to establish sustainability ranking for existing systems in Egypt, using criteria such as the use of RES; buildings' envelope efficiency strategies; use of energy-efficient appliances and equipment; building systems automation; refrigerants' type; fire suppression systems; operation and maintenance practices; metering or sub-metering of building, zones and systems; and the impact of transportation [20]. These criteria permit ranking of the buildings in order to establish, in general, the sustainability level of a building or to frame a building in different classes of performance. In this kind of approach, the restriction consists in a threshold value of a criterion; in the case above, the minimum energy performance set to be achieved.

In most cases, the considered criteria tend to be conflicting [21–23], such situations occurring mainly when the criteria tend to be of a different nature, for example economic and environmental, profit and social, characteristics and costs [21,24–27], etc. Moreover, the criteria weights, especially when they are of different types (economic, social, financial, environmental), have a predominantly subjective feature [28]. In these situations, the results are not always certain, the possible scenarios tending to be ranked according to subjective parameters [15]. Regarding the heating sector, less attention has been paid to technical-efficiency aspects. For a newly designed system, technical efficiency is ensured through a proper sizing and selection of system components and its operation regime [27]. For an existing heating system found during retrofitting and converted into a hybrid heating system process, in addition to the technical efficiencies of the existing components, both the overall efficiency of the hybrid system and the efficiency of renewable resources' integration should be considered. Unlike the above-mentioned studies, in order to evaluate the overall efficiency in the retrofitting process, the authors argue that it is of interest to rank the alternatives according to the criteria from the same category. Thus, the results are segregated according to a global matrix, while keeping the other involved parameters, e.g.,

costs and used land footprint, as quantifiable restrictions in selecting the available collector field surfaces, especially since in urban areas, the available land is usually strictly limited in terms of surface and utilization.

In order to contribute to the complex frame of multicriteria analysis, the paper aims to provide an operational-efficiency approach, because a system with high efficiency in operation also achieves the optimal environmental impact indicators [29]. Based on this different approach, ranking overall efficiencies of the hybrid systems leads to the investments' ranking. As inputs in the process, the financial aspect and the land footprint have been set as restrictions. In this regard, a specific collector fields' area was imposed, serving as a reference too, and the main objective is achieving the highest performances in operation. The purpose of the paper is to contribute to the methodological frame with a methodology based on the AHP method for prioritizing on-site RES investments, in urban areas characterized by high construction and thermal energy density, within existing heating systems. The overall efficiency of the on-site production and storage of the solar thermal energy is modeled and quantified in the process.

2. Materials and Methods

2.1. Criteria Description, Energy Performance Indicators

In order to perform a multicriteria analysis of the impact of a buildings' characteristics on the use of solar energy, the authors defined the following global indicators of annual energy performance, related to the hybrid heating system, indicators that are constituted in the criteria, as follows.

C1. Indicator of conventional annual primary energy, $E_{p_{conv}}^a$

$$E_{p_{conv}}^a = \frac{E_{p_{conv}}}{A_h} = \frac{\sum_j (E_{del,j} - E_{exp,j}) \cdot f_j}{A_h} \quad (1)$$

where

$E_{p_{conv}}$ is the annual consumption of primary energy of the conventional heating sources, used for heating, ventilation, and domestic hot water preparation (dhw) in building, in kWh/year;

A_h is the heated area of the building, in m²;

$E_{del,j}$ is the final energy, annually delivered to the building, related to the conventional fuel of type "j", in kWh/year;

$E_{exp,j}$ is the energy, annually generated at the level of the building and redirected into the district heating system, related to the conventional fuel of type "j", in kWh/year;

f_j is the conversion factor into the primary energy, of the final energy of type "j" [-].

A working hypothesis in determining the conventional annual primary indicator was considered as follows: the situation of thermal consumers connected to the district heating system, operating on conventional fuel, without conventional energy components exported by consumers into the network; this situation has been targeted, as it is desirable in respect to the environmental integrity.

C2. RES harnessing indicator in the building, I_{RES}^a

I_{RES}^a represents the annual share of energy participation obtained from RES, in the total energy consumption of the building, in relation to the total primary energies.

$$I_{RES}^a = \frac{E_{p_{RES}}}{E_{p_{RES}} + E_{p_{conv}}} = \frac{\sum_i (E_{del,i} - E_{exp,i}) \cdot f_i}{\sum_i (E_{del,i} - E_{exp,i}) \cdot f_i + \sum_j E_{conv,j} \cdot f_j} \quad (2)$$

where

$E_{p_{RES}}$ is the annual primary energy obtained from renewables (RES) and used in the building, in kWh/year;

$E_{p_{conv}}$ is the annual primary energy obtained from conventional energy sources and used in the building, in kWh/year;

$E_{del,i}$ is the annual final energy delivered to the building, related to RES of type "i", in kWh/year;

$E_{exp,i}$ is the annual on-site generated energy in building or nearby and redirected into the district heating energy system, related to RES of type "i", in kWh/year;

$E_{conv,j}$ is the annual energy delivered to the building from conventional energy sources of type "j", in kWh/year;

$f_{i,j}$ represents factors of conversion into primary energy, of the final energy of type "i", "j", respectively.

As a working hypothesis, we considered the situation of a thermal consumer, a building connected to the district heating system, with the renewable energy component exported by the consumer in the network on the "feed-in" principle. Particularly, the exported renewable energy component consists of excess energy that occurs during periods without or with low energy consumption at the consumer but with availability of the solar resource. This hypothesis is pursued because it leads to the highest values of energy performances in operation.

The indicator of annual performance, I_{RES}^a , reflects the degree of the balance established between the level of energy efficiency of the building, achieved as a result of efficiency measures undertaken at the level of the building's envelope and heating system, and the harnessing degree of the energy generated on-site from renewable energy sources, in the building or in the immediate vicinity. The values of I_{RES}^a reflect the degree of effective harnessing of the energy obtained from renewables, in buildings, without the energetic component, $Q_{feed-in}$, delivered into the district heating system.

C3. RES participation in thermoenergetic systems, α_{RES}^a and annual solar fraction, F_S^a

One of the main indicators of energy performance of the hybrid heating system is the level of participation of renewable energy resources in covering the consumers' demand for thermal energy. The annual participation quota of the solar thermal resource is expressed by Relation (3).

$$\alpha_{RES}^a = 100 \cdot \frac{Q_{RES}^a}{Q_h^a}, \quad (3)$$

where Q_{RES}^a is the annual thermal energy related to RES, in kWh/year, and Q_h^a is the annual thermal energy demand for space heating, ventilation, and dhw, in MWh/year. In the case of thermo-solar systems, the participation quota can be represented by the solar fraction, F_S^a (4).

$$F_S^a = 100 \cdot \frac{Q_s^a}{Q_{conv}^a + Q_s^a}, \quad (4)$$

where Q_s^a is the annual solar thermal energy to the system, in kWh/year, and Q_{conv}^a is the annual conventional energy to the system, in kWh/year.

C4. Solar collector field efficiency, E_{fc}^a

The annual energy efficiency of the solar collector field is defined as a ratio between the annual amount of useful thermal energy supplied to the system and the area of the solar collector field, according to Relation (5) below.

$$E_{fc}^a = \frac{Q_s^a}{A_c}, \quad (5)$$

where

Q_s^a is the annual amount of solar thermal energy delivered into the system, in kWh/year;
 A_c is the area of the solar collector field, in m².

C5. Solar collector yield, η_c

Represents the ratio between the solar thermal energy delivered into the system and the total irradiation onto the collector area.

C6. Annual global energy efficiency of the hybrid heating system, E_f^a

$$E_f^a = \frac{Q_h^a}{E_{pconv} + E_p} \quad (6)$$

where

Q_h^a is the annual amount of heat consumption for space heating, ventilation, and domestic hot water preparation of the building, in MWh/year;

E_{pconv} is the annual consumption of primary energy, i.e., electricity and fuels energy, of the conventional heating sources, in kWh/year;

E_p is the annual consumption of electricity by the pumping, automation, and control system, in kWh/year.

C7. Specific indicator of equivalent emissions, e_{mCO_2} , in $\text{kgCO}_2 \text{equiv.}/(\text{m}^2 \text{ year})$

In the case of hybrid energy systems, in order to analyze their performance in comparison with the conventional system for reference, the total avoided amount of $\text{CO}_2 \text{equiv.}$ emissions is additionally used as an annual environmental performance indicator. In this case, in order to perform the comparative impact analysis between buildings with different constructive and functional characteristics and different energy consumptions, the specific indicator e_{mCO_2} was used, determined by reporting the total carbon emissions to the heated area of the building (7).

$$e_{mCO_2} = \frac{E_{pconv,j} \cdot f_{CO_2,j}}{A_h} \quad (7)$$

where

$E_{pconv,j}$ represents the annual consumptions of primary conventional energy type "j", electricity, and fuels energy, in kWh/year;

$f_{CO_2,j}$ is the $\text{CO}_2 \text{equiv.}$ emission factor, related to the energy type "j", in $\text{kgCO}_2 \text{equiv.}/\text{kWh}$.

A_h is the heated area of the building, in m^2 .

The restrictions (R1, R2) imposed within the optimization algorithm in the configuration stage of the hybrid systems in buildings are as following:

- R1. Covering the building's heat demand throughout the calendar year;
- R2. Land use footprint.

The land use footprint represents the share of land used for the exploitation and storage of renewable energy, without the possibility of allocating the used area for other activities such as agriculture, construction, etc., in m^2/kWh . This indicator, negligible in the case of conventional heating systems, acquires importance in the case of systems based on renewables such as wind, solar, and geothermal energy, due to their impact on the land use, generated by the capture, conversion, and storage of energy.

2.2. Multicriteria Analysis

The criteria usually used when comparing hybrid systems are based on economic, financial, social, and environmental impact aspects, the last one tending to be the most important one nowadays, due to the intensive action against climate change. The authors proposed to use criteria from a single category. In this sense, the present approach is from an operational-efficiency point of view, since a system with high efficiency in operation also achieves optimal environmental impact indicators [29].

In order to carry out the multicriteria analysis, to select the best alternative in terms of operating efficiency, the alternatives consist of different types of thermal consumers (buildings), B_i , constitutes the matrix of study alternatives $B = [B_i]$, where $i = 1-7$ represents the number of the alternative, according to the case study configured in Section 3.1.

The previously defined criteria constitute the criterion matrix $C = [C_j]$, where $j = 1-7$ represents the number of the criterion. The following goals are pursued:

- To minimize criteria C1, C7;
- To maximize criteria C2–C6, as previously defined.

The next step is configuring of the overall efficiency matrix $E = [E_{ij}]$.

From the multicriteria analyses and decision methods, the AHP method was chosen, since it integrates both the quantitative analysis, in the quantification of the tie-breaking criteria, and the qualitative analysis, in establishing the weights of the criteria taken into account [27,30,31]. Because the importance of the criteria can differ significantly, for the quantification of the importance of each criterion (weight), the authors used the qualitative analysis: the criteria's order, priority, and importance, respectively, i.e., the weight coefficients, $k_{w,i,j}$.

3. Case Study Framework

3.1. Buildings as Thermal Consumers

The reference buildings are located in Eastern Europe, in the northwest of Romania. The high number of thermal consumers connected to the centralized system validates the selected city as the optimal location for the case study. Individual and collective residential buildings represent almost 97% of the built fund in the reference city, and 86% of the built fund in Romania. Of these, 52.5% are located in urban areas, and 72% consist of large condominiums or blocks of flats [12,13], for which the sample of the analyzed thermal consumers (Table 1) can be considered representative. Moreover, the local trend in terms of thermoenergy infrastructure is to maintain and retrofit the district heating system, with the integration of renewable energy resources (e.g., geothermal resource).

Table 1. Functional characteristics of buildings B1–B6.

Building	Type	Employment Regime; Operating Regime/Heat Supply Regime
B1	Administrative—Offices	Discontinuous employment regime; 12/12 h—normal operating regime/guard heating and reheating regime
B2	Commercial	Discontinuous employment regime; 12/12 h—normal operating regime/guard heating and reheating regime
B3	Residential—Condominium	Continuous employment regime; normal operating regime
B4	Residential—Condominium	Continuous employment regime; normal operating regime
B5	Residential—Condominium	Continuous employment regime; normal operating regime
B6	Residential—Condominium	Continuous employment regime; normal operating regime
B7	Industrial—Production, Storage and Logistic	Continuous employment regime; normal operating regime
	Industrial—Administrative	Discontinuous employment regime; 12/12 h—normal operating regime without taking into account technological energy consumption/guard heating and reheating regime

The buildings proposed for the thermal energy analysis are located in a geographical area with a moderate-to-cold continental climate, in an urban area, having the following climatic characteristics, according to Romanian norms in force [32,33]:

- Outdoor conventional temperature for heating is $-15\text{ }^{\circ}\text{C}$, the average temperature of ground is $+10\text{ }^{\circ}\text{C}$, and the wind calculation velocity is considered 4 m/s ;
- The average number of days-degrees of calculation is 3150 degree days at $t_{\text{ex}} = +12\text{ }^{\circ}\text{C}$ and 2990 degree days at $t_{\text{ex}} = +10\text{ }^{\circ}\text{C}$. The starting and duration of the heating period is not the same for all buildings. In the case of the district heating system, threshold values for outdoor temperatures that marks the starting and the ending of

the heating period are $t_{ex} = +10$ – 12 °C, accordingly to the buildings specifications, recorded three days in a row;

- The average duration of the conventional heating periods are 195 days at $t_{ex} = +12$ °C and 175 days at $t_{ex} = +10$ °C;
- The annual average of solar radiation is 1150–1250 kWh/m², and the annual duration of sunlight is 2000–2100 h/year, depending on location.

The analyzed buildings B1–B6, having the functional and constructive characteristics indicated in Tables 1 and 2, can be seen in Figure 2. Buildings are connected to the district heating system (DHS).

Table 2. Constructive characteristics of buildings B1–B7.

Building	Height Regime	Built Footprint	Built Volume	Envelope Area	Compactness Ratio	Heated Volume	Heated Area
-	-	m ²	m ³	m ²	m ⁻¹	m ³	m ²
B1	GF + 6L	3574.7	18,067.9	4869.3	0.27	13,545.6	5209.9
B2	SB + GF + 4L	431.0	18,539.0	6473.6	0.35	1623.7	624.5
B3	GF + 9L	2735.8	10,546.4	2851.3	0.27	11,570.6	4450.2
B4	GF + 9L	1749.9	23,300.0	6350.6	0.27	8122.1	3123.9
B5	GF + 8L	3515.9	14,346.8	3976.1	0.28	20,807.6	6778.2
B6	GF + 8L + GF	2265.0	18,125.2	4499.5	0.25	12,983.4	4280.4
B7	GF + 1L	2969.2	61,091.7	15,249.8	0.25	16,525.7	5268.7

GF, ground floor. L, level. SB, semi-basement.

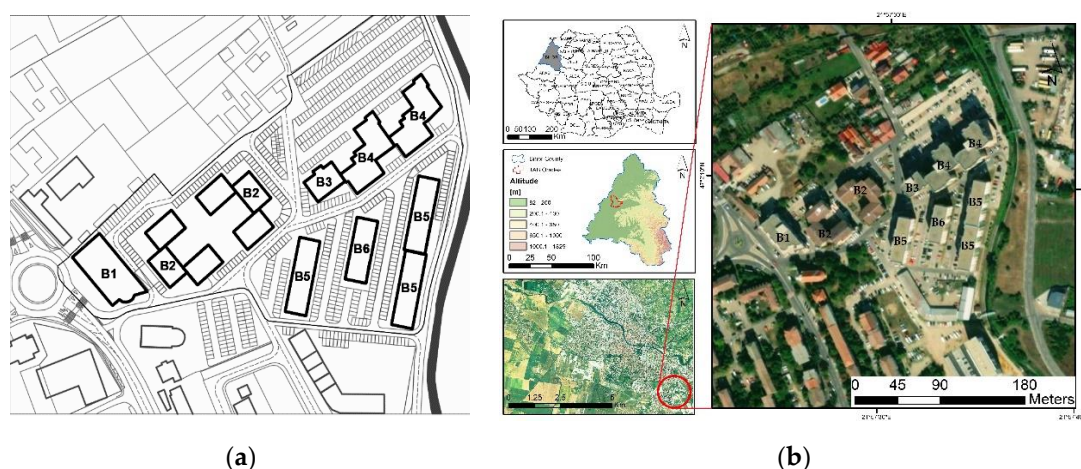

Figure 2. District area. Buildings B1–B6 [34]; (a) site plan. Scale %; (b) site image [35].

The buildings with height regimes, SB + GF + 4–9L, are usually represented by the existing residential buildings, condominium block of flats type, the height regime being characteristic of the location area. Buildings B1–B6 are representative for these types of urban thermal consumers. The constructive characteristics of the reference consumers are in accordance with Table 2.

Rehabilitation and modernization of the building envelopes [36,37] led to the achievement of thermal energy performances depicted in Table 3. The thermoenergetic performances of the buildings were evaluated through the thermotechnical and energetic analysis of the buildings, and of their related thermal systems, according to the norms methodology indicatives C 107 [33], regarding thermotechnical analysis of buildings and Mc 001/2 [38], regarding thermoenergetic analysis of related heating systems. The results obtained are summarized in Table 3. For the determination of the annual heat demand, the thermal energy demands for space heating, ventilation, and domestic hot water preparation (dhw)

were taken into account. The daily considered consumptions of dhw delivered at 50 °C temperature are as follows:

- Residential (condominium): 90 L/person per day;
- Commercial/ Administrative (Offices): 4 L/person per work shift;
- Industrial: 25–57 L/person per work shift.

Table 3. Thermoenergetic characteristics of buildings B1–B7. Matrix of alternatives.

Building	Global Coefficient of Thermal Insulation of Building	Total Annual Consumption of Energy _t ¹ (Space Heating, Ventilation, dhw)	Total Annual Specific Consumption of Energy _t ¹ (Space Heating, Ventilation, dhw)
-	G	Q_h^a	q_h^a
-	W/(m ³ K)	MWh/year	kWh/(m ² year)
B1	0.252	356.3	68.4
B2	0.236	645.4	127.2
B3	0.449	336.5	107.7
B4	0.467	713.3	105.2
B5	0.361	600.5	140.3
B6	0.357	428.8	81.4
B7	0.373	1576.3	241.3
	0.075		
	0.185		

¹ Energy_t represents thermal energy. dhw, domestic hot water.

The urban area, where the targeted buildings are located, is an area with high thermal energy density. The resulting value of the thermal energy density, obtained as a ratio between the thermal energy demand of the buildings and the area of territorial reference unit is 125.37 W/m².

In particular, in the case of industrial buildings connected to the district heating network (e.g., B7), there is the possibility of recovering the technological residual heat. In industry, technological flows usually involve amounts of residual heat with significant thermal potential. In most cases, the heat-carrying agents are air, water, and industrial fluids related to the production processes. By recovering these amounts of heat and redirecting them to the thermal systems that provide indoor microclimate, the thermal energy demand of such an industrial building is significantly reduced. In the present case, in order to compare types of buildings with different characteristics and consumption profiles, the recoverable component of thermal energy was not taken into account, considering instead the thermal energy demands of the building related to space heating, general ventilation, and dhw preparation, for two identified thermal areas of building: the production, storage, and logistics area and the administrative area.

3.2. On-Site Solar Resource

The on-site solar resource (Figure 3) was modeled taking into account the hourly values and daily averages, using in this regard values related to the databases of the Atmospheric Science Data Center [39]. The monthly average values of solar irradiation and wind velocity for the study location are listed in Figure 3. Based on monthly average values, the annual average of the global solar irradiation taken into consideration for the study location is 1249.5 kWh/(m² year).

The evaluation of the existing free surfaces, available for the location of the solar thermal fields in the study area led to the conclusion that the proposed surface, within the frame of the case study, can be placed on roofs of the buildings and parking lots located in immediate vicinity of buildings. The eventual deviation of the solar fields from the south direction is at maximum ±80°. According to the Perez model, even for these deviations, the solar thermal collector fields still capture at least 80% of the maximum solar potential. The representative types of thermal consumers from an urban area and their energy

profiles were modeled, and the energy efficiency analyses for the representative levels of covering energy demands from on-site solar resource were performed, following numerical simulations computed on the platform PolySun [40] for one year of operation of the hybrid systems. The matrix of alternatives is according to Table 4.

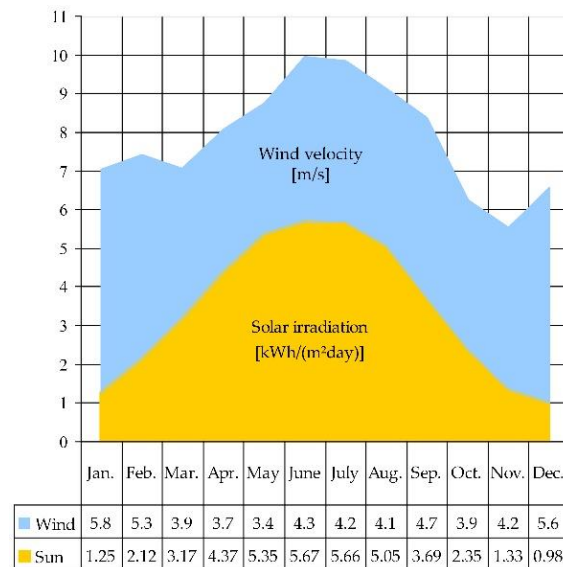

Figure 3. On-site solar resource related to the horizontal surface. Monthly average values.

Table 4. Matrix of alternatives.

Building	Annual Solar Fraction	Collector Field Area		Indicator of Equivalent Area	Irradiation onto Collector Area
-	F_S^a %	A_c	A_a	$I_{s,equiv.}$	I_c MWh/year
B1	43.6			0.72	
B2	36.9			0.61	
B3 ¹	60.3			1.00	
B4	34.6	400	360	0.57	529.12
B5	39.7			0.66	
B6	53.8			0.89	
B7	17.1			0.28	

¹ The solar thermal fields were configured in order to achieve a maximum annual solar fraction of 60% in buildings. In this sense, the smallest consumer, respectively building B3 was set as the reference.

Irradiation onto collector area, I_c , is determined based on the following expression [41].

$$I_c = I_b \cdot R_b + I_d \cdot \left(\frac{1 + \cos \beta}{2} \right) + I_r \cdot \rho \cdot \left(\frac{1 - \cos \beta}{2} \right) \quad (8)$$

where

I_b is direct solar irradiation on the collector area, in kWh/year;

R_b is the ratio of beam radiation on a tilted surface to that on a horizontal surface (the geometric factor);

I_d is the diffuse irradiation normal on the tilted surface of the collector, in kWh/year;

β is the tilt angle of the collector [°];

I_r is the reflected irradiation normal on the tilted surface of the collector, in kWh/year;

ρ is the albedo coefficient.

3.3. Hybrid Heating Systems' Configuration

The case study targets the representative buildings B1–B7, having the thermal energy characteristics specified in Table 3. The temperature values of the thermal agent in the heating network were set at 70/40 °C. The optimized configurations of the thermal solar systems and the attached algorithm of operation and control related to the hybrid heating systems are according to Figure 4 [40].

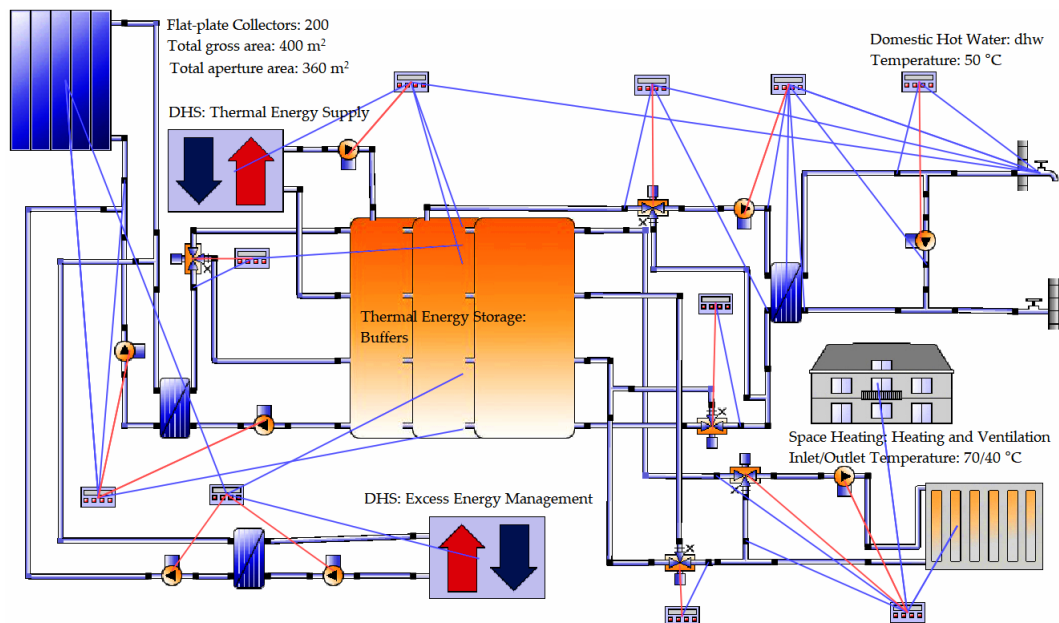

Figure 4. Hybrid heating systems B1–B7. Hydraulic schematic and control algorithm.

In order to compare the impact of the consumption profiles of the buildings on the achieved energy performances, for all targeted buildings, a total gross area of 400 m², comprising 360 m² of aperture area, was taken into account, corresponding to a number of 200 proposed flat-plate-type solar thermal collectors. The selected flat-plate-type collector has the following optical yields: η_o (laminar) = 0.75, respectively η_o (turbulent) = 0.80. The solar thermal field achieves an annual fraction of 60% for the reference building B3. The surface was configured within the limits of available on-site areas, according to (Table 4), taking into account the built density and the energy density of the analyzed land area [29]. The thermal energy storage has a volume of 24 m³ for all targeted buildings, in order to quantify the impact of the consumers profile on energy efficiency of the hybrid system. The designed capacity of storage provides an optimal value of global energy efficiency for the hybrid heating system, in the case of the reference building (B3). The technical rooms for mounting the buffers are available on site.

Decentralized integration of the solar thermal systems allowed the existing thermal consumers to use the solar resource (RES-S) at the desired coverage rates, within the restrictions of the existing available mounting areas for solar fields, under conditions of high energy efficiencies. Decentralized integration of RES-S systems allowed reducing the heating period with respect to the conventional heating sources with up to three months of operation, covering domestic hot water consumption in the spring–summer time, up to 100%, depending on the achievable solar fractions and storage volumes.

The conversion factors of the total final energy into primary energy with respect to the CO₂_{equiv} emission factors were considered compliant as seen in Table 5.

Table 5. Primary energy conversion factors and CO₂_{equiv.} standard emission factors [42].

Energy Source	Primary Energy Conversion Factor			CO ₂ _{equiv.} Standard Emission Factor
	Non-Renewable	Renewable	Total	
Electrical energy from grid	2.62	0.00	2.62	0.299
Cogeneration (DHS)	0.92	0.00	0.92	0.220
Solar thermal energy	0.00	1.00	1.00	0.000

DHS, district heating system.

Following results from numerical simulations performed during one year of operation on the reference buildings, the annual performance indicators set in Section 2.1 were secured and centralized as shown in Table 6.

Table 6. Global indicators of annual energy performance. Matrix of efficiencies.

Bi	Indicator of Conventional Primary Energy in Building	Indicator of RES-S Harness in Building	Annual Solar Fraction	Annual Solar Collector Field Efficiency ¹	Annual Collectors Yield	Global Energy Efficiency of the Hybrid Heating System	Specific Indicator of Equivalent Emissions
-	E_{conv}^a kWh/(m ² year)	I_{RES}^a -	F_S^a %	E_{fc}^a kWh/(m ² year)	η_c %	E_f^a -	e_{mCO_2} kgCO ₂ /(m ² year)
-	C1	C2	C3	C4	C5	C6	C7
B1	38.31	0.46	43.6	419.5	31.7	1.75	8.68
B2	76.48	0.39	36.9	615.6	46.5	1.65	17.06
B3	42.13	0.62	60.3	542.8	41.0	2.44	9.89
B4	65.31	0.36	34.6	636.0	48.1	1.60	14.54
B5	80.72	0.42	39.7	618.8	46.8	1.72	18.02
B6	36.27	0.56	53.8	604.0	45.7	2.21	8.13
B7	160.52	0.18	17.1	586.8	44.4	1.27	35.93

¹ Related to the gross area. RES-S, renewable energy sources—solar.

As seen in Table 6, the performance indicators achieved by a hybrid heating system as per the efficiency criteria can be conflicting, for example:

- The B3 system, characterized by the maximum solar fraction, achieves low values of efficiencies related to the collector field (E_{fc}^a , η_c) and high values of the global efficiency of the hybrid heating system (E_f^a), respectively, of RES use efficiency in building (I_{RES}^a);
- Highest values of yield, η_c , and E_{fc}^a were obtained in the case of residential buildings with the highest dhw consumptions, compared to administrative, commercial, and industrial buildings.

In order to resolve the conflicting situations, a hierarchical multicriteria analysis process was carried out. The process infers the prioritization and weighting of the criteria according to their importance with respect to overall efficiency ranking.

4. Multicriteria Hierarchical Method

4.1. Method Description

From a strategic perspective, the decision-making process is one of the most important and challenging phases of management. An organization's resources are always limited compared to the ideas and perspectives of its members, therefore the CEOs have to choose the most valuable alternative from several proposals. Experience and common sense are not options when financial and human resources or prestige is involved. Therefore, the managers should make the best decision based on tangible or intangible criteria [31].

AHP (analytic hierarchy process) is a decision-making process that develops a mathematical model for prioritizing projects based on more criteria that can be applied to all projects [43]. It was invented by Thomas Saaty during the 1970s for decision-making in a complex economical environment, where there are several variables and criteria. They have to be prioritized and based on results, the best solution will be chosen. The starting point of the problem solving is that, even if several criteria are determined, their weights may be not equal. Therefore, each of them has an amount of importance, compared to all the others (pairwise comparison) [44].

AHP phases can be represented as in Figure 5. First, the problem is analyzed and decomposed in a set of criteria. Then a pairwise comparison is developed by using an evaluation scale and for each criterion a numerical weight is computed, which is the base for criteria ranking. After checking the consistency of the matrix, the algorithm shows the chance of each alternative to fulfill the objectives. Saaty proposed an evaluation scale with numbers from 1 to 9 (Table 7) for determining the relative importance of each alternative compared to the others [45]. The network model used in the hierarchical analysis process is shown in Figure 5.

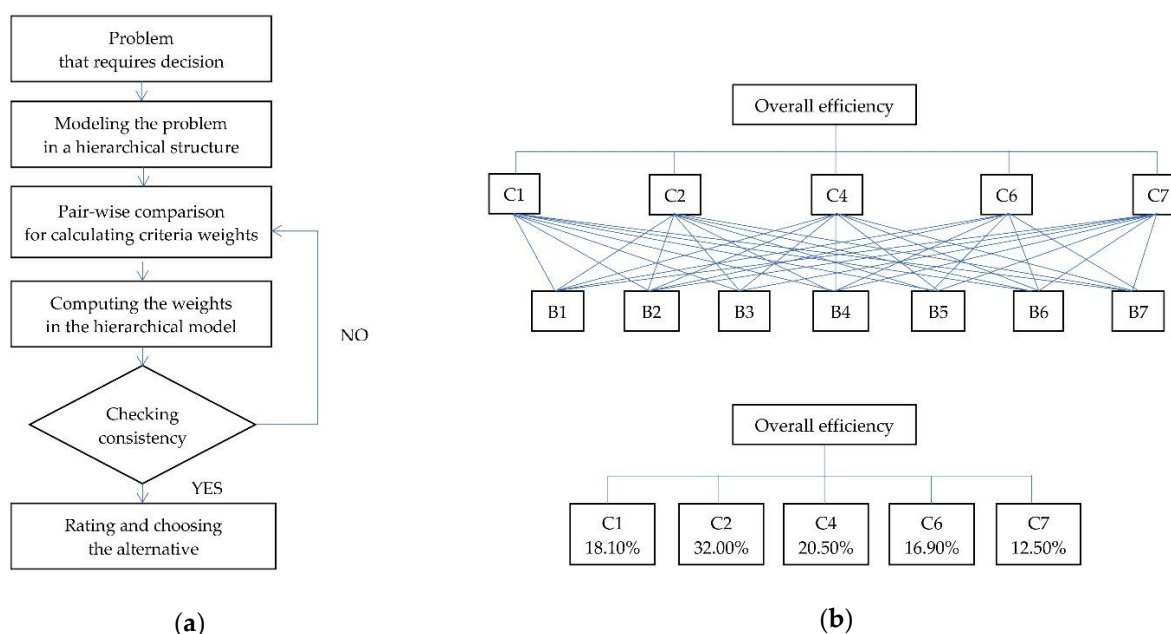

Figure 5. (a) Hierarchical ranking network; (b) criteria weights regarding overall efficiency.

Table 7. Evaluation scale by Saaty.

No.	Relative Importance
1	Equal importance
3	Moderate importance
5	Big importance
7	Very big importance
9	Extreme importance
2, 4, 6, 8	Intermediate values
1/3, 1/5, 1/7, 1/9	Values for reverse comparison

4.2. Overall Efficiency Ranking

Based on the Saaty scale, the criteria are pairwise compared (Table 8). An important step is to calculate the importance of each criterion (C1, C2, C4, C6, C7), to the overall efficiency, by using the Eigenvector, which shows the relative weight of each criterion.

The weight of each element of the matrix in the sum of the criterion is listed in Figure 5 and Table 9. The consistency matrix is listed in Table 9.

Table 8. Pairwise comparison matrix with respect to the goal—overall efficiency.

Criteria	C1	C2	C4	C6	C7	Weight, $k_{w,j}$ [%]
C1	1	1/5	1/5	1/7	3	6.57
C2	5	1	3	1/3	7	21.95
C4	5	1/3	1	1/5	3	16.30
C6	7	3	5	1	9	34.66
C7	1/3	1/7	1/3	1/9	1	15.68
Sum	18.3333	4.6761	9.5333	1.7872	23.0000	100.00

Table 9. Matrix of consistency.

	C1	C2	C4	C6	C7	Sum of Rates
C1	0.0657	0.0517	0.0276	0.0715	0.1140	0.3305
C2	0.3285	0.2584	0.4146	0.1664	0.2660	1.4339
C4	0.3285	0.0860	0.1382	0.0999	0.1140	0.7666
C6	0.4599	0.7752	0.6910	0.4997	0.3420	2.7678
C7	0.0219	0.0370	0.0460	0.0555	0.0380	0.1984
Weight	0.0657	0.2584	0.1382	0.4997	0.0380	1.0000
Order	4	2	3	1	5	1–5

The consistency index, CI , can be determined by Relation (9) and the consistency rate, CR , by Relation (10) as follows.

$$CI = \frac{y_{max} - n}{n - 1} \quad (9)$$

where n is the number of the elements (criteria) to compare and y_{max} is the eigenvalue.

$$CR = \frac{CI}{RI} \quad (10)$$

where RI is the random index.

The Saaty table with random index for ten variables is as follows in Table 10.

Table 10. Random index by Saaty.

Matrix	1	2	3	4	5	6	7	8	9	10
RI	0.00	0.00	0.58	0.90	1.12	1.24	1.32	1.41	1.45	1.49

According to Saaty, the consistency index should be less than 10%. As can be seen, RI is 1.12 and $CR = 8.42\% < 10\%$. It means that the matrix is consistent. The ranked alternatives were centralized in Tables 11 and 12.

Table 11. Criteria and alternatives matrix.

Criterion	Order	Weight	Alternative							
			B1	B2	B3	B4	B5	B6	B7	
C_j	-	$k_{w,j}$								
C1	4	0.0657	0.95	0.47	0.86	0.56	0.45	1	0.23	
C2	2	0.2584	0.74	0.63	1	0.58	0.68	0.90	0.29	
C4	3	0.1382	0.66	0.97	0.85	1	0.97	0.95	0.92	
C5	-	-	0.66	0.97	0.85	1	0.97	0.95	0.92	
C6	1	0.4997	0.72	0.68	1	0.66	0.70	0.91	0.52	
C7	5	0.0380	0.94	0.48	0.82	0.56	0.45	1	0.23	

Table 12. Weighted alternatives matrix.

Alternative	$k_{w,i} \cdot k_{w,j}$					Sum	Rank
B1	0.0624	0.1912	0.0912	0.3598	0.0357	0.740	3
B2	0.0309	0.1628	0.1341	0.3398	0.0182	0.686	5
B3	0.0565	0.2584	0.1175	0.4997	0.0312	0.963	2
B4	0.0368	0.1499	0.1382	0.3298	0.0213	0.676	6
B5	0.0296	0.1757	0.1341	0.3498	0.0171	0.706	4
B6	0.0657	0.2326	0.1313	0.4547	0.0380	1.141	1
B7	0.0151	0.0749	0.1271	0.2598	0.0087	0.486	7

5. Results

Alternatives B1–B7 were ranked by each criterion as well as by the achieved overall efficiency based on multicriteria analyses, within the hierarchical analysis process, AHP. The hierarchy obtained is shown in Table 13 and Figure 6.

Table 13. Ranking alternatives.

Alternative	Ranking Criteria							Overall Efficiency
	C1	C2	C3	C4	C5	C6	C7	
B1	2	3	3	7	7	3	2	3
B2	4	5	5	3	3	5	5	5
B3	3	1	1	6	6	1	3	2
B4	5	6	6	1	1	6	4	6
B5	6	4	4	2	2	4	6	4
B6	1	2	2	4	4	2	1	1
B7	7	7	7	5	5	7	7	7

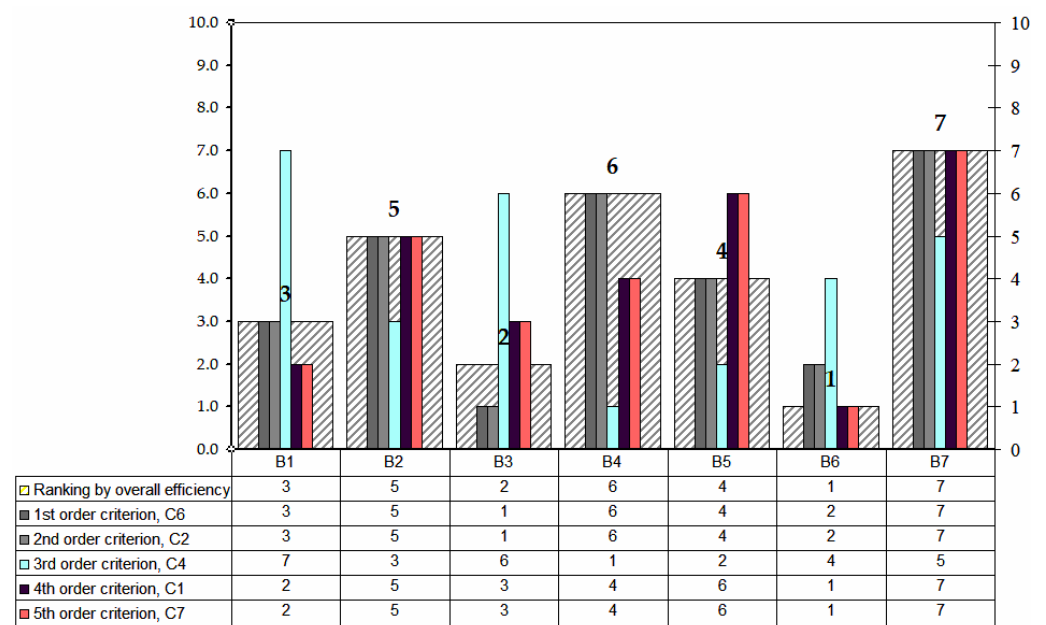
**Figure 6.** Ranking by overall efficiency.

6. Conclusions

Decentralized integration of hybrid systems allowed the existing thermal consumers to use RES-S at the desired coverage rates, restricted by the existing available mounting areas for solar fields, under conditions of high energy efficiencies. Decentralized integration of RES-S systems allowed to reduce the heating period with respect to conventional heating

source with up to three months of operation, respectively ensuring domestic hot water consumption in the spring–summer period up to 100%, depending on the achievable solar fraction and storage volume. The followings can be noticed in Table 13 and Figure 6:

- Achieving high annual solar field efficiency (C4) leads to low levels of the global energy efficiency of the hybrid heating systems (C6); B4 with $E_{fc}^a = 636.0$ kWh/(m² year) and $E_f^a = 1.60$, followed by B5 with $E_{fc}^a = 618.8$ kWh/(m² year) and $E_f^a = 1.72$. From this perspective (C6), the optimal choice seems to be B3 ($E_f^a = 2.44$) followed by B6 ($E_f^a = 2.21$);
- Ranking scenarios by global energy efficiency of the hybrid heating systems (C6) does not always coincide with the rank by specific indicator of equivalent emissions (C7). Pursuant to C7, B6 ($e_{mCO_2} = 8.13$ kgCO₂/(m² year)) and B1 ($e_{mCO_2} = 8.68$ kgCO₂/(m² year)) ranks ahead of B3 ($e_{mCO_2} = 9.89$ kgCO₂/(m² year)). In this perspective, the optimal choice seems to be B6;
- Ranking scenarios by overall efficiency leads to residential buildings characterized by high dhw consumptions, B6 followed by B3;
- Ranking scenarios by overall efficiency leads to the B6 as a first scenario, a residential building characterized by the lowest compactness ratio (0.25 m⁻¹);
- It can be seen that the ranking by overall efficiency coincides with the ranking by specific indicator of equivalent emissions (C7), and the best environmental performances are achieved in the case of the best ranked scenario, validated by AHP.

It can be concluded that, in the case of the decentralized integration of solar thermal systems, the annual efficiency of RES-S use in administrative, commercial buildings, etc. is low in relation to the annual efficiency of RES-S use obtained for residential buildings. The main factors in establishing the overall efficiency of the heating systems are, within the limits of the present experiment, the designation of the building, the built density, and the constructive aspects such as the compactness ratio. Furthermore, the study is applicable to urban areas, with similar constructive and functional characteristics (built and thermal energy density, energy consumptions, etc.), connected to the district heating networks. Taking into account the specific performance indicators (e.g., reported to areas, number of occupants, etc.) and similar configurations of the hybrid heating systems, the study can be extended to urban areas with different values of the thermal energy density.

Author Contributions: Conceptualization and methodology, T.M.Š.; data curation and validation, T.M.Š. and L.A.; formal analysis, L.M.M., D.L.M., and Č.Z.; investigation and resources, T.M.Š.; writing—original draft preparation, T.M.Š.; writing—review and editing, T.M.Š., L.M.M., and L.A.; visualization and supervision, D.L.M., A.C., and Č.Z. All authors have read and agreed to the published version of the manuscript.

Funding: This research received no external funding.

Institutional Review Board Statement: Not applicable.

Informed Consent Statement: Not applicable.

Data Availability Statement: All data have been included in this paper.

Conflicts of Interest: The authors declare no conflict of interest.

Abbreviations

AHP	analytic hierarchy process
ANP	analytic network process
DHS	district heating system
dhw	domestic hot water
energy _e	electric energy
energy _t	thermal energy
nZEB	nearly zero-energy building
RES	renewable energy sources
RES-S	renewable energy sources–solar

Nomenclature

A_a	aperture area of the solar collector field (m ²)
A_h	heated area of the building (m ²)
A_c	gross area of the solar collector field (m ²)
CI	consistency index (-)
CR	consistency rate (-)
$E_{del,i,j}$	final energy, annually delivered to the building, related to the renewable energy source/conventional fuel of type “i”, “j” (kWh/year)
$E_{exp,i,j}$	annually on-site generated energy, at the level of building or nearby, and redirected into the district heating system, related to the renewable energy/conventional fuel of type “i”, “j” (kWh/year)
E_f^a	annual global energy efficiency of the hybrid heating system (-)
E_{fc}^a	solar collector field efficiency (kWh/(m ² year))
$E_{conv,j}$	annual energy, delivered to the building from conventional energy sources of type “j” (kWh/year)
e_{mCO_2}	specific indicator of equivalent emissions (kgCO _{2equiv.} /(m ² year))
E_p	annual consumption of electricity (pumping, automation, and control system) (kWh/year)
E_{pconv}	annual consumption of primary energy (electricity and fuels energy) of the conventional heating sources (kWh/year)
E_{pconv}^a	indicator of annual conventional primary energy (kWh/(m ² year))
$E_{pconv,j}$	annual consumptions of primary conventional energy type “j”, electricity and fuels energy (kWh/year)
E_{pRES}	annual primary energy, obtained from renewables and used in the building (kWh/year)
$f_{CO_2,j}$	CO _{2equiv.} emission factor, related to the energy type “j” (kgCO _{2equiv.} /kWh)
$f_{i,j}$	conversion factor into the primary energy, of the final energy of type “i”, “j” (-)
F_S^a	annual solar fraction (%)
G	global coefficient of thermal insulation of building (W/(m ³ K))
I_b	direct solar irradiation on the collector area (kWh/year)
I_c	irradiation onto the collector area (MWh/year)
I_d	diffuse irradiation normal on the tilted surface of the collector (kWh/year)
I_r	reflected irradiation normal on the tilted surface of the collector (kWh/year)
I_{RES}^a	indicator of RES harnessing in building (-)
$I_{s,equiv.}$	indicator of equivalent area (-)
$k_{w,i}, k_{w,j}$	weight coefficients (%)
Q_{conv}^a	annual conventional energy to the system (kWh/year)
$Q_{feed-in}$	Energy, annually delivered into the district heating network, consisting in excess energy generated by solar resource (kWh/year)
q_h^a	annual specific thermal energy consumption for space heating, ventilation and dhw (kWh/(m ² year))

Q_h^a	annual thermal energy demand/consumption for space heating, ventilation, and dhw (MWh/year)
Q_{RES}^a	annual thermal energy related to RES (kWh/year)
Q_s^a	annual solar thermal energy to the system (kWh/year)
R_b	ratio of beam radiation on the tilted surface to that on a horizontal surface; the geometric factor (-)
RI	random index (-)
t_{ex}	outdoor conventional temperature for heating (°C)
α_{RES}^a	RES participation in the thermoenergetic system (%)
β	tilt angle of the collector (°)
η_c	solar collector yield (%)
y_{max}	eigenvalue (-)
ρ	albedo coefficient (-)

References

- International Energy Agency (IEA). Data and Statistics. Available online: www.iea.org/data-and-statistics (accessed on 14 August 2020).
- National Energy Regulatory Authority (ANRE). Report Regarding the Results of the Electricity Market Monitoring in December 2019. Available online: www.anre.ro (accessed on 14 August 2020).
- International Energy Agency (IEA). World Energy Outlook. 2019. Available online: <https://www.iea.org/reports/world-energy-outlook-2019> (accessed on 21 July 2020).
- Eurostat. Energy, Transport and Environment Indicators. 2018. Available online: <https://ec.europa.eu/Eurostat> (accessed on 22 July 2020).
- Eurostat. Energy, Transport and Environment Statistics. 2019. Available online: <https://ec.europa.eu/Eurostat> (accessed on 22 July 2020).
- Eurostat. Manual for Statistics on Energy Consumption in Households. Available online: <https://ec.europa.eu/Eurostat> (accessed on 22 July 2020).
- Ministry of Energy. *Strategy of Romania 2016–2030 with the Perspective of the Year 2050*; Ministry of Energy: Bucharest, Romania, 2016. Available online: <https://energie.gov.ro> (accessed on 22 July 2020).
- Zeljковиć, Č.; Mršić, P.; Erceg, B. Simulation Based Energy Assessment of PV Systems Installed in an Urban Environment. In Proceedings of the 20th International Symposium Power Electronics, Novi Sad, Serbia, 23–26 October 2019.
- Atănașoae, P. Technical and Economic Assessment of Micro-Cogeneration Systems for Residential Applications. *Sustainability* **2020**, *12*, 1074. [[CrossRef](#)]
- Qerimi, D.; Dimitrieska, C.; Vasilevska, S.; Rrecaj, A. Modeling of the Solar Thermal Energy Use in Urban Areas. *Civ. Eng. J.* **2020**, *6*, 1349–1367. [[CrossRef](#)]
- Paraschiv, S.; Nicoleta Bărbuță-Mișu, N.; Paraschiv, L.S. Technical and economic analysis of a solar air heating system integration in a residential building wall to increase energy efficiency by solar heat gain and thermal insulation. *Energy Rep.* **2020**, *6*. [[CrossRef](#)]
- Buildings Performance Institute Europe. *Renovation of Romania*. In *A Strategy for the Sustainable Renovation of the Buildings Fund in Romania*; BPIE: Brussels, Belgium, 2014; Available online: www.bpie.eu (accessed on 14 August 2020).
- National Institute of Statistics. *Residential Fund. Year 2019*; National Institute of Statistics: Bucharest, Romania, 2020. Available online: <https://insse.ro> (accessed on 14 August 2020).
- Așchilean, I.; Giurca, I. Choosing a water distribution pipe rehabilitation solution using the analytical network process method. *Water* **2018**, *10*, 484. [[CrossRef](#)]
- Chen, Z.; Clements-Croome, D.; Hong, J.; Li, H.; Xu, Q. A multicriteria lifespan energy efficiency approach to intelligent building assessment. *Energy Build.* **2006**, *38*, 393–409. [[CrossRef](#)]
- Cheng, E.; Li, H. Analytic Network Process Applied to Project Selection. *J. Constr. Eng. Manag.* **2005**, *131*, 459–466. [[CrossRef](#)]
- Acıu, C.; Manea, D.L.; Strilețchi, C. The ECCOMAT program for the selection of ecological materials in order to ensure a healthy built environment. *Procedia Technol.* **2015**, *19*, 490–497. [[CrossRef](#)]
- Alyamani, R.; Long, S. The Application of Fuzzy Analytic Hierarchy Process in Sustainable Project Selection. *Sustainability* **2020**, *12*, 8314. [[CrossRef](#)]
- Mardani, A.; Jusoh, A.; Zavadskas, E.K.; Cavallaro, F.; Khalifah, Z. Sustainable and Renewable Energy: An Overview of the Application of Multiple Criteria Decision Making Techniques and Approaches. *Sustainability* **2015**, *7*, 13497–13984. [[CrossRef](#)]
- Abdelazim, A.; Ibrahim, A.; Aboul-Zahab, E. Development of an energy efficiency rating system for existing buildings using Analytic Hierarchy Process—The case of Egypt. *Renew. Sust. Energy Rev.* **2017**, *71*, 414–425. [[CrossRef](#)]
- Doczy, R.; AbdelRazig, Y. Green Buildings Case Study Analysis Using AHP and MAUT in Sustainability and Costs. *J. Archit. Eng.* **2017**, *23*. [[CrossRef](#)]

22. Hatefi, S.M. Intelligent Building Assessment Based on an Integrated Model of Fuzzy Analytic Hierarchy Process and Fuzzy Preference Degree Approach (FAHP-FPDA). *Int. J. Optim. Civ. Eng.* **2019**, *9*, 79–92.
23. Xu, L.; Yang, J.-B. *Introduction to Multi-Criteria Decision Making and the Evidential Reasoning Approach*; Working Paper No. 0106; Manchester School of Management: Manchester, UK, 2001; ISBN 186115111X.
24. Zarchi, A.K.; Marthandan, G.; Eshaghi, M. An Analytical Hierarchically Process (AHP) based Approach for Promoting Green Buildings among the Citizens of Next Generation in Malaysia. In Proceedings of the 2012 International Conference on Economics, Business and Marketing Management, Singapore, 26–28 February 2012; IACSIT Press: Singapore, 2012; pp. 88–93.
25. Erdogmus, S.; Aras, H.; Koç, E. Evaluation of alternative fuels for residential heating in Turkey using analytic network process (ANP) with group decision-making. *Renew. Sustain. Energy Rev.* **2006**, *10*, 269–279. [[CrossRef](#)]
26. Erdogan, S.; Sayin, C. Selection of the Most Suitable Alternative Fuel Depending on the Fuel Characteristics and Price by the Hybrid MCDM Method. *Sustainability* **2018**, *10*, 1583. [[CrossRef](#)]
27. Giurca, I.; Badea, G.; Aşchilean, I.; Naghiu, G.S.; Megyesi, E. Selecting the number and size of boilers used within the heating units of the residential complexes. *Energy Procedia* **2017**, *112*, 134–141. [[CrossRef](#)]
28. Hatefi, S.M.; Tamošaitienė, J. Construction Projects Assessment Based on the Sustainable Development Criteria by an Integrated Fuzzy AHP and Improved GRA Model. *Sustainability* **2018**, *10*, 991. [[CrossRef](#)]
29. Şoimoşan, T.M.; Moga, L.M.; Danku, G.; Căzilă, A.; Manea, D.L. Assessing the Energy Performance of Solar Thermal Energy for Heat Production in Urban Areas: A case study. *Energies* **2019**, *12*, 1088. [[CrossRef](#)]
30. Saaty, T.L. Decision making with the analytic hierarchy process. *Int. J. Serv.* **2008**, *1*. [[CrossRef](#)]
31. Saaty, T.L. Relative Measurement and its Generalization in Decision Making: Why Pairwise Comparisons are Central in Mathematics for the Measurement of Intangible Factors—The Analytic Hierarchy/Network Process. *Madr. Rev. R. Span. Acad. Sci. Ser. A Math.* **2008**, *102*, 251–318. Available online: <http://www.rac.es/ficheros/doc/00576.PDF> (accessed on 5 January 2021). [[CrossRef](#)]
32. ASRO. Heating installations. Heating demand calculation. In *Romanian Standard Indicative SR 1907-1,2/2014*; Rev. 2016; ASRO: Bucharest, Romania, 2016.
33. Ministerul Dezvoltării Regionale și Turismului. *Standard Regarding Thermotechnical Calculation of Construction Elements of the Building*; Completed by Ord. no. 2513/2010; Ministerul Dezvoltării Regionale și Turismului: București, Romania, 2011.
34. Şoimoşan, T.M.; Felseghi, R.A. Efficient Solar Technique for Buildings Connected to the District Heating System. Indicators of Performance. In Proceedings of the 16th International Multidisciplinary Scientific GeoConference SGEM Vienna GREEN 2016, Vienna, Austria, 30 June–6 July 2016.
35. Basemap Open Source ESRI. Available online: www.esri.com (accessed on 6 January 2021).
36. Moga, L.; Moga, I. Analytic study of thermal bridges met at high performance energy efficient buildings. In Proceedings of the 18th International Multidisciplinary Scientific GeoConference SGEM2018, Albena, Bulgaria, 30 June–9 July 2018.
37. Moga, L. Thermal performance of insulating glazing units established by infrared thermography. *IOP Conf. Ser. Mater. Sci. Eng.* **2019**, *586*, 1–8. [[CrossRef](#)]
38. Romanian Ministry of Transport, Construction and Tourism. *Calculation Methodology of the Energy Performance of Buildings, Indicative Mc 001-2006*; Official Monitor: Bucharest, Romania, 2006.
39. Atmospheric Science Data Center (ASDC). Surface Meteorology and Solar Energy, RETScreen Report. 2015. Available online: earthdata.nasa.gov (accessed on 31 August 2015).
40. Vela Solaris AG. *Polysun Designer*; Vela Solaris AG: Winthertur, Switzerland, 2020.
41. Duffie, J.A.; Beckman, W.A. *Solar Engineering of Thermal Processes*, 4th ed.; Solar Energy Laboratory, University of Wisconsin-Madison; John Wiley & Sons, Inc.: Hoboken, NJ, USA, 2013.
42. Ordinance no. 2641/2017. Monitorul Oficial. 2017. Available online: <http://www.aacrr.ro/wp-content/uploads/2017/04/normele-privind-calculul-performantei-energetice-a-cladirilor.pdf> (accessed on 14 August 2020).
43. Vargas, R.V. Using the analytic hierarchy process (ahp) to select and prioritize projects in a portfolio. In Proceedings of the PMI® Global Congress 2010, Washington, DC, USA, 9–12 October 2010.
44. Ho, W.; Ma, X. The state-of-the-art integrations and applications of the analytic hierarchy process. *Eur. J. Oper. Res.* **2018**, *267*, 399–414. [[CrossRef](#)]
45. Saaty, T.L. *The Analytic Hierarchy Process: Planning, Priority Setting, Resource Allocation*. In *Multicriteria Decision Making*; McGraw Hill: New York, NY, USA, 1980.