

Article

A Study on the Safety Evaluation of Escape Routes for Vulnerable Populations in Residential Facilities

Chansol Ahn ¹, Hyeongwoo Kim ² , Insu Choi ² and Dongho Rie ^{3,*} 

¹ Department of Fire Safety Research, Korea Institute of Civil Engineering and Building Technology, Goyang 18544, Korea; chansole@kict.re.kr

² Department of Safety Engineering, Incheon National University, Incheon 22012, Korea; khw1950@inu.ac.kr (H.K.); z9447z@inu.ac.kr (I.C.)

³ Fire Disaster Prevention Research Center of Safety Engineering, Incheon National University, Incheon 22012, Korea

* Correspondence: riedh@inu.ac.kr; Tel.: +82-32-835-8293

Abstract: The continued increase in human lifespans is accelerating the aging of the population in most countries. The increase in elderly care facilities corresponds to a relative increase in the number of people who are vulnerable in the context of evacuation. For example, an elderly care hospital is a representative facility for vulnerable populations as regards evacuation, as residents in such a hospital cannot evacuate themselves in the event of a fire. It is therefore necessary for such buildings to formulate detailed evacuation plans that consider the walking situations of their residents in the event of a disaster. In this study, the fire dynamics simulator (FDS) was used to calculate the available safety escape time (ASET)—which is the point at which evacuation is impossible from the ignition time of the fire—for inpatients in nursing hospitals. The required safety escape time (RSET), which is the time required to move to a safe place, was calculated by reflecting a patient's evacuation speed using Pathfinder. In addition, the evacuation route was simulated with three variables—stairs, elevators, and ramps—along with the movement pattern. The simulations of evacuation performance evaluation based on time analysis showed that there were differences in the number of fatalities depending on the choice of evacuation routes and movement patterns for each disabled group. Evacuation using ramps was confirmed to reduce fatalities from at least 48 to up to 60 people compared to evacuation using stairs or elevators. The usage of ramp evacuation in elderly care hospitals has proved to be superior to other evacuation routes in ensuring the safety of vulnerable persons during fire evacuation.



Citation: Ahn, C.; Kim, H.; Choi, I.; Rie, D. A Study on the Safety Evaluation of Escape Routes for Vulnerable Populations in Residential Facilities. *Sustainability* **2022**, *14*, 5998. <https://doi.org/10.3390/su14105998>

Academic Editor: Salvador García-Ayllón Veintimilla

Received: 12 March 2022

Accepted: 11 May 2022

Published: 15 May 2022

Publisher's Note: MDPI stays neutral with regard to jurisdictional claims in published maps and institutional affiliations.



Copyright: © 2022 by the authors. Licensee MDPI, Basel, Switzerland. This article is an open access article distributed under the terms and conditions of the Creative Commons Attribution (CC BY) license (<https://creativecommons.org/licenses/by/4.0/>).

Keywords: elderly care hospital; fire safety; evacuation route; fatality

1. Introduction

The continued increase in human lifespans is accelerating the aging of the population in most countries, and the number of people aged 65 and over worldwide is expected to double from 73 million in 2019 to 150 million by 2050 [1].

In Korea, a society with a population aged 65 or older accounting for more than 14% of the total population, is called an aging society, and a society with more than 20% is called a super-aged society. As of 2020, 15.7% of the population is over the age of 65, meaning that the nation has become an aging society, and by 2025, the proportion of the elderly will exceed 20%, at which point it is expected to become a super-aged society [2]. Therefore, continued increases in the proportion of the elderly population are leading to corresponding increases in the numbers of residential aged care facilities (RACF) and care hospitals. Elderly people living in these facilities generally have geriatric diseases as well as restricted mobility, and thus they cannot evacuate on their own in the event of a disaster such as a fire; this poses a serious safety risk.

In Korea, there were 27 casualties in the fire accident at the Indeok Nursing Home in Pohang in 2010 [3], and the fire at the Jangseong Filial Love Sharing Nursing Hospital in 2014 caused 29 casualties [4]. In 2018, there was a large fire disaster at Miryang Sejong Nursing Hospital that killed 39 people and injured 151 people [5]. Table 1 presents fire accidents that have occurred in nursing facilities in different countries.

Table 1. Examples of fire cases from overseas elderly care hospitals.

Date	Casualties	Fire Location	Country
18 November 2011	Death: 5; Injury: 30	Quakers Hill nursing home	Australia [6]
23 January 2014	Death: 32	Elderly care facility	Canada [7]
25 January 2015	Death: 38; Injury: 6	Private nursing home	China [8]
29 May 2016	Death: 17; Injury: 5	Nursing home in Kiev	Ukraine [9]
8 April 2017	Death: 2; Injury: 3	Elderly nursing home in Hertfordshire	UK [10]
16 November 2017	Injury: 20	Barclay friends senior nursing facility	USA [11]
18 January 2018	Injury: 6	Old Vicarage home	UK [12]
31 January 2018	Death: 11; Injury: 3	Sapporo city elderly livelihood security beneficiary self-support facility	Japan [13]
21 January 2021	Death: 15; Injury: 11	Kharkiv nursing home	Ukraine [14]
24 March 2021	Death: 2	New York evergreen court home nursing home	USA [15]

Residents of such facilities may suffer greater damage from fires than the general population due to geriatric diseases and limited mobility; it is therefore crucial that such facilities have efficient evacuation methods that are suitable for their residents, and it is also necessary to improve shelter equipment.

In a related study, Lee and Heo using fire and evacuation simulation to compare the required safety escape time (RSET) and the available safety escape time (ASET) in nursing hospitals to determine the safety of evacuation inducers in terms of legal standards [16].

Kim et al. calculated the evacuation time by applying a fire simulation to elderly care hospitals, and they reported that the evacuation time could be reduced by establishing separate fire safety standards for day and night protection, which they determined using Simulx [17].

Jeon et al. suggested a plan for reducing the evacuation time depending on the situation—such as whether the sprinkler or fire door is closed—using Pyrosim and Pathfinder for elderly medical welfare facilities [18].

Rie et al. quantitatively compared ASET and RSET by providing an information transfer function between agents by using artistic simulation that enables bypass evacuation according to the risk and that also allows for the evacuation route and evacuation start time to be individually set for each evacuee [19].

Mufeng Xiao et al. reported that the evacuation time could be reduced through evacuation guidance by applying the physical characteristics of library occupants as well as the movement speed that reflects these characteristics by using Pathfinder [20].

Evacuation times in high-rise buildings were studied using Pathfinder by Boonngam and Patvichaichod. They reported that when the passenger elevator was used as a fire escape elevator, the efficiency of evacuation performance increased from 29.21% to 35.05% [21].

In Hunt et al. an algorithm that considers both horizontal and vertical evacuation at the same time using Pathfinder and Exodus is presented [22].

According to Anastasios et al., in the case of fire, the smoke reduces the maximum movement speed of the occupants and increases the minimum movement speed [23].

Hospitals do not have common evacuation guidelines, even in various publications, reports, and conclusions, and lack adequate preparation. It has been suggested that nationality cooperation is necessary for the joint use of these evacuation plans and guidelines by trade unions and the international community [24].

The optimum reduction in evacuation time to minimize damage to human life caused by fire is determined based on the characteristics of the residents and the evacuation routes. In Korea, the enforcement regulations of the Elderly Welfare Act stipulate that a ramp should be installed in all elderly care hospitals [25]. However, the installation of such ramps is excluded from the mandatory requirements if the elevator installation conditions of the Domestic Elevator Facility Safety Management Act are satisfied.

Groups that are vulnerable during egress (e.g., residents of elderly nursing hospitals, nursing homes, etc.) need to be clearly presented with appropriate evacuation routes and methods to reduce evacuation time. In this study, through quantitative analysis of evacuation times by evacuation route (stair stairs, elevators, ramps, etc.), suitable evacuation routes are presented for facilities for vulnerable groups during egress. In addition, this analysis was performed using a coupling method using FDS and Pathfinder, which are simulations of fire and evacuation, to suggest ways to reduce evacuation time through the classification of patient groups.

2. Analysis of Predicting Fatality by Evacuation Method

The safety evaluation applied to this study reflected the reduction in evacuation time due to reduced visibility as well as increased temperature, CO, CO₂, and smoke caused by a fire in real-time evacuation sites. Figure 1 shows the flow chart of the study.

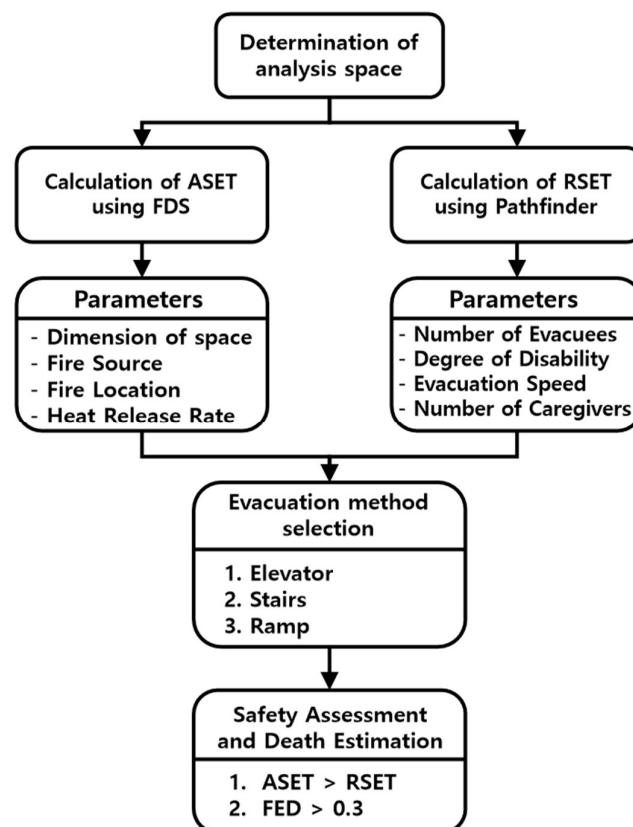

Figure 1. Analysis flow chart.

2.1. Evaluation of ASET and RSET

In this evaluation, the fire dynamics simulator (FDS) was used for ASET analysis, and the Pathfinder 2019 version [26,27] was used for RSET analysis. FDS is a computational fluid dynamics model of fire-driven fluid flow provided by the National Institute of Standards and Technology (NIST) of the US Department of Commerce and is a free open-source software. FDS is a computational fluid dynamics software for fire-driven fluid flows that numerically solves the form of Navier–Stokes equations suitable for low-velocity heat-driven flows and also solves smoke and heat transfer problems due to fire. Pathfinder is an

agent-based software that uses 3D analysis to measure the route and time for a person in a room to evacuate to an exit. Therefore, this study used Pathfinder to perform an evacuation simulation, including congestion-based pedestrian movement characteristics.

Evacuation risk assessment was conducted by comparing the RSET time required to evacuate from a fire site with the ASET defined as the time it takes for fire effluents to reach the human body. Equation (1) shows the conditions for securing safety obtained by comparing ASET and RSET in this study. Figure 2 shows the time conceptual diagram for ASET and RSET.

$$ASET - RSET > 0 \tag{1}$$

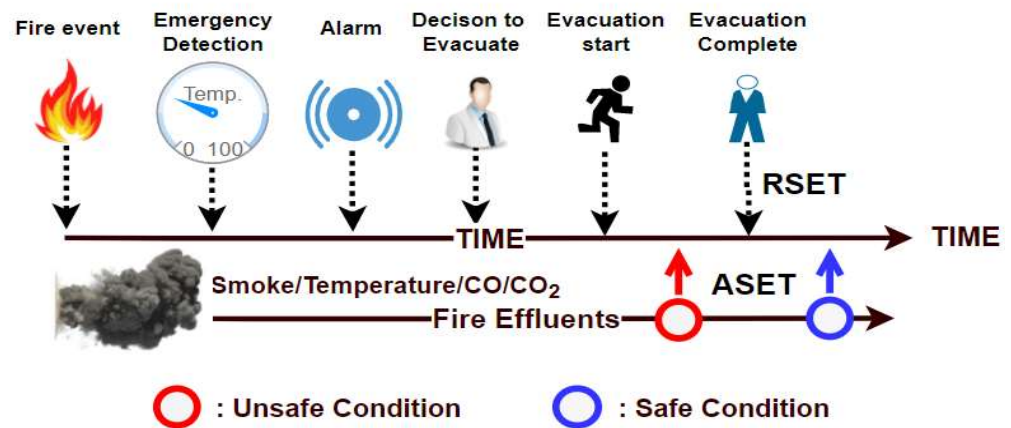

Figure 2. Time conceptual diagram for ASET and REST.

In this study, RSET means the amount of time that is required for occupants to evacuate a fire floor safely using (1) evacuation stairs, (2) elevators, and (3) ramps. Therefore, having a relatively lower RSET value means that the evacuation route is relatively less affected by fire effluents.

2.2. Evacuation Space Model

The target building for the fire hazard with evacuation analysis has different characteristics of usage, fire areas, evacuation methods, and locations of the evacuation route. In this study, circular space modeling was applied, as shown in Figure 3, to simplify the problems of the various spaces and structures of these buildings.

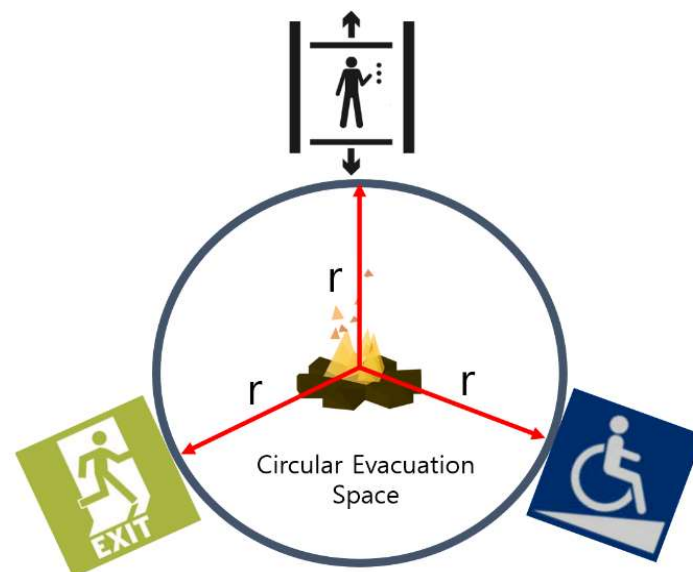

Figure 3. Spatial modeling concept.

The application of this simplified circular space model has the advantage of obtaining a uniform ASET value regardless of the arrangement of the evacuation route entrance located in the circular arc, as the evacuation route can be simplified regardless of the design structure. Figure 4 shows the three-dimensional circular space modeling applied in this study [28].

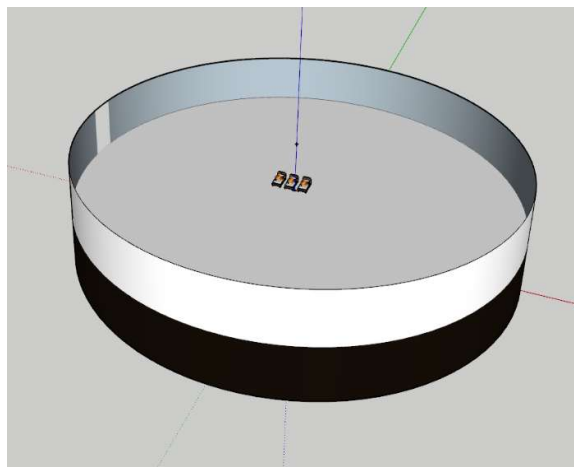

Figure 4. 3D analysis spatial modeling.

2.3. Evacuation Condition

2.3.1. Fire Floor and Evacuation Route

Table 2 shows the fire floor width and radius set upon the Pathfinder and conditions for each evacuation method.

Table 2. Spatial and evacuation conditions.

Fire Floor		Area	2274 m ²	
Evacuation route	Elevator	Capacity	18 Person	
		Running speed	26 s/round trip	
		Width	1.5 m	
	Ramp	Length	4 m	
		Slope	4.76°	
		Width	1.5 m	
		Length	70.59 m	
		Stair	Height	17.78 cm
			Width	1.5 m
Length	8.482 m			

2.3.2. Total Number of Occupants

The area of the modeling space was set to be the same as the 15 open areas of the five-person room in the nursing hospital. The number of occupants was set as 114 persons according to the enforcement regulations of South Korea's Elderly Welfare Act [25].

The patient groups applied for the analysis consisted of (1) non-disabled people, (2) disabled people using canes, (3) disabled people using wheelchairs divided between the patients who used them alone and those who needed a caregiver in the same proportion, and (4) patients with disabilities who are bedridden. The number of moving caregivers for patients with disabilities was set at one caregiver for each patient using a wheelchair and two caregivers for each patient who is bedridden. Table 3 shows the number of people per group and the evacuation delay time.

Table 3. Number of people per group and the evacuation delay time.

Properties	Occupants	Non-Disabled	Disabled with Cane	Wheelchair		Bedridden
				Needed a Caregiver	Alone	
Space density 100% number of people	Patients	114	114	38	38	38
	Caregivers	-	-	38	-	76
	Total	114	114	114		114
Preparation time	For transfer patient	-	-	30 s	-	60 s

2.3.3. Body Dimensions and Sizes of Mattresses and Wheelchairs

The ages were set as 40 to 49 years old for caregivers and non-disabled people, and more than 60 years old for patients. The body dimensions were established by considering the average shoulder width, height, and standard deviation values in anthropometric data from South Korea [29]. The size of the wheelchair was set according to the national standard certification integrated information system (KS P 6113) [30], and the size of the mattress was set according to the value from the Ministry of Food and Drug Safety (2017-16) [31]. Tables 4 and 5 show the applied dimensions for the wheelchair, mattress, and human bodies.

Table 4. Dimensions for the wheelchair and mattress.

Vehicle	Size (m)
Mattress	2 × 1 × 1
Wheelchair	1.004 × 0.7 × 0.875

Table 5. Dimensions for the human body.

Occupants	Average Shoulder Width (m)	Average Height (m)
Non-disabled	0.41	1.70
Caregiver	0.38	1.66
Disabled with cane	0.37	1.57

2.3.4. Evacuation Condition

The evacuation moving speed of the space members is an essential factor in calculating RSET, which is the time required to evacuate from the fire floor to the ground floor. Table 6 shows the moving speed for each patient classification [32,33]. The stair-descending speed was set to 0.5 times the corresponding moving speed on flat ground for each group of patients [34].







Table 6. Moving speed for each patient group.

Space	Group	Moving Speed (m/s)
Flat ground	Non-disabled	1.5
	Bedridden	1.0
	Wheelchair	0.91
	Disabled cane	0.57
Stair	All groups	0.5 times of the flat ground speed

Horizontal evacuation from the fire floor is performed by having assistants help move patients using wheelchairs and patients who are bedridden to the evacuation stairs or the entrance to the evacuation elevator. The movement of the patient on the evacuation stairs—which is a vertical evacuation—is performed by separating the patient from the

wheelchair or mattress and then having the patient descend the stairs with the aid of a caregiver or two caregivers. Table 7 shows the evacuation patterns of each group for each evacuation route in the simulation.

Table 7. Evacuation patterns of each group for each evacuation route.

Group	Elevator and Ramp	Stair
Disabled with cane		
Wheelchair (with caregiver/alone)		
Bedridden		

2.4. Results of RSET

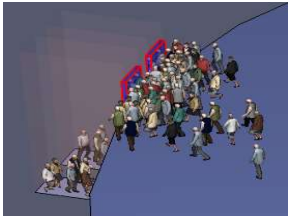

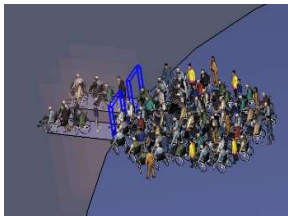
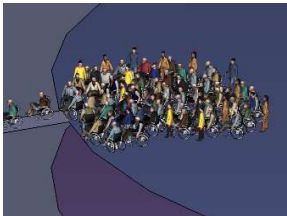

Table 8 shows the bottleneck according to the group evacuation route at the fire floor. The patient transfer of groups of patients using wheelchairs as well as patients who were bedridden under elevator and ramp conditions was identified as the cause of serious bottlenecks at the entrances of evacuation routes. From the 3D evacuation image, it can be seen that, for the stair evacuation of the group made up of patients using wheelchairs and patients who were bedridden, the bottleneck at the entrance of the evacuation route could be reduced by separating the patient from their means of transportation and having them continue on foot with the aid of a caregiver or two caregivers.

Figure 5 shows the number of evacuees on the fire floor according to each group's evacuation route and evacuation time.

In the case of evacuation using stairs (Figure 5a), the group of patients who were bedridden and the group of patients who used wheelchairs showed faster evacuation characteristics than the group of patients who used canes. This is the result of the fastest evacuation when the caregiver helped. Evacuation using the elevator condition (Figure 5b) showed that the group of patients using canes showed faster evacuation characteristics than the group of patients who were bedridden and the group of patients using wheelchairs. This result shows that the number of elevator users increased because the means of mobility assistance (wheelchair, bed, etc.) were not included.

Figure 6 shows the RSET by following each evacuation group.

Table 8. Bottleneck phenomena, according to the group.

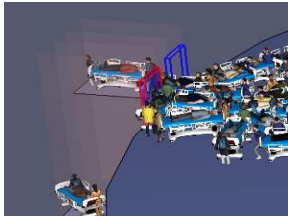
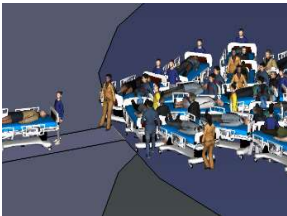
Group	Stair	Elevator	Ramp
Disabled with cane			
Wheelchair			
Bedridden			

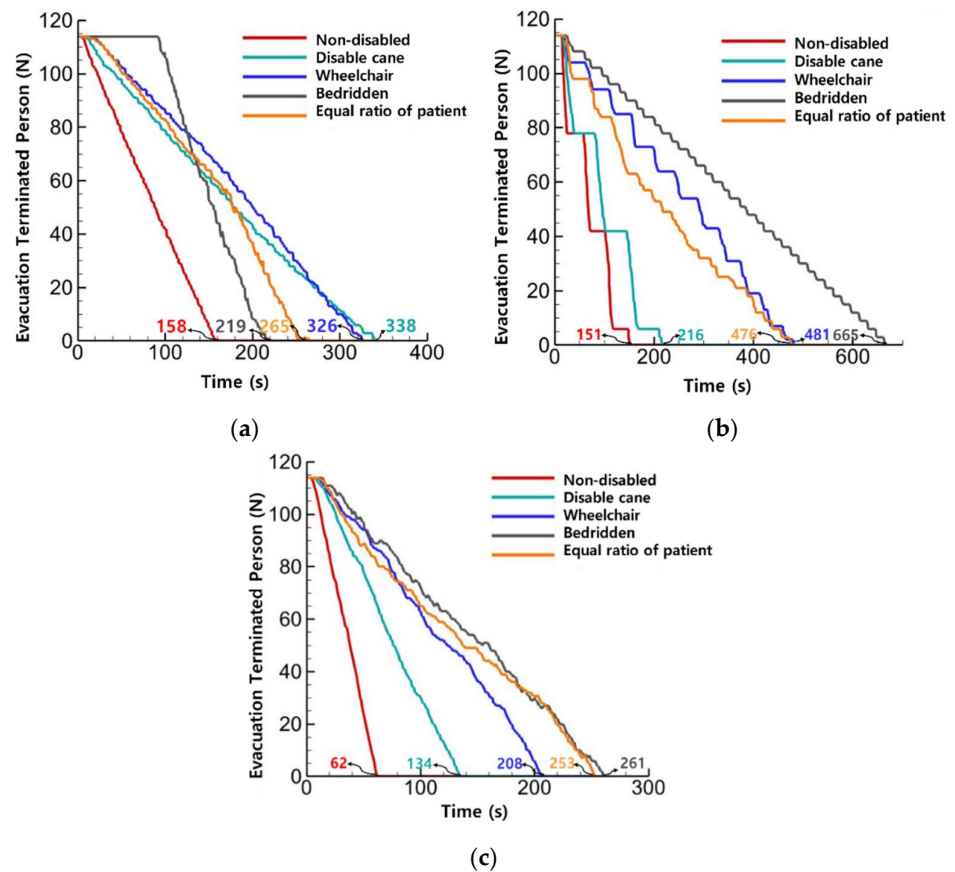

Figure 5. Evacuation time for each evacuation route: (a) stairs-only; (b) elevator-only; (c) ramp-only.

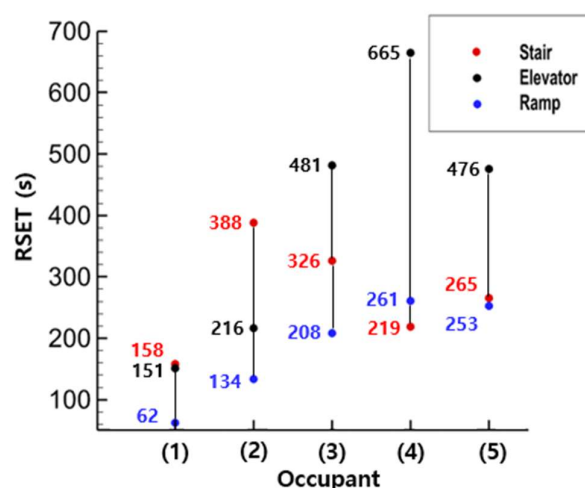

Figure 6. The value of RSET for each group according to the evacuation route.

1. 100% of patients without disabilities;
2. 100% of patients with disabilities who used canes;
3. 100% of patients with disabilities who used wheelchairs;
4. 100% of patients with disabilities who were bedridden;
5. Equal proportions of all patients, i.e., 25% of each of (1) through (4).

The ramp evacuation method showed the shortest RSET—thus appearing as the shortest and most effective evacuation method—under all conditions except for the group of patients who were bedridden (3).

The group of patients with disabilities who used canes (2), moving by their own force, showed the maximum RSET value under the evacuation condition using stairs, and this was found to be the most inefficient evacuation method.

In the group of patients with disabilities who used wheelchairs (3), one caregiver was applied per patient; evacuation using stairs was thus found to be more efficient than that using the elevator.

In the case of the group of patients who were bedridden (4), the condition of stair evacuation was found to have the lowest RSET value with a relatively short evacuation route, as two moving caregivers were deployed per patient.

Under the condition of equal proportions of patients from each group (5), elevator evacuation was found to be the most inefficient method.

3. Risk Assessment

3.1. Fire Scenario

The spatial structure was applied to the ASET analysis in the same way as it was applied to the RSET analysis model. Table 9 presents the input variables applied to the FDS fire scenario to analyze the spatial distribution of fire effluents generated during a fire. A mattress was selected as the fire source, and the number of fire sources was sequentially extended from a minimum of one to a maximum of five. Figure 7 shows the two types of heat release rate diagrams applied to the analysis [34,35].

Table 9. Fire scenario parameters.

Parameter	Value	Specific Condition
Fire duration	900 s	-
Initial temperature	20 °C	Air
Fire source (mattress)	Size (W × D × H) (mm)	1090 × 200 × 2000
	Weight (kg)	21.40
Low heat release rate (Low HRR)	992 kW [35]	Max. peak at 295 s
High heat release rate (High HRR)	1778.95 kW [36]	Max. peak at 245 s
Fire source location	Center	-
Analysis area	2274 m ²	-
Firefighting equipment	Not Working	Ventilation and sprinkler

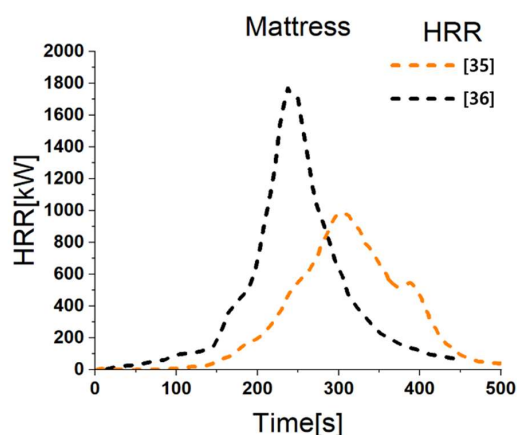
**Figure 7.** Mattress heat release rate.**Table 10.** Performance criteria for life safety at the height of 1.8 m.

Properties		Allowable limit
FED	<	0.3
Temperature limit	<	60 °C
Allowable visibility	>	5 m
CO	<	1400 ppm
O ₂	>	15%
CO ₂	<	5%

As the fatality condition applied in this analysis, the lowest threshold value of FED 0.3 was applied for the most sensitive population group, the elderly, young people, or those with compromised immune systems. The reason why FED was set to 0.3 is that it has been reported that evacuees are incapacitated from the FED value of 0.3 because of the decrease in oxygen due to the inhalation of carbon monoxide and carbon dioxide and insufficient oxygen caused by fire. Therefore, in this study, the point at which this value appeared was judged as the occurrence of casualties. By comparing ASET, which is the time affected by fire effluents in the evacuation route, and the RSET required to move to a safe place, it is possible to quantitatively evaluate the number of deaths among evacuees.

3.2. Spatial Distribution of FED, Visibility, and Temperature

Identifying the spatial distribution of risk assessment items for the entire space of evacuation layer is a very effective method for real-time risk assessment according to evacuee location.

Table 11 shows the FED distribution at 1.8 m above the floor according to the combustion of one to five mattresses up to 300 s at 100 s intervals for the two types of low and high heat release rates (hereafter HRR).

Table 11. FED distributions by the change in fire time at the height of 1.8 m.

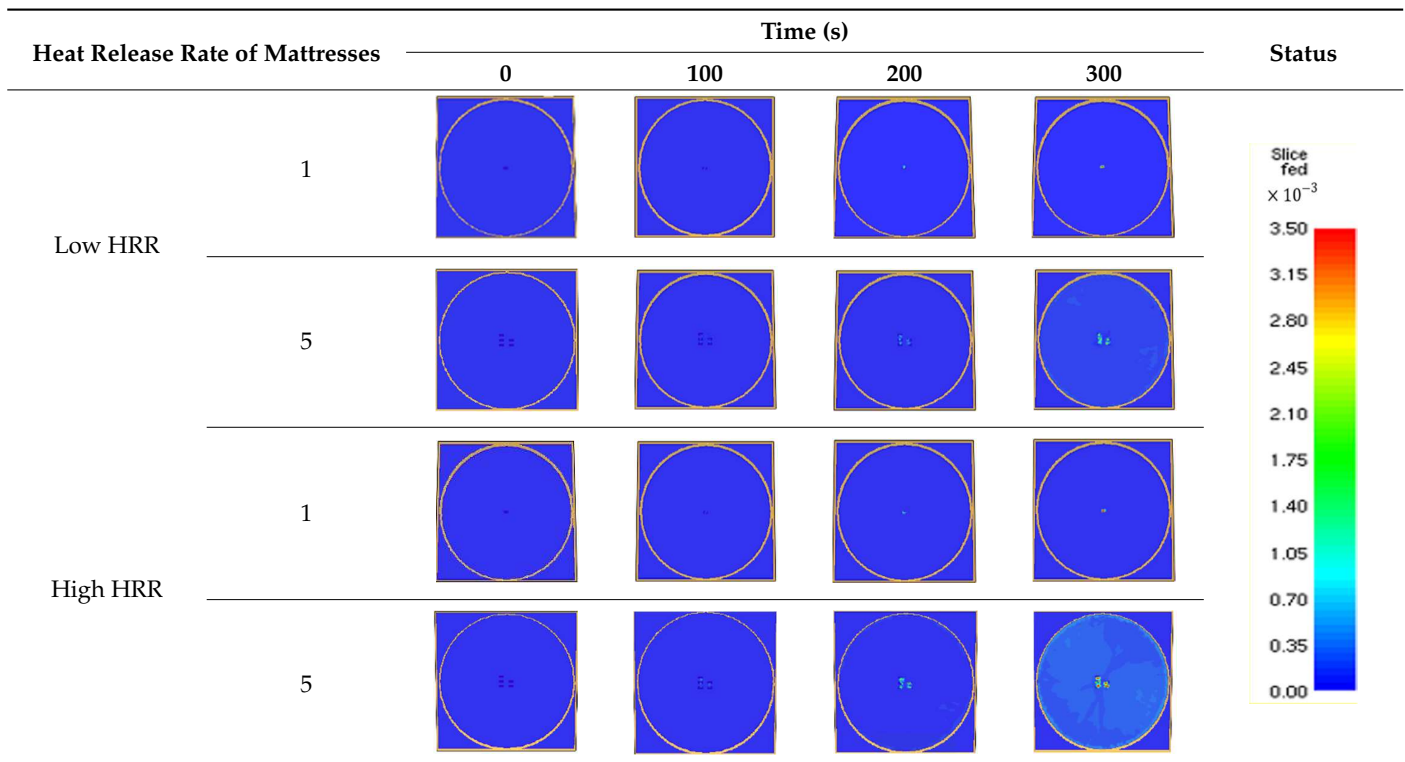

In the figure, the area marked in red indicates spatial regions that exceed the safety reference values.

Table 12 shows the visibility distribution at 1.8 m above the floor according to the one to five mattress fires at 100 s intervals for two types of low and high HRR.

Table 12. Visibility distributions by the change in fire time at the height of 1.8 m.

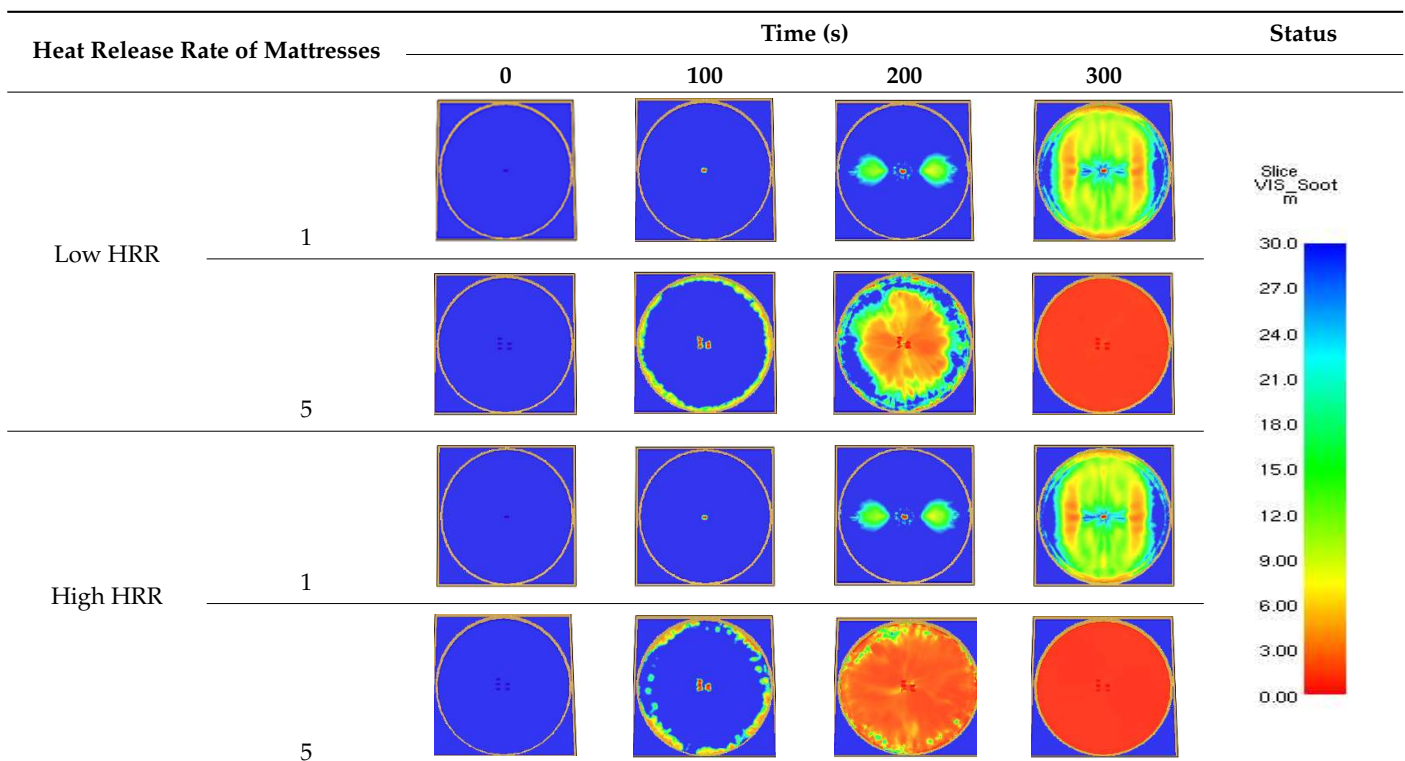

Table 13 shows the temperature distribution at 1.8 m above the floor according to the one to five mattress fires up to 300 s at 100 s intervals for the two types of low and high HRR.

Table 13. Temperature distributions by the change in fire time at the height of 1.8 m.

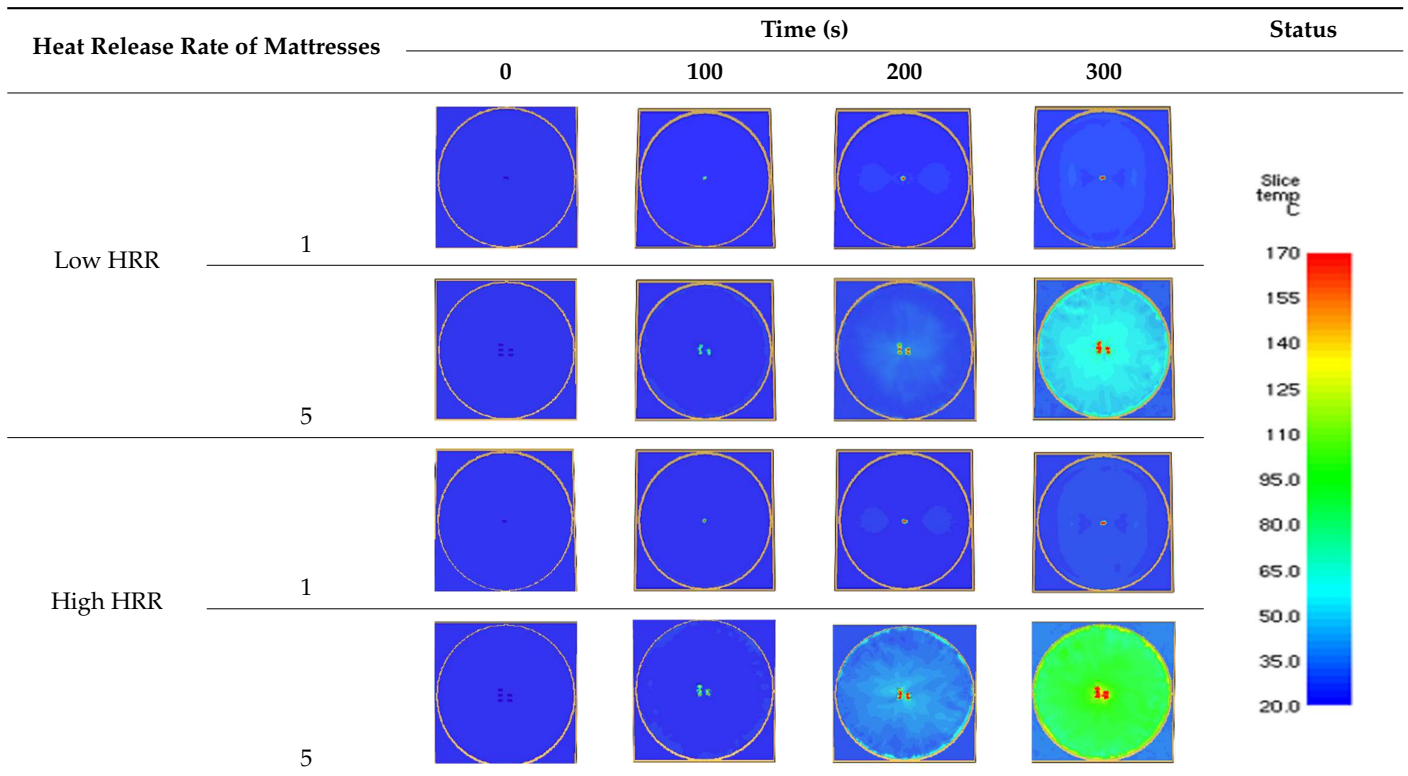

Figure 8 is a graph showing the real-time values according to the evacuation time based on the exit height of 1.8 m and in relation to the six evaluation items of the safety standards (FED, temperature, visibility, CO, O₂, and CO₂) for life shown in Table 10.

Among the six evaluation items, visibility was found to be the fastest approaches to the criteria of life safety under both the low HRR and the high HRR conditions. This is followed by the effects that temperature and FED had on evacuees. It was also confirmed that the ASET value decreased with an increasing number of fire sources (mattresses).

Figure 9 shows the ASET in combustion conditions from one mattress to a maximum of five mattresses based on visibility as a determinant of life safety criteria. This is because, among the six items in Table 10, the decrease in visibility due to smoke affects evacuation first. ASET decreased about 17% when increasing from one to two mattress fires under low HRR conditions, and it decreased by 4% when increasing from four to five mattress fires.

Under the high HRR condition, ASET showed a decrease of about 20% when increasing from one to two mattress fires and a reduction of about 5% when increasing from four to five mattress fires.

In both low and High HRR, the most significant decrease in ASET was observed when increasing from one to two mattress fires, and a minor decrease was observed when increasing from four to five mattress fires. It was also found that the higher the HRR that could be obtained, the smaller the decrease in ASET.

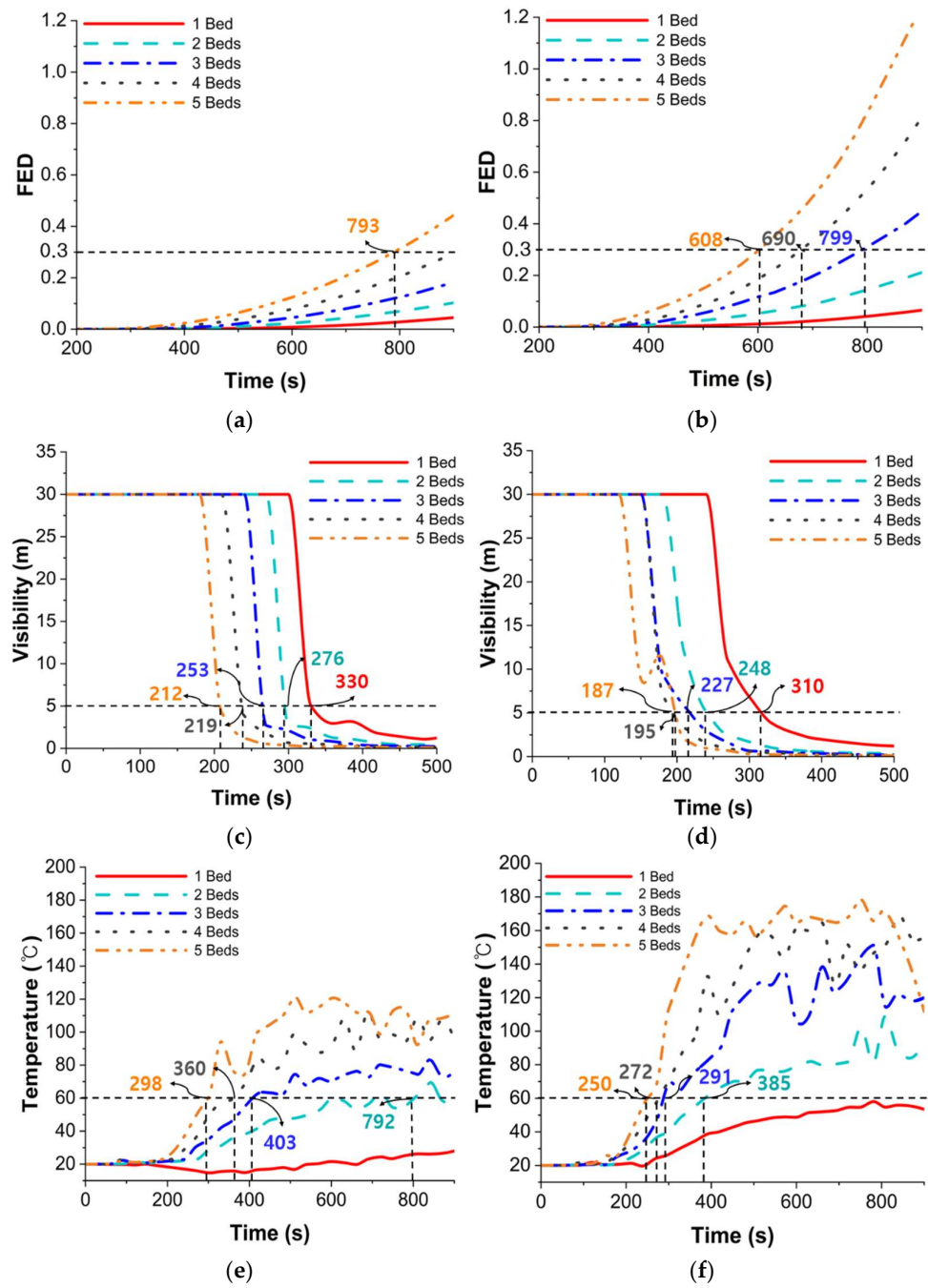

Figure 8. Cont.

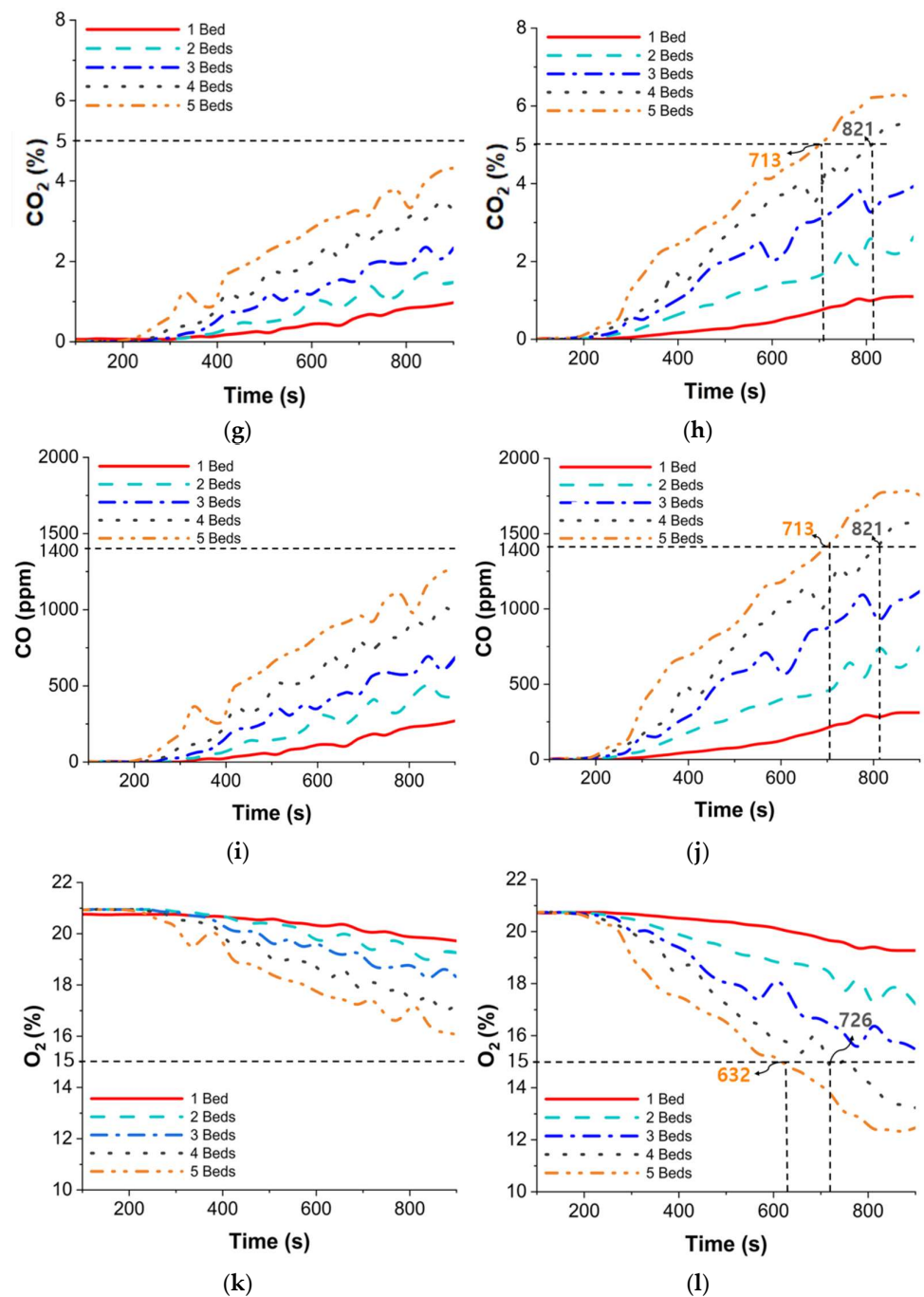

Figure 8. Real-time change value for each evaluation item compared to human safety standards according to 2 different HRRs: (a) FED (low HRR); (b) FED (high HRR); (c) visibility (low HRR); (d) visibility (high HRR); (e) temperature (low HRR); (f) temperature (high HRR); (g) CO₂ (low HRR); (h) CO₂ (high HRR); (i) CO (low HRR); (j) CO (high HRR); (k) O₂ (low HRR); (l) O₂ (high HRR).

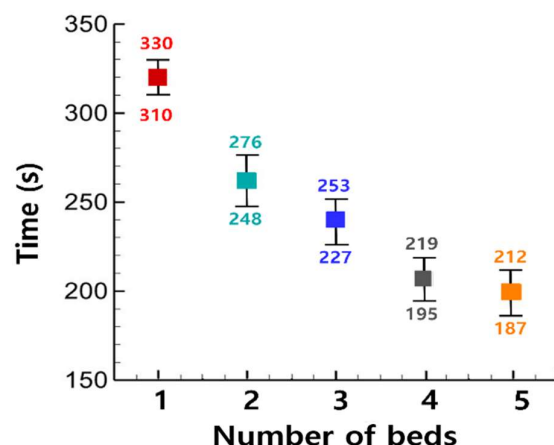

Figure 9. The ASET value according to changes in the number of mattress fires.

4. Results

Safety Evaluation for an Evacuation Route

Safety was evaluated using Equation (1), and Figure 10 shows the relative comparison of ASET and RSET by patient type according to the number of fire sources. The safety evaluation under the applied conditions proceeded as follows:

- Group without disabilities: 100% safety regardless of the evacuation route.
- Group with disabilities using canes: 100% safety in the ramp evacuation route, and in the elevator evacuation route three or less mattresses for both HRR.
- Group with disabilities using wheelchairs: 100% safety in the ramp evacuation route in a fire with three or less mattresses with lower HRR.
- Group with disabilities who are bedridden: 100% safety in the ramp evacuation route under the condition of a one-mattress fire with both HRR, and in the stair evacuation route with fewer than three mattresses for both HRR.
- Group of equal proportions of patients: 100% safety for stair and ramp evacuation routes under the condition of a one-mattress fire with lower HRR.

Tables 14–16 present the fatalities for each evacuee group according to the number of mattress fires when exclusively using either stairs, elevators, or ramps. The death prediction was based on the calculated ASET and RSET, and the number of remaining occupants was calculated at $ASET < RSET$. For all evacuation routes, as the number of mattress fires increased, the number of fatalities increased, and it can also be seen that the group without disabilities did not experience any fatalities within five mattress fires.

Table 14. A predicted number of fatalities when using only stairs (HRR: low/high).

Occupant	Number of Fire Sources				
	1	2	3	4	5
(1) Non-disabled	0/0	0/0	0/0	0/0	0/0
(2) Disabled with cane	3/9	18/28	25/33	36/45	39/48
(3) Wheelchair	0/6	18/30	29/39	43/52	46/56
(4) Bedridden	0/0	0/0	0/0	0/14	2/23
(5) Equal ratio of patients	0/0	0/5	1/17	22/39	30/45

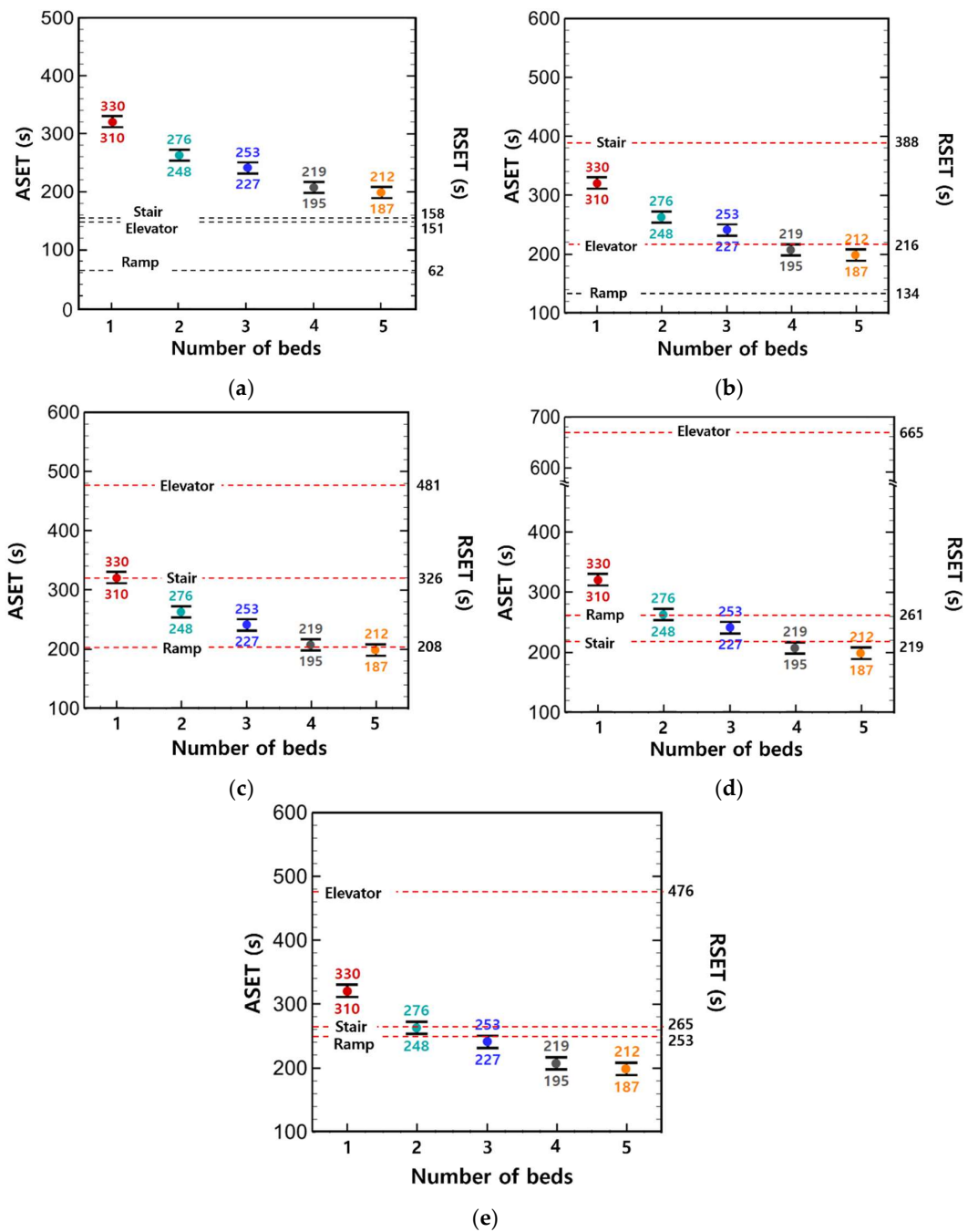

Figure 10. Comparison of ASET and RSET according to evacuation group: (a) non-disabled; (b) disabled with cane; (c) wheelchair; (d) bedridden; (e) equal ratio of patients.

Table 15. A predicted number of fatalities when using only elevators (HRR: low/high).

Occupant	Number of Fire Sources				
	1	2	3	4	5
(1) Non-disabled	0/0	0/0	0/0	0/0	0/0
(2) Disabled with cane	0/0	0/0	0/0	0/6	3/6
(3) Wheelchair	43/43	54/59	55/64	64/73	64/73
(4) Bedridden	60/63	69/74	72/78	78/84	81/84
(5) Equal ratio of patients	25/32	36/44	42/49	49/57	53/57

Table 16. A predicted number of fatalities when used only ramp (HRR: low/high).

Occupant	Number of Fire Sources				
	1	2	3	4	5
(1) Non-disabled	0/0	0/0	0/0	0/0	0/0
(2) Disabled with cane	0/0	0/0	0/0	0/0	0/0
(3) Wheelchair	0/0	0/0	0/0	0/10	0/15
(4) Bedridden	0/0	0/8	5/18	22/31	26/34
(5) Equal ratio of patients	0/0	0/5	0/16	20/32	25/34

5. Discussion

The results showed that the ramp escape route was the fastest evacuation route for all groups except for the group of patients who were bedridden. However, for the group of patients using wheelchairs, it was unsafe to have more than three mattress fires, while it was unsafe for the group of patients who were bedridden to have more than one mattress fire.

According to Tables 14–16, there was a difference in the number of fatalities according to the selection of an escape route and a moving pattern for each group of patients with disabilities. Particularly in the case of the elevator-only evacuation route, the group of patients who were bedridden was found to have the highest number of fatalities due to the occurrence of a bottleneck caused by moving with a mattress.

In the case of the stair evacuation route, it was found that the number of fatalities could be reduced by moving the patients who were bedridden on foot with the aid of two assistants while leaving the mattress behind.

For the group of patients who used canes, compared to evacuation using the stairs alone, the conversion to the ramp-only evacuation route led to a reduction in fatalities in the range from a minimum of 86.3% to a maximum of 100%.

For the group of patients who were bedridden, compared to evacuation using the elevator alone, the conversion to the ramp-only evacuation route led to a reduction in fatalities in the range from a minimum of 78.8% to a maximum of 85.2%.

6. Conclusions

In this study, a simulation-based risk analysis was performed in order to conduct ASET and RSET assessments for nursing hospital patients on a circular building floor space used to equalize the distance to the entrance of each escape route. The following conclusions may be drawn from the results of the simulation regarding the safety of evacuation-vulnerable populations:

- (1) In a circular space with an area of 2274 m², the highest-risk factor in the occurrence of at least one to five mattress fires was a decrease in visibility due to smoke. It was confirmed that the ASET had a value between 187 s for low HRR and 212 s for high HRR. This underscores the importance of smoke emission or smoke control performance evaluations based on predictions of the smoke generation of combustibles present in elderly care facilities.
- (2) The results of the fire simulation confirmed that visibility, temperature, and FED have the most significant effects on ASET, in descending order. It was also confirmed that when the size of the fire was set to 992 kW and 1778.9 kW per bed, the ASET value decreased as the number of mattress fires increased.
- (3) For the group of patients using wheelchairs, 100% safety can be ensured by evacuating through the ramp under the condition of a fire with fewer than three fire sources (mattresses) and a low HRR.
- (4) It was confirmed that 100% safety was ensured when evacuating through the ramp for the group of patients with disabilities who used canes.
- (5) Elevator evacuation was identified as the most high-risk evacuation method, as it could cause more than 40 fatalities, even in a one-mattress fire with low heat release; this is attributed to the lack of space caused by the movement of beds and wheelchairs.

- (6) In the group with equal proportions of all patients, 100% safety was secured by evacuating through stairs and ramps under the low-HRR one-mattress-fire condition.
- (7) It was confirmed that the ramp-only evacuation could reduce casualties by a minimum of one person and a maximum of 48 people compared to the stairs-only evacuation, and by a minimum of 25 people and a maximum of 60 people compared to the elevator-only evacuation. This result clarifies that the ramp is an evacuation route that can secure the safety of the vulnerable.
- (8) Therefore, it is necessary to install ramps in buildings for the vulnerable, such as elderly nursing hospitals and nursing homes, and that evacuation during disaster response training be conducted using ramps.

Based on the results of this study, to implement a specific performance-based design, it is essential to model the evaluation with an actual building and verify it through the optimal installation location for each evacuation route. In addition, if evacuation environment variables such as fire-extinguishing facilities (e.g., sprinklers and smoke exhaust facilities) are reflected, more detailed verification of lamp efficiency is possible.

Author Contributions: Conceptualization, D.R.; methodology, D.R.; formal analysis, H.K.; investigation, I.C.; resources, C.A.; writing—original draft preparation, H.K.; writing—review and editing, I.C.; supervision, D.R.; funding acquisition, C.A. All authors have read and agreed to the published version of the manuscript.

Funding: This research was supported by the Korea Agency Infrastructure Technology Advancement (KAIA) grant funded by the Ministry of Land, Infrastructure and Transport (Grant 22RMPP-C163162-02).

Institutional Review Board Statement: Not applicable.

Informed Consent Statement: Not applicable.

Data Availability Statement: The data presented in this study are available upon request from the corresponding author.

Conflicts of Interest: The authors declare no conflict of interest.

References

1. Bank, W. *World Population Ageing 2019*; United Nations: New York, NY, USA, 2019; ISBN 9789211483260.
2. Statistics Korea Homepage. Statistics for the Elderly. 2020. Available online: <http://kostat.go.kr/> (accessed on 27 March 2021).
3. BBC Homepage. Ten Die in Fire at South Korea Nursing Home. Available online: <https://www.bbc.com/news/world-asia-pacific-11740295> (accessed on 24 March 2021).
4. CNN International Homepage. Fire at South Korean Hospital for Elderly Kills 21. Available online: <https://edition.cnn.com/2014/05/27/world/asia/south-korea-deadly-fire/index.html> (accessed on 24 March 2021).
5. MBC NEWS Homepage. 'Big Disaster' after Fire at Sejong Hospital in Miryang, Icheon Freezer Fire. Available online: https://imnews.imbc.com/replay/2018/nwdesk/article/4510432_30181.html (accessed on 25 March 2021).
6. BBC Homepage. Fatal Sydney Fire: Nursing Charged with Murder. Available online: <https://www.bbc.com/news/world-asia-15800643> (accessed on 24 March 2021).
7. BBC Homepage. Quebec Fire 'Was Night from Hell'. Available online: <https://www.bbc.com/news/av/world-us-canada-25892740> (accessed on 25 March 2021).
8. BBC Homepage. China Nursing Home Fire Kills 38 in Henan. Available online: <https://www.bbc.com/news/world-asia-china-32879851> (accessed on 25 March 2021).
9. BBC Homepage. Ukraine Fire Kills 17 in Care Home Near Kiev. Available online: <https://www.bbc.com/news/world-europe-36407736> (accessed on 25 March 2021).
10. YTN Homepage. UK Senior Care Home Fire, 2 Dead. Available online: https://www.ytn.co.kr/_ln/0104_201704091013422847 (accessed on 24 March 2021).
11. MBC NEWS Homepage. Big Fire in Pennsylvania Nursing Facility. At Least 20 Injured. Available online: https://Imnews.Imbc.Com/News/2017/World/Article/4459274_31198.Html (accessed on 24 March 2021).
12. BBC Homepage. Old Vicarage Nursing Home Blaze Leaves Six in Hospital. Available online: <https://www.bbc.com/news/uk-wales-north-west-wales-42729103> (accessed on 24 March 2021).
13. Kyodo NEWS Homepage. 11 Die in Fire at Sapporo Facility for People on Welfare. Available online: <https://english.kyodonews.net/news/2018/02/80b282d021b2-update3-11-killed-in-fire-at-sapporo-facility-for-homeless-elderly-people.html> (accessed on 25 March 2021).

14. BBC Homepage. Ukraine Fire: Fifteen Dead as Blaze Guts Home for Elderly. Available online: <https://www.bbc.com/news/world-europe-55755600#:~:text=Careless%20handling%20of%20electric%20heaters%20is%20believed%20to,are%20now%20being%20treated%20at%20hospital%2C%20officials%20said> (accessed on 24 March 2021).
15. ABC NEWS Homepage. Care Home Fire Leaves Resident Dead, Firefighter Missing. Available online: <https://abcnews.go.com/US/wireStory/fire-forces-evacuations-york-assisted-living-facility-76625402> (accessed on 25 March 2021).
16. Lee, D.; Heo, I.; Khaliunaa, D.; Han, S.J.; Kim, K.S. Performance-Based Evaluation on Egress Safety of Nursing Hospitals Considering Egress Guides and Delay Time. *J. Korean Soc. Hazard Mitig.* **2020**, *20*, 149–157. [CrossRef]
17. Kim, J.B.; Kim, J.O.; Back, E.S. A Study on the Evaluation of Evacuation Safety Function of an Elderly Care Hospital. *Fire Sci. Eng.* **2010**, *24*, 9–19.
18. Jeon, I.B.; Lee, I.M.; Hwang, Y.W.; Chon, Y.W. Calculation of Evacuation Time from Elderly Medical Welfare Facilities Using FDS and Pathfinder. *Korean J. Hazard. Mater.* **2018**, *6*, 120–134. [CrossRef]
19. Hong, S.; Jang, J.S.; Park, H.A.; Rie, D.H. A Study on Evacuees Risk Assessment for Application of Spatial Risk Information. *Fire Sci. Eng.* **2015**, *29*, 8–12. [CrossRef]
20. Xiao, M.; Zhou, X.; Han, Y.; Bai, G.; Wang, J.; Li, X.; Sunya, S. Simulation and optimization of fire safety emergency evacuation in university library. *AIP Adv.* **2021**, *11*, 065323. [CrossRef]
21. Boonngam, H.; Patvichaichod, S. Fire evacuation and patient assistance simulation in a large hospital building. *IOP Conf. Ser. Mater. Sci. Eng.* **2020**, *715*, 012004. [CrossRef]
22. Hunt, A.; Gwynne, S.; Lawrence, E.; Frost, I. Simulating Movement Devices Used in Hospital Evacuation. *Fire Technol.* **2020**, *56*, 2209–2240. [CrossRef]
23. Anastasios, K.; Despina, P.; Nikolas, G.; Dimitrios, K. Evacuation in an Underground Space: A Real-Time Investigation of Occupants' Travel Speed in Clear and Smoked Environments. *Infrastructures* **2022**, *7*, 57. [CrossRef]
24. Khorram-Manesh, A.; Phattharapornjaroen, P.; Mortelmans, L.; Goniewicz, K.; Verheul, M.; Sørensen, J.L.; Pereira, I.; Ricklin, M.E.; Faccincani, R.; Dark, P.M.; et al. Current Perspectives and Concerns Facing Hospital Evacuation: The Results of a Pilot Study and Literature Review. *Disaster Med. Public Health Prep.* **2021**, 1–9. [CrossRef]
25. Elderly Welfare Act Enforcement Rule: Changes to the Law; Republic of Korea. 2021. Available online: <https://www.law.go.kr/LSW/eng/engLsSc.do?menuId=2§ion=lawNm&query=OLDER+PERSONS&x=0&y=0#liBgcolor7> (accessed on 22 February 2021).
26. Fire Dynamics Simulator User's Guide. NIST (2013). Available online: <https://pages.nist.gov/fds-smv/manuals.html> (accessed on 29 April 2022).
27. Thunderhead Engineering Pathfinder User Manual. Available online: <https://support.thunderheadeng.com/docs/pathfinder/2022-1/user-manual/> (accessed on 16 June 2021).
28. Trimble Inc. SketchUp Free. 2022. Available online: <https://www.sketchup.com/ko/plans-and-pricing/sketchup-free> (accessed on 13 May 2022).
29. Korean Human Body Index Survey Homepage. Available online: <http://sizekorea.kr/measurement-data/body> (accessed on 1 May 2021).
30. KS P 6113; Wheelchair Standard. National Standard Certification Integrated Information System: Seoul, Korea, 2007.
31. No. 2017-16; Standard for Mattress. Ministry of Food and Drug Safety: Seoul, Korea, 2017.
32. Kim, E.S.; Lee, J.S.; Kim, M.H.; You, H.K.; Song, Y.H.; Min, K.C. A Study on Evacuation of Patients in Hospital: Part I. *Fire Sci. Eng.* **2005**, *19*, 20–28.
33. Kuligowski, E.; Peacock, R.; Wiess, E.; Hoskins, B. Stair evacuation of older adults and people with mobility impairments. *Fire Saf. J.* **2013**, *62*, 230–237. [CrossRef]
34. Choi, J.H.; Jeon, E.M.; Hong, W.H.; Ryou, H.S. Calculation of Revision Coefficient of Evacuee's Walking Speed to Operate an Evacuation Simulator aiming at a High-rise Building. *J. Archit. Inst. Korea* **2009**, *29*, 649–652.
35. Seo, B.Y.; Jang, W.B.; Park, K.W.; Hong, W.H. Experimental Study on the Measurement of Fire Behavior and Heat Release Rate in Building Compartment Space—Focus on Full Scale Fire Test of the Bed Mattress. *Fire Sci. Eng.* **2018**, *32*, 28–33. [CrossRef]
36. Kim, D.E.; Hong, H.R.; Seo, D.G.; Kwon, Y.J. A Study on the Fire Behavior of Combustibles for Prediction of Fire in an Apartment House. *J. Archit. Inst. Korea Plan. Des.* **2012**, *28*, 73–80.
37. Notification No. 2016-30; Methods and Standards of the Performance-Oriented Design for Fire Facilities. Ministry of Public Safety and Security (MPSS), Fire Prevention Division: Seoul, Korea, 2016.