


Article

# Pollutants Emitted from 3D Printers onto Operators

Anna Karwasz \* , Filip Osiński \* and Krzysztof Łukaszewski \*

Faculty of Mechanical Engineering, Poznan University of Technology, Piotrowo 3 STR, 60-138 Poznań, Poland

\* Correspondence: anna.karwasz@put.poznan.pl (A.K.); filip.osinski@put.poznan.pl (F.O.);

krzysztof.g.lukaszewski@doctorate.put.poznan.pl (K.Ł.)

**Abstract:** Volatile organic compounds are released during 3D printing, which can irritate the throat mucosa, cause cardiovascular disease and even, in extreme cases, cause a stroke. The survey research was carried out regionally, in the Greater Poland area, with students and lecturers of Poznań University of Technology. The survey was conducted in October and November 2021 among 31 students and 4 lecturers. Students in their third year of engineering studies in Mechanics and Machine Design, Mechatronics, and Biomedical Engineering who are interested in 3D printing have contact with additive manufacturing, personally print on their printers at home or at someone else's, or submit their projects for printing outside. The survey showed how long, how often and from what materials the items are most often printed. The survey also showed that over 60% of respondents keep the printer in a room where they spend most of the day or sleep. A simulation was made of how contaminants were extracted from the printer when opening the door during or just after additive manufacturing. The tests were carried out in the ANSYS Fluent 2021 simulation environment. Three experiments were carried out, which show how the contamination, depending on the density, circulates around the printer operator and how quickly it spreads around. It has been identified that the operator, in less than 3 s after opening the door, is exposed to the pollution previously accumulated inside the chamber. The pollutants emanating from the chamber take the form of a cloud surrounding the operator's head.

**Keywords:** additive manufacturing; air pollution; VOC; nanoparticles



**Citation:** Karwasz, A.; Osiński, F.; Łukaszewski, K. Pollutants Emitted from 3D Printers onto Operators. *Sustainability* **2022**, *14*, 1400. <https://doi.org/10.3390/su14031400>

Academic Editor: Paolo Monti

Received: 21 December 2021

Accepted: 21 January 2022

Published: 26 January 2022

**Publisher's Note:** MDPI stays neutral with regard to jurisdictional claims in published maps and institutional affiliations.



**Copyright:** © 2022 by the authors. Licensee MDPI, Basel, Switzerland. This article is an open access article distributed under the terms and conditions of the Creative Commons Attribution (CC BY) license (<https://creativecommons.org/licenses/by/4.0/>).

## 1. Introduction

Nowadays, people spend a significant part of their time indoors, where restriction of airflow can lead to the accumulation of harmful compounds. Working in rooms where various types of volatile compounds or dusts are emitted may pose a significant threat to the health of employees, operators or bystanders. Pollution also comes from the external environment and accumulates in the room. Correct determination of the risk to the health of individual people requires the determination of both of these components on the Air Pollution Index. The article describes the risks that may result from Fused Deposition Modelling in closed rooms, where the work is carried out by a single operator.

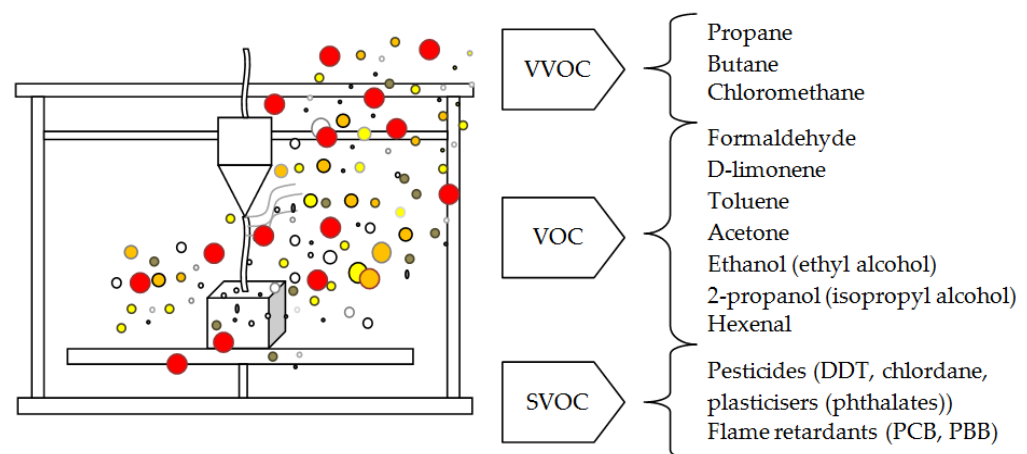
Three-dimensional printing, 3D printers and FDM/FFF technologies are becoming increasingly popular. The rapid development of FFF technology has led to the manufacture of increasingly reliable and modern printers as well as a fall in their prices, which has increased their availability. There are many manufacturers of these devices on the market. Their prices are sufficiently competitive for people to be able to afford to buy them for home use—especially as it is not hard to operate them. Many of these printers, both with open and closed print chambers, are used in schools for educational purposes and in offices for training purposes [1–3]. People also use them at home for their own small-scale needs. At the moment, there are no legal requirements for the selection of specific devices to the conditions of their work or their destination (e.g., schools). The selection in the vast majority of cases is dictated by the anticipated methods of use and the budget that the

buyer has at his disposal. Due to the significantly lower purchase costs of an open-chamber device, most of the devices available on the market are open-chamber designs.

Three-dimensional printers are used to print objects with complex shapes that can be made easily, cheaply and very quickly using additive technology, which is not the case in subtractive manufacturing. Additive manufacturing is used in many fields, including medicine, nanomedicine, radiology, surgery, diagnostics, prosthetics, and orthopaedics; that is, wherever individual adjustment of a single item and manufacturing time are very important [2–8]. Three-dimensional printers are used to print ankle orthoses, foot orthoses, wrist orthoses, prosthetic sockets (prosthetic alveoli) or mandibles. Preoperative support and preparation of the surgeon with additive manufacturing technology, especially in complex cases, can be helpful in preparing a more accurate surgery plan and performing surgery simulation [9,10]. Future surgeons or orthopaedic surgeons can train on printed organs. They can simulate a difficult surgery on, for example, a printed mandible or kidney [2].

Three-dimensional printing features various kinds of filaments, including ABS, ASA, PLA, PET, HIPS or PS, in many different colour combinations. During 3D printing, the nozzle through which the material passes is heated to 180–270 °C. In some cases, the worktable is also heated within a temperature range of 40–110 °C. When the nozzle and plastic are heated, gases and solid particles which have a negative impact on the natural environment are released; see Figure 1. Volatile organic compounds are emitted and these affect the human body as well [11–13]. A VOC is any organic compound that has an initial boiling point less than or equal to 250 °C measured at a standard atmospheric pressure of 101.3 kPa. This classification means that most of the compounds classified as VOCs and VVOCs will evaporate during the passage of the working material through the hot end, where the temperature, depending on the filament used, is in the range of 180–270 C degrees. VOCs are sometimes categorised by the ease with which they will be emitted. For example, the World Health Organisation (WHO) categorises indoor organic pollutants as:

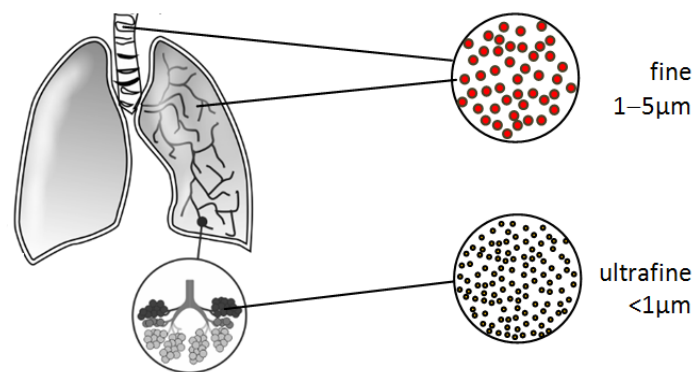
- Very volatile organic compounds (VVOCs).
- Volatile organic compounds (VOCs).
- Semi-volatile organic compounds (SVOCs).



**Figure 1.** Compounds emitted during additive manufacturing [11,13].

The higher the volatility (lower the boiling point), the more likely the compound will be emitted from a product or surface into the air. Very volatile organic compounds are so volatile that they are difficult to measure and are found almost entirely as gases in the air rather than in materials or on surfaces. The least volatile compounds found in air constitute a far smaller fraction of the total present indoors, while the majority will be in solids or liquids. Figure 1 presents examples of the most frequently identified substances during additive manufacturing.

Research carried out so far indicates that 3D printers are sources of many volatile organic compounds and particles which are released into the air in rooms where additive manufacturing takes place [14–17]. These are solid and volatile particles which are inhaled and thus enter the human body; see Figure 2. These ultrafine particles can even penetrate through the skin into the bloodstream. It should also be noted that the accumulation of many printing machines in one room further exacerbates the pollution that has a negative impact on human health.



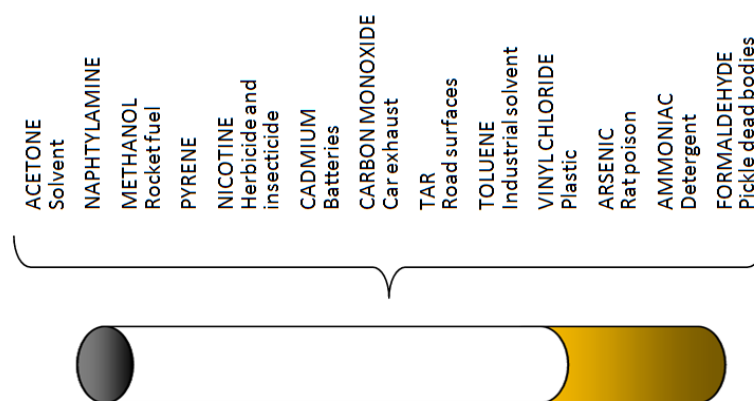
**Figure 2.** Parts of the human respiratory system particularly exposed to the effects of solid particles [14,15].

Volatile organic compounds are a group of substances from various classes of chemicals that evaporate more or less rapidly at room temperature. The WHO has divided these organic pollutants into three categories according to their boiling point: very volatile, volatile or semi-volatile organic compounds (mainly present as gases in the air) [17]. Short exposure to VOCs may cause eye and respiratory irritation, headaches, dizziness as well as blurred vision. Prolonged exposure can cause more serious symptoms such as tiredness, loss of coordination, and damage to the liver, kidneys and the central nervous system. The VOCs include formaldehyde, d-limonene, toluene, acetone, ethanol, 2-propanol and hexenal. Ultrafine particles do not always have to be harmful substances. The damage caused by these particles stems more from their small size and ability to penetrate into the lungs, which may have long-term cardiovascular consequences. Some of the particles are shaped like hooks or long wires, or they combine to form these shapes, which makes it impossible to cough them up [18]. Ultrafine particles, due to their small size, are not retained in the bronchi, which would make it possible to get rid of them as a result of coughing. Such tiny particles pass through the entire human respiratory system to the alveoli, where they can either accumulate into larger particles or directly enter the bloodstream.

The components of indoor air pollution can be divided into several categories according to their physical properties, chemical properties, adverse health effects or source of pollution. For example, the classification of chemical properties often distinguishes chemical pollutants such as volatile organic compounds (VOCs), nitrogen oxides (NO<sub>x</sub>), carbon monoxide (CO), polycyclic aromatic hydrocarbons, phthalates; organic pollutants such as mould, house dust mite allergens, pollen, and physical pollutants including particles and fibres (asbestos, artificial mineral fibres etc.). When it comes to adverse effects on human health, VOCs and aldehydes are the most common causes of eye and respiratory irritation. Some of them—for example, benzene and formaldehyde—are still classified as “carcinogenic to humans” by the International Agency for Research on Cancer [19].

Solid and volatile particles released during additive manufacturing can be compared to those released during cigarette smoking [20]. A very extensive study on cigarette smoking and passive smoking has been included in a report produced by medical experts from around the world [20]. A complex and multilayered immune defence system protects the host against harmful agents and maintains tissue homeostasis. Cigarette smoke exposure markedly impacts the immune system, compromising the host’s ability to mount appropriate immune and inflammatory responses and contributing to smoking-related pathologies.

These adverse effects on the immune system not only occur in active smokers, but also in those exposed to smoke passively in contaminated environments, and may persist for decades after exposure has ended. Figure 3 shows examples of substances that can be found in cigarette smoke, at the moment; the list of all substances that have been identified consists of 127 positions [21]. Research on the effects of cigarette smoke on human health is one of the most developed in the field of science. An unambiguous comparison of the health risk of cigarettes and the emissions from the additive manufacturing process is not possible at the moment and may constitute a research gap. Despite the presence of similar compounds in both forms of pollution, it should be noted that exposure to cigarette smoke is usually short and intense, while in the case of being in the 3D printing room, the exposure is relatively low intensity, but long-lasting.



**Figure 3.** Cigarette contents. Some of the chemical contents found in a cigarette [22].

National requirements concerning the concentrations of the most frequently emitted substances in additive manufacturing differ between the countries. Table 1 presents examples of maximum workplace concentration limits for various regions: Poland (NDS—exposure limit), European Union (OSHA Guidelines) and the United States (NOISH) [23–26]. In addition, the table includes information that makes it possible to convert various units as well as odour thresholds. An important determinant of how harmful a substance is to persons exposed to it is the TWA—time-weighted average, which determines the average concentration for an 8 h exposure time in situations when the concentration changes over time. Another factor indicating the magnitude of exposure is ST (short-term exposure), which defines the maximum instantaneous concentration level of the substances in question, assuming a maximum exposure of 5 min during any 3 h of work [27,28].

**Table 1.** Exposure limits for toxic substances emitted during additive manufacturing in various countries NDS—Poland; OSHA—European Union; NOISH—USA [23–26].

ABS Emission	CAS Number	NDS (Poland)	NDSch (Poland)	OSHA TWA	OSHA C	NOISH TWA (USA)	NOISH ST (USA)	Odour Threshold	Conversion
		mg/m <sup>3</sup>	mg/m <sup>3</sup>	ppm	ppm	ppm	ppm	ppm	mg/m <sup>3</sup> /ppm
Styrene	100-42-5	50	100	100	100	50	100	0.016	4.26
Ethylbenzene	100-41-4	200	400	100	-	100	125	0.27	4.34
Benzaldehyde	100-52-7	10	20	No limits	No limits	No limits	No limits	0.042	5.18
Trichloroethene	79-00-5	40	-	10	-	10	-	0.5	5.46
Acetaldehyde	75-07-0	-	45	200	-	200	-	0.067	1.18
Formaldehyde	50-00-0	0.37	0.74	0.16	0.1	0.75	2	0.5	1.23
1-butanol	71-36-3	50	150	100	-	50	-	0.83	3.03
p.m-Xylene	1330-20-7 (isomer mix)	100	200	100	-	100	150	1	4.35
Ethanol	64-17-5	1900	-	1000	-	1000	-	84	1.89
Acetone	67-64-1	600	1800	1000	-	250	-	42	2.38
Propylene glycol	107-21-1	15	50	No limits	No limits	No limits	No limits	39	2.49
Hexenal	66-25-1	40	80	500 (PEL)	-	No limits	No limits	5.2	-



Significantly, most identified substances have exposure limits much higher than the odour threshold. The situation can cause a high degree of odour nuisance during additive manufacturing, even though the safety thresholds legally in force in a given country have not been reached. In addition, the thresholds can vary considerably, depending on the country/area in which manufacturing takes place. For some of the substances identified in the various areas, the differences are several- or even more than tenfold.

Significantly, the exposure limits specified in national regulations do not always remain safe for the health of those exposed to them. In particular, in the case of prolonged exposure in a given environment some of the substances listed above are toxic even in concentrations much lower than the limits.

Table 2 presents the most common health effects of contact with substances emitted as a result of additive manufacturing. The most frequently observed problems include nausea, vomiting, eye or skin irritation as well as general respiratory problems.

**Table 2.** Health effects and threshold limit values for some substances emitted during additive manufacturing [29–32].

Emitted Substance	CAS Number	Route of Exposure	Symptoms and Effects	Toxicity
Styrene	100-42-5	Eye, skin contact, ingestion, inhalation	<ul style="list-style-type: none"> <li>• Potentially carcinogenic</li> <li>• Irritation to the respiratory system</li> <li>• Central nervous system depressant</li> <li>• Pulmonary oedema</li> <li>• Functional disorders of the nervous system and liver</li> <li>• Mutagenic</li> <li>• Teratogenic effects</li> </ul>	LD50 oral rat: 2650 mg/kg LC50 inhalation, rat: 12 mg/m <sup>3</sup> /4 h
Ethylbenzene	100-41-4	Inhalation, eye contact	<ul style="list-style-type: none"> <li>• Irritant effects</li> <li>• Vertigo</li> <li>• Headache</li> <li>• Dizziness</li> <li>• Nausea</li> <li>• Vomiting</li> <li>• Spasms</li> <li>• Aspiration hazard</li> </ul>	LD50 oral, rat: 3500 mg/kg LD50 dermal, rabbit 15.4 mg/kg LC50 inhalation, rat: 17.2 mg/L/4 h
Benzaldehyde	100-52-7	Eye, skin contact, inhalation, ingestion	<ul style="list-style-type: none"> <li>• Skin irritation</li> <li>• Breathing difficulties</li> <li>• Allergic skin reaction</li> <li>• Asthma</li> <li>• Nausea</li> <li>• Vomiting</li> </ul>	LD50 oral, rat: 1300 mg/kg LD50 dermal, rabbit: 1250 mg/kg
Trichloroethene	79-00-5	Eye, skin contact, inhalation, ingestion	<ul style="list-style-type: none"> <li>• Skin irritation</li> <li>• Carcinogenic</li> <li>• Mutagenic substance</li> <li>• Functional disorders of the nervous system</li> <li>• Dizziness</li> <li>• Nausea</li> <li>• Vomiting</li> </ul>	LC50 inhalation, rat: 140,700 mg/m <sup>3</sup> LD50 oral, rat: 4920 mg/kg

Table 2. Cont.

Emitted Substance	CAS Number	Route of Exposure	Symptoms and Effects	Toxicity
Acetaldehyde	75-07-0	Eye, skin contact, inhalation, ingestion	<ul style="list-style-type: none"> <li>• Blurred vision</li> <li>• Nausea</li> <li>• Dizziness</li> <li>• Vomiting</li> <li>• Pulmonary edema</li> <li>• Convulsions</li> <li>• Shortness of breath</li> </ul>	LD50 dermal, rat: 3540 mg/kg LC50 inhalation, rabbit 13,300 ppm/kg
mFormaldehyde	50-00-0	Eye, skin contact, inhalation, ingestion	<ul style="list-style-type: none"> <li>• Breathing difficulties</li> <li>• Allergic skin reaction</li> <li>• Headache</li> <li>• Dizziness</li> <li>• Tiredness</li> <li>• Nausea</li> <li>• Vomiting</li> </ul>	LD50 oral, rat: 500 mg/kg LC50 inhalation, rat: 0.578 mg/L
1-butanol	71-36-3	Eye, skin contact, inhalation, ingestion	<ul style="list-style-type: none"> <li>• Skin irritation</li> <li>• Eye damage</li> <li>• Respiratory irritation</li> </ul>	LD50 oral, rat: 700 mg/kg LC50 inhalation, rat: 8000 ppm
p,m-Xylene	1330-20-7 (isomer mix)	Eye, skin contact, inhalation, ingestion	<ul style="list-style-type: none"> <li>• Breathing difficulties</li> <li>• Headache</li> <li>• Dizziness</li> <li>• Tiredness</li> <li>• Nausea</li> <li>• Vomiting</li> </ul>	LD50 oral, rat: 3608 mg/kg LC50 inhalation, rat: 4330 ppm
Ethanol	64-17-5	Ingestion, inhalation	<ul style="list-style-type: none"> <li>• Irritation</li> <li>• Nausea</li> <li>• Vomiting</li> <li>• Abdominal pain</li> <li>• Breathing difficulties</li> <li>• Vertigo</li> <li>• Drowsiness</li> <li>• Narcosis</li> </ul>	LD50 oral, rat: 7.060 mg/kg LC50 inhalation, rat: 95.6 mg/L/4 h
Acetone	67-64-1	Eye, skin contact, inhalation, ingestion	<ul style="list-style-type: none"> <li>• Eye irritation</li> <li>• Dizziness</li> <li>• Drowsiness</li> </ul>	LD50 oral, rat: 9570 mg/kg
Propylene glycol	107-21-1	Eye, skin contact	<ul style="list-style-type: none"> <li>• Skin irritation</li> <li>• Eye irritation</li> </ul>	LD50 oral, rat: 30,000 mg/kg LD50 dermal, rat: 10,000 mg/kg
Hexenal	66-25-1	Eye, skin contact, inhalation, ingestion	<ul style="list-style-type: none"> <li>• Headache</li> <li>• Dizziness</li> <li>• Tiredness</li> <li>• Nausea</li> <li>• Vomiting</li> </ul>	LD50 oral, rat: 4890 mg/kg

Among the pollutants emitted as a result of the process, there are also health consequences which may be much more significant for users exposed to these substances over a long period.

Styrene, a substance identified in all emission tests, is a potential carcinogen in additive manufacturing featuring ABS [29]. Numerous studies have demonstrated significant

mutagenicity and teratogenicity from inhalation exposure to styrene and reduced life expectancy for employees exposed to this substance continuously [30–32].

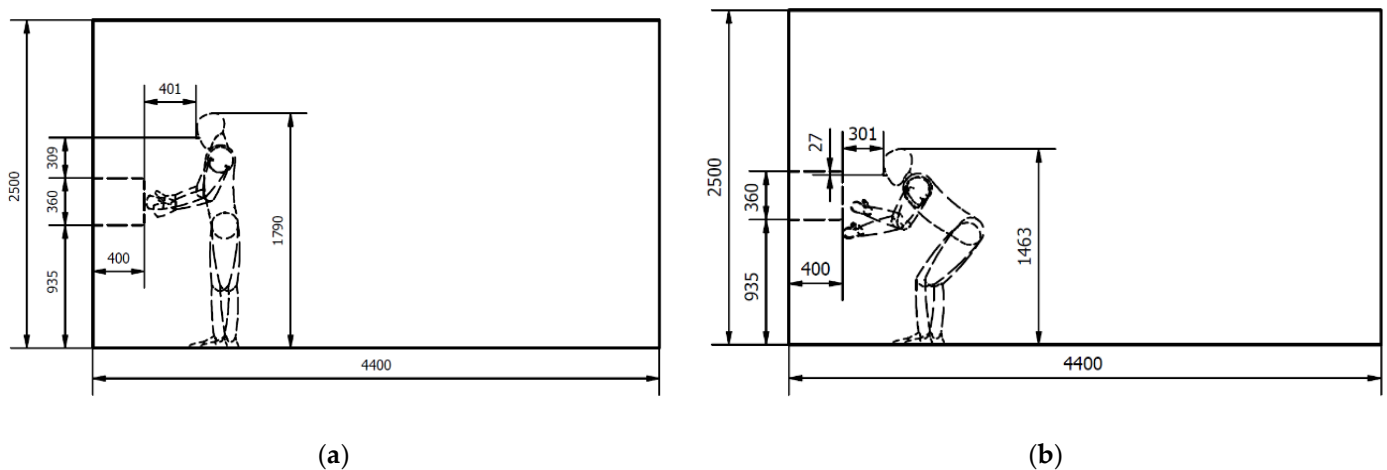
Exposure can occur during hours of additive manufacturing, when pollutants accumulate in a closed, unventilated room. In addition, in rooms with more than one printer exposure can often be intensified [33].

In view of the above, the authors of the present study believe that the exposure of 3D printer operators is high and that the way pollutants are released from the printer should be thoroughly investigated and determined.

The objective of the study was to simulate how pollutants are emitted from the printer when the printer door is opened during additive manufacturing or immediately after the end of such manufacturing. The simulations and tests were carried out for a printer with a closed design, due to the better possibility of observing the flow of a cloud of pollutants during the operator's work near the printer's working field. Working with a device of such a structure, despite the apparent protection against continuous emission into the room, causes the accumulation of pollutants that may rapidly escape from the printer after opening the chamber door.

## 2. Research Methodology

The modelling was conducted in the ANSYS Fluent 2021 simulation environment [34]. The printer operator, standing in front of the printer or leaning towards it, pulls the finished model out of the printer, opens the printer door during the process, adjusting the filament, and reacts to process disturbances. During that time, pollutants generated during printing are emitted onto the operator. Therefore, the model was prepared for two operator positions: (a)—standing in front of the printer and (b)—leaning in front of the printer, Figure 4a,b. The printing takes place in a closed room with a printer with a closed print chamber. The dimensions of the simulation room were assumed as follows: length 4.4 m, height 2.5 m, width 2.6 m ( $V = 28.6 \text{ m}^3$ ). A printer with the following dimensions was placed in the room: width 0.526 m, length 0.400 m, height 0.360 m ( $V = 0.075 \text{ m}^3$ ). The door at the front of the printer, through which pollutants are emitted, measured 0.37 m (width) by 0.22 m (height) ( $0.080 \text{ m}^2$ ).



**Figure 4.** Simulation object model, (a) printer operator standing in front of the printer; (b) operator leaning in front of the printer.

Finite element mesh parameters:

- (a) For the operator standing in front of the printer:
- Element order: Linear → first-order elements—these are elements which only have a node at the vertex; they are sufficient for the purpose of this study, because a large model with many nodes is assumed.
  - Type of elements used: Tet4 (4 Nodes tetrahedral).
  - Global element size: 100 mm.
  - Number of nodes = 222,314.
  - Number of finite elements = 1,202,884.
  - Thanks to the introduction of a parameter controlling the desired skewness = 0.5, a mesh of high overall quality with a small number of deformed elements was obtained.
- (b) For the operator leaning in front of the printer:
- Element order: Linear → first-order elements—these are elements which only have a node at the vertex; they are sufficient for the purpose of this study, because a large model with many nodes is assumed.
  - Type of elements used: Tet4 (4 Nodes tetrahedral).
  - Global element size: 100 mm.
  - Number of nodes = 20,6957.
  - Number of finite elements = 1,118,843.
  - Thanks to the introduction of a parameter controlling the desired skewness = 0.5, a mesh of high overall quality with a small number of deformed elements was obtained.

Calculation parameters entered in the CFD Fluent module (Computational fluid dynamics):

Solver used: pressure-based solver making it possible to calculate incompressible flows, used when flow velocity is low. Temporal transient, 3D spatial and viscosity calculations were carried out by means of the Standard k-epsilon turbulence model, multiphase volume of fluid; the calculations took into account gravitational acceleration of  $9.81 \text{ m/s}^2$  and operating pressure (in the room) of 101,325 Pa. The model included gravitational airflow out of the room through an outlet vent located on the wall behind the operator.

Parameters of the dominant—main fraction, air, Table 3.

**Table 3.** Basic ambient parameters.

Property	Units	Value (s)
Density	kg/m <sup>3</sup>	1.225
Viscosity	kg/ms	$1.7894 \times 10^{-5}$
Molecular weight	kg/kmol	28.966

The calculations were carried out for three types of pollutants—gases, emitted from an area of  $0.080 \text{ m}^2$  with a theoretical velocity of 1 m/s: for a fraction with density the same as ambient density, for a fraction with density lower than ambient density and for a fraction with density heavier than ambient density. The results are presented in Tables 4–6.

**Table 4.** Fractions with density the same as ambient density.

Property	Units	Value (s)
Density	kg/m <sup>3</sup>	1.225
Viscosity	kg/ms	$1.7894 \times 10^{-5}$
Molecular weight	kg/kmol	28.966

**Table 5.** Fractions with density lighter than air.

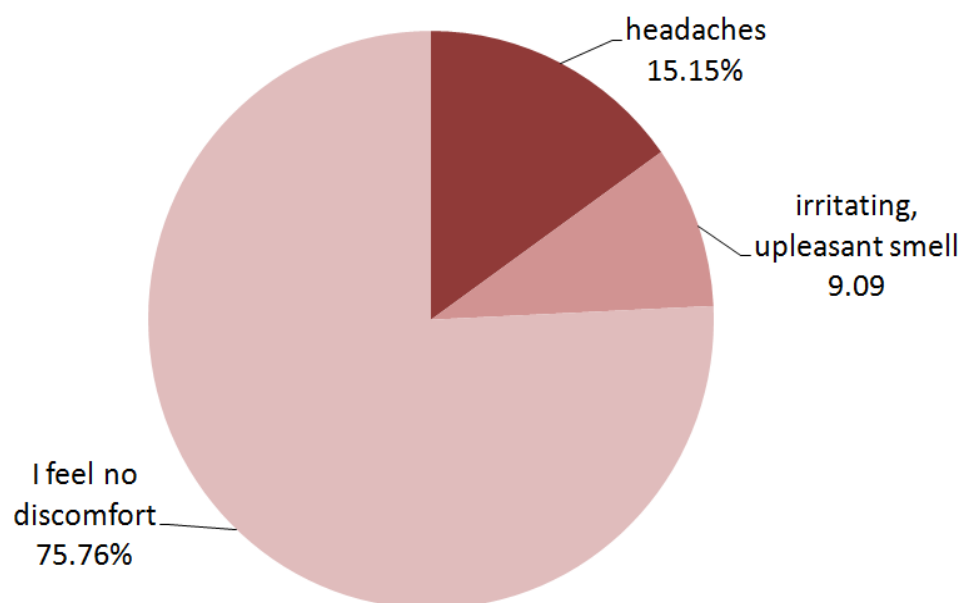
Property	Units	Value (s)
Density	kg/m <sup>3</sup>	0.6679
Viscosity	kg/ms	$1.087 \times 10^{-5}$
Molecular weight	kg/kmol	16.04303

**Table 6.** Fractions with density heavier than air.

Property	Units	Value (s)
Density	kg/m <sup>3</sup>	1.7878
Viscosity	kg/ms	$1.37 \times 10^{-5}$
Molecular weight	kg/kmol	44.00995

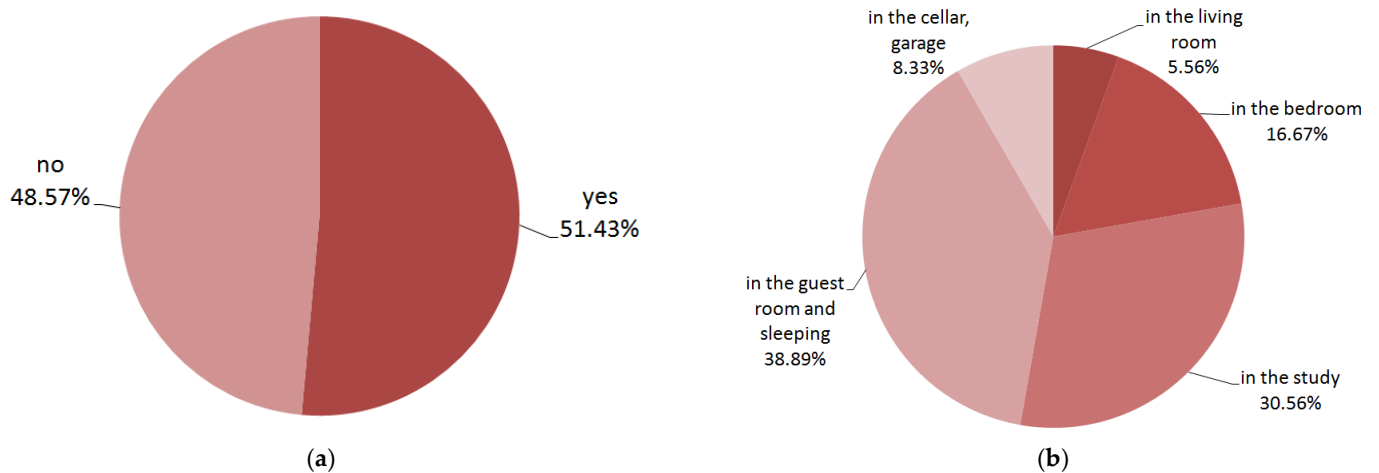
### 3. Results and Discussion

Between October and November 2021, the authors of the study carried out a survey of Poznań University of Technology students and staff, asking about home, company and school use of 3D printers. A total of 35 people participated in the study, mainly students and employees of the Poznań University of Technology. The people taking part in the study are people who use additive manufacturing in their daily work as well as in their free time. The demographics of responders were as follows: aged 21–30 years (88.6%); 31–40 years (11.4%); gender of responders: men 94%; women 6%; place of printing: big city 58%; small towns or villages 42%. In total, 24% of the respondents admitted that they experienced headaches or irritating odours during 3D printing; see Figure 5.

**Figure 5.** Answer to the question: Do you experience headaches, irritating odours, or feel no discomfort after being in a 3D printing room for a long while (2 h or more)?

Among all the respondents, over a half use a 3D printer at home; see Figure 6a. No fewer than 61% of them use a 3D printer in a room in which they spend a majority of their day, entertain guests or sleep; see Figure 6b.

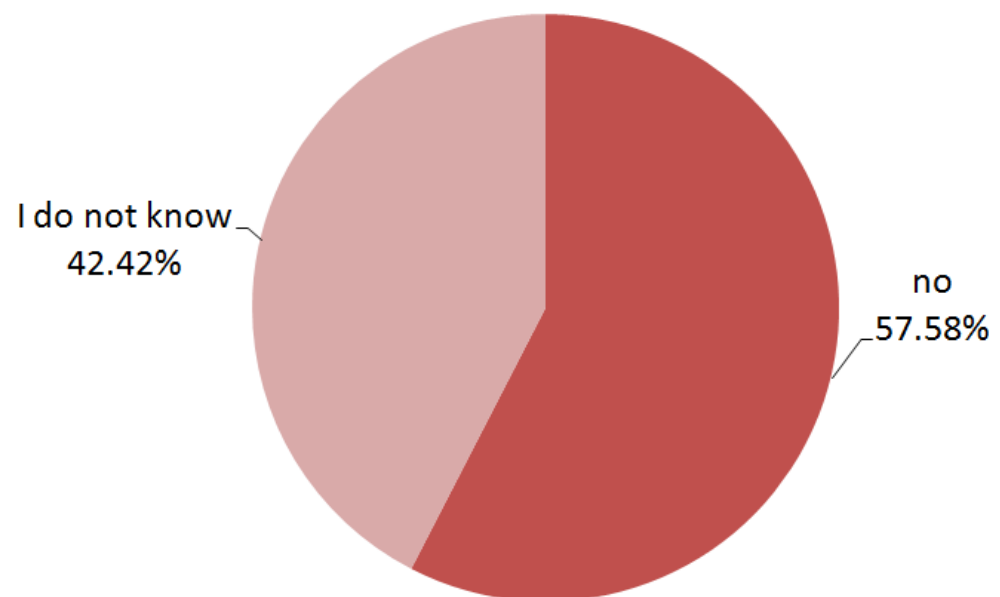




**Figure 6.** Answers to the questions: (a) Do you have a 3D printer at home? (b) Where in your home is the printer located?

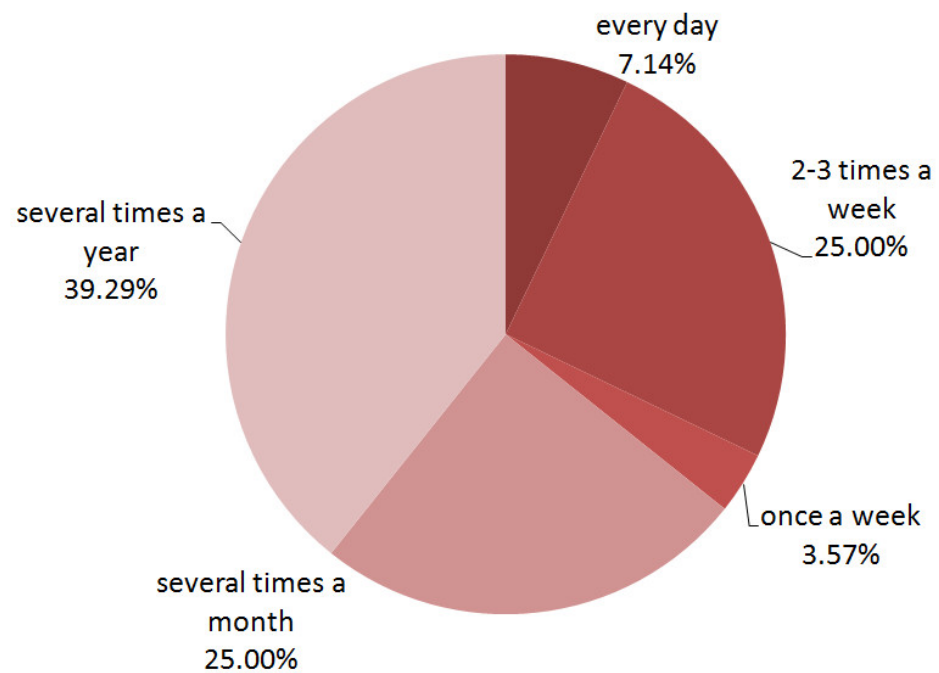
As printers are readily available and inexpensive, with those with open print chambers being the cheapest, more than 70% of the respondents use printers with an open print chamber.

The respondents do not pay much attention to pollution that comes out of the printer during additive manufacturing. Over 57% of the respondents do not use exhaust or HEPA filters when printing and the rest do not know if their printers have such filters, Figure 7.



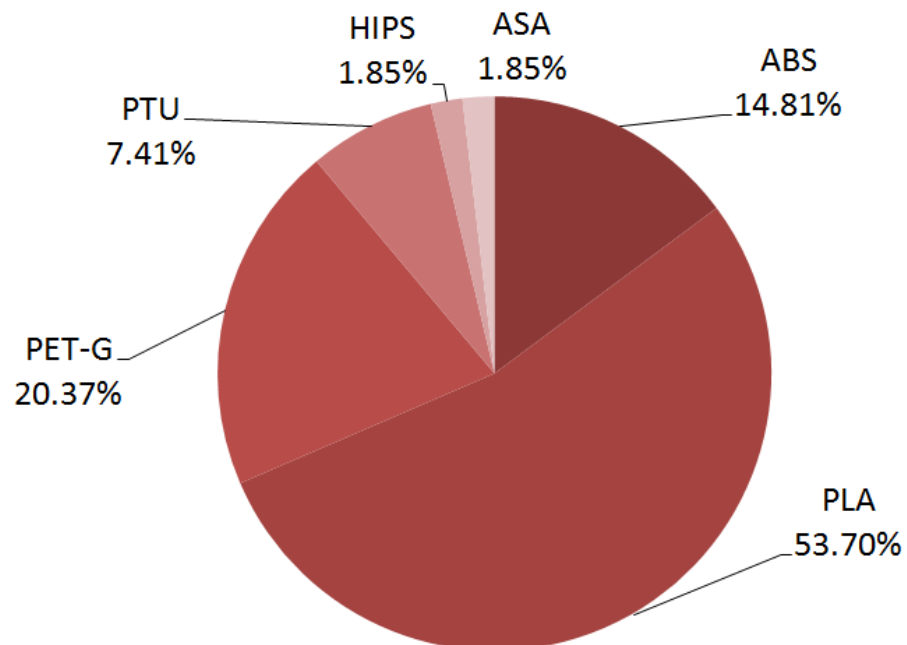
**Figure 7.** Answer to the question: Does the printer you use have a HEPA or other exhaust filter?

The responders indicated that they used 3D printers often or very often. Additionally, 30% of the respondents print several times a week, with over 7% of them printing every day; see Figure 8.



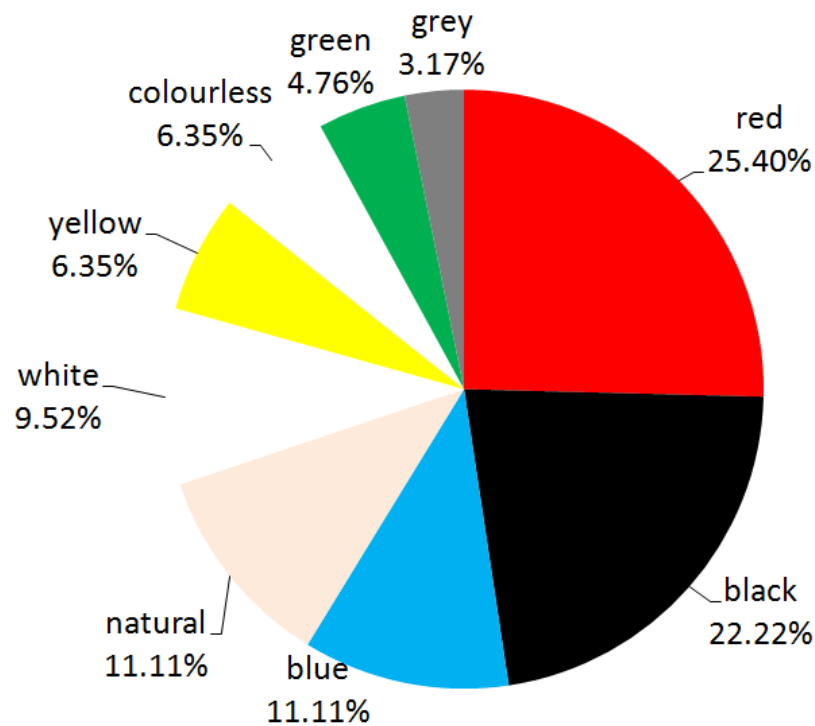
**Figure 8.** Answer to the question: How often do you use the printer?

The most common filament used by the respondents is PLA. It was indicated by over a half of the respondents; see Figure 9. Other frequently used materials are PET-G—20% and ABS—over 14%.



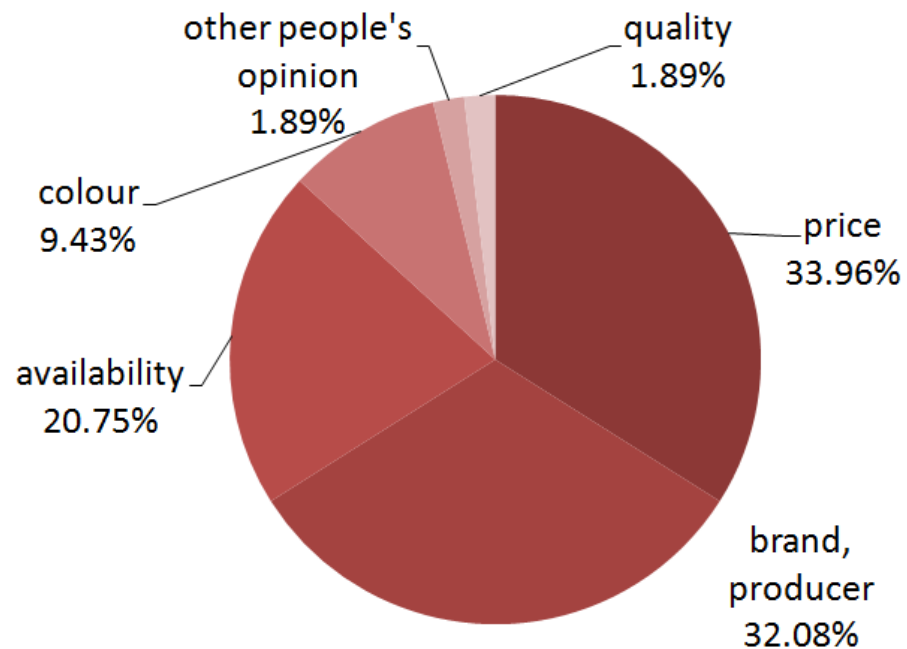
**Figure 9.** Answer to the question: What filament do you often use in printing?

Transparent materials are the most neutral when it comes to the release of noxious fumes, but the respondents indicated that they very rarely printed in this colour—only around 6%; see Figure 10. The most commonly used colour in 3D printing is red, followed by black which is the most polluting and harmful due to its staining with soot.



**Figure 10.** Answer to the question: Which colour do you most often use in printing?

The factors which guide 3D printer users as they buy filaments are price and filament brand, Figure 11. Other important aspects are availability and colour.



**Figure 11.** Answer to the question: What are you guided by when choosing the filament?

On average, it takes between two and six hours to produce objects by means of a 3D printer; see Figure 12. In total, 25% of the respondents said they printed for three hours, 20% of the respondents printed for five hours and 20% of the respondents printed for more than six hours. Given that the majority of the respondents have placed the printer in a room where they spend most of their time or sleep, this is not good for their health.

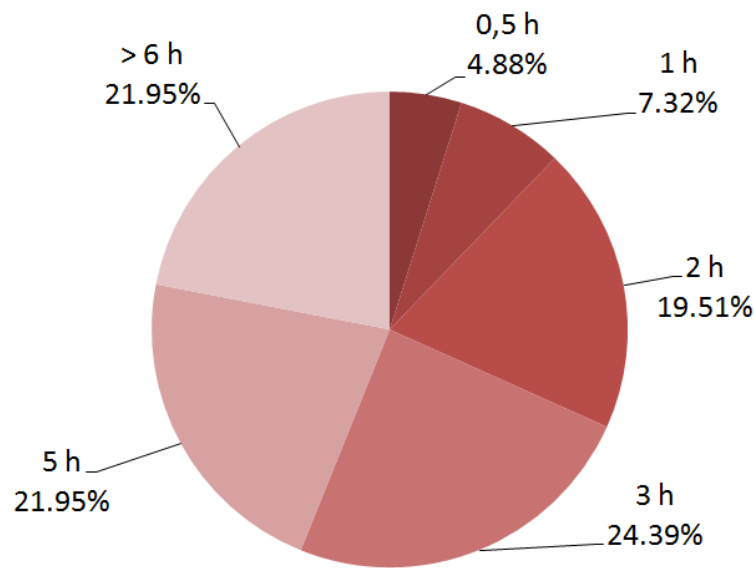


Figure 12. Answer to the question: How long does 3D printing take?

All respondents who print on closed-chamber printers (about 30% of respondents in this study) stated that when they opened the door of the 3D printer, they felt warm air pouring out on their face. This may indicate the possibility of short-term, but significant, exposure to harmful compounds accumulated in the working chamber during the manufacturing process.

The results of the survey prompted the authors to conduct a simulation study to determine how volatile organic compounds escaped from the printer during additive manufacturing and how they circulated around the printer operator.

Tables 7 and 8 present a simulation of pollutants emitted from 3D printers. Table 6 presents a simulation of pollutants emitted onto the operator standing in front of the printer. Table 7 presents a simulation of pollutants emitted onto the operator leaning in front of the printer. Assuming that the density of pollutants emitted from the printer is the same as ambient density, after approximately 1 s fractions of pollutants from the printer reach the nose and head of an operator leaning over the printer, and after 1.5 s fractions from the printer reach the nose and head of a standing operator. After about 2.5 s, both the standing operator standing and the leaning operator are completely enveloped in the pollutants emitted from the printer.

Table 7. Simulation of the volumetric concentration of dust fractions emitted from a 3D printer onto a standing operator.

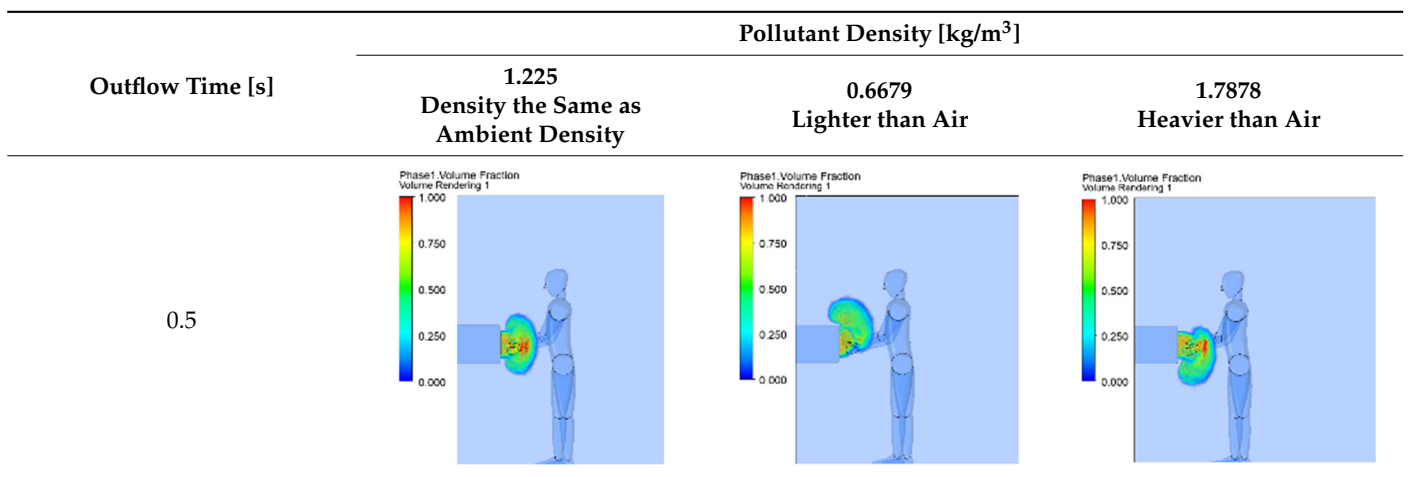
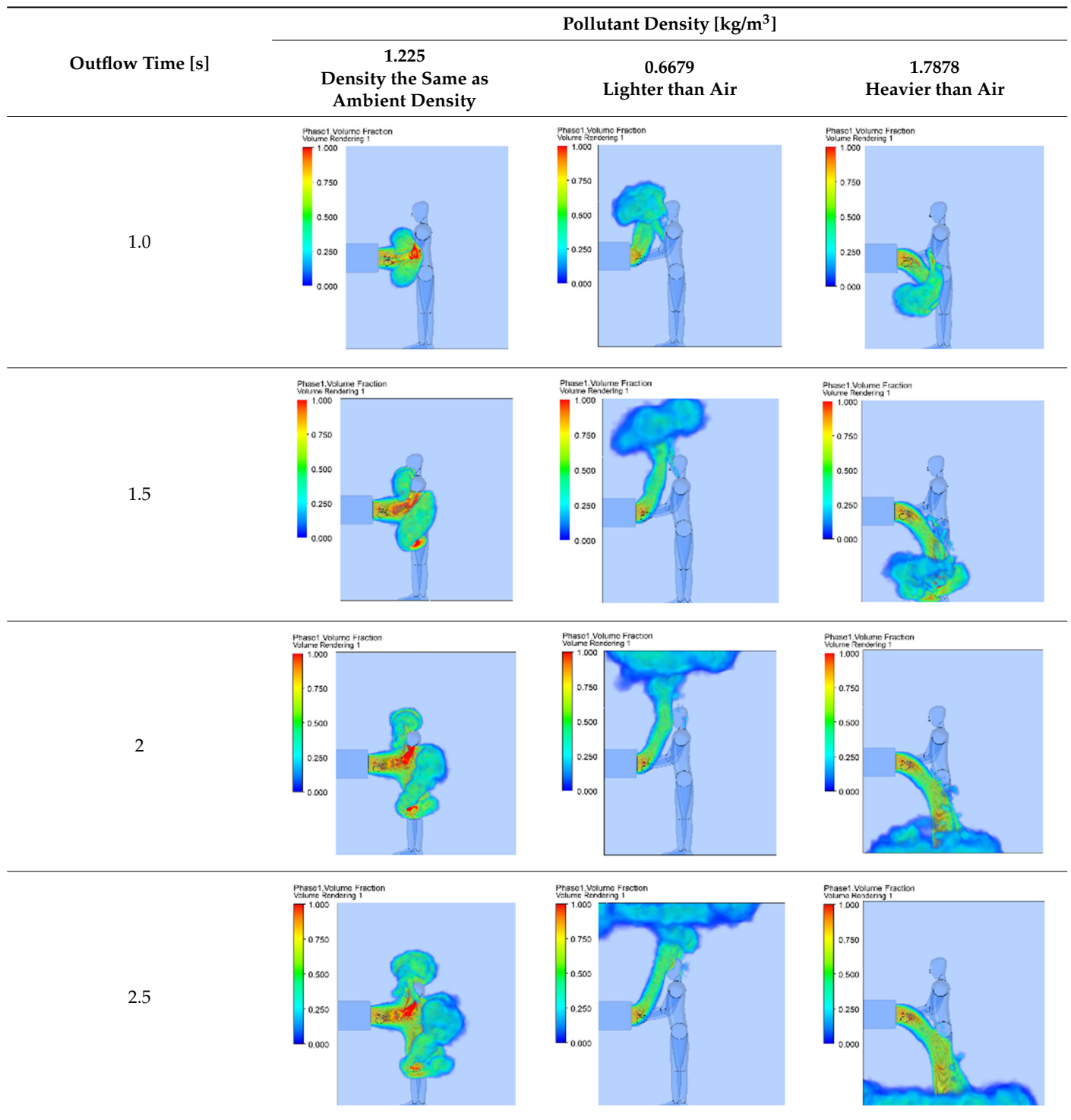
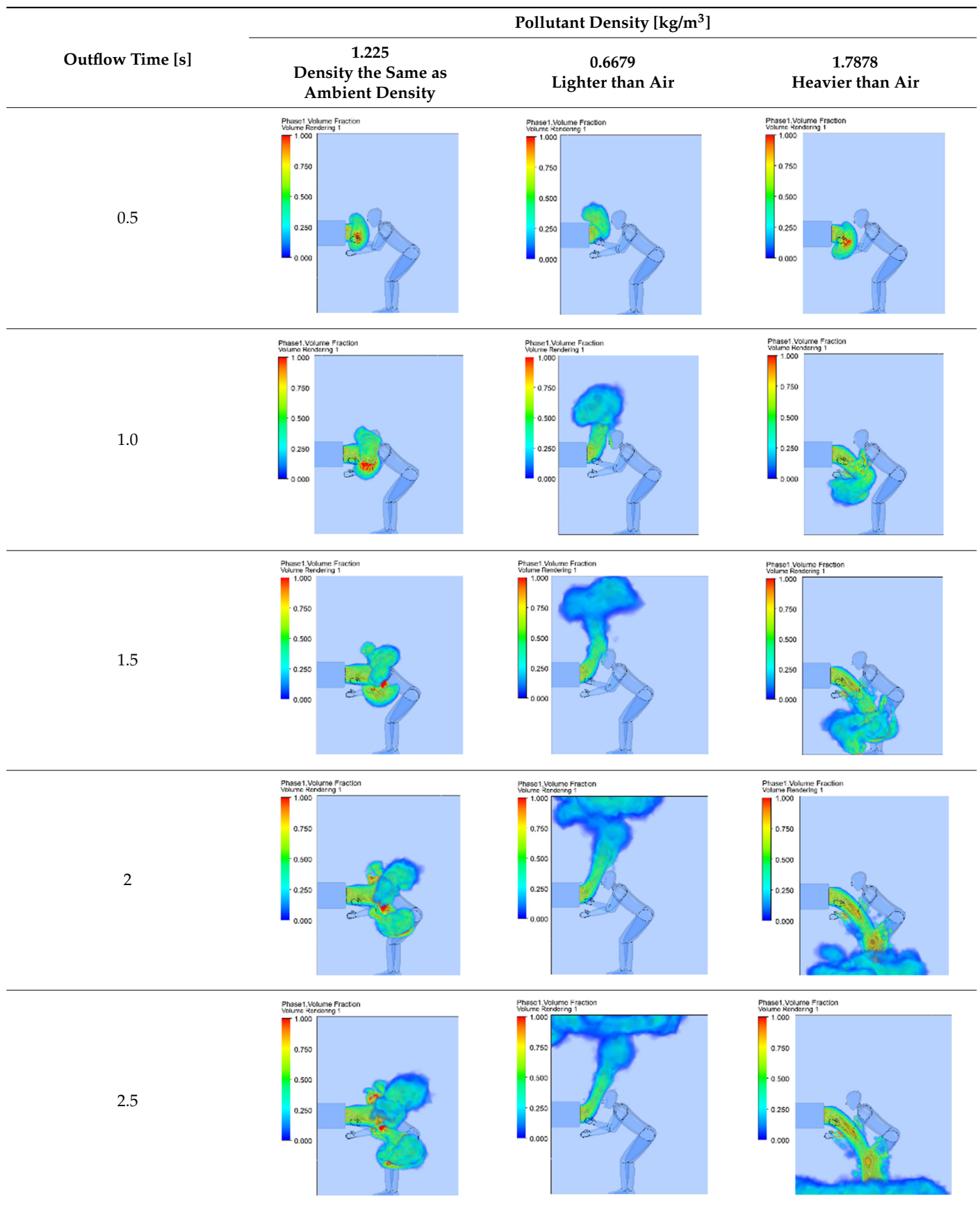


Table 7. Cont.





**Table 8.** Simulation of the volumetric concentration of dust fractions emitted from a 3D printer onto a leaning operator.



Simulations of the emissions of the three pollutants from the additive manufacturing process indicate that the process poses a risk to the operator, whether the contamination falls or rises when the printer door is opened. It is reasonable to carry out three types of simulations for gases–pollutants with a density equal to air, lighter and heavier; this is directly related to the actual composition of these pollutants, as described above.

The printing process takes an average of several hours and during this time, in the closed chamber of the printer, contaminants accumulate and each time the door is opened, they come out. In the case of a printer farm (several printers in the same room), with printers printing simultaneously for several hours, the amount of the accumulated pollutants is even greater.

The simulations of pollutant emissions from printers indicate that the process is very fast. After opening the printer door, after about 1.5 s, the fractions of pollutants reach the nose and head of the printer operator. After about 3 s, the printer operator is completely surrounded by debris fumes from the 3D printer.

The simulated emission times are consistent with the feelings of printer operators who indicate that immediately after opening the door they feel a smell and a warm vapour (blast of pollution) on their face. The presented CFD simulation results show that, regardless of the operator's position in a room with standard gravity ventilation, a dangerous situation occurs after about 1.5 s. Therefore, it seems necessary for the printers to be equipped with an internal ventilation system equipped with filters whose task would be to change the direction of emission from the current door to the operator or to reduce it, and to clean the pollutants from harmful fractions.

#### 4. Conclusions

The simulation results presented here suggest the possible ways in which volatile organic compounds can spread during additive manufacturing around a 3D printer. Each case shows that—irrespective of pollutant density—the 3D printer operator is exposed to direct contact with harmful substances emitted outside the printer during the printing process or immediately after its completion. In order to obtain a numerical model fully representing the work environment, experimental studies should be carried out to validate the simulation results. To this end, a closed chamber measuring, for example, 1–2 m<sup>3</sup> should be constructed. A printer will be placed inside the chamber and samples will be taken in its close vicinity. Another test that can be carried out is a laser analysis of the printing process that will confirm the way in which pollutants are emitted from 3D printers. However, it is a case-by-case determination of the target concentration of chemicals in an additive manufacturing facility. In order to determine the concentration inside a given room, it is necessary to clearly indicate elements related to printing, such as the number of printers, printing material, printing parameters, and even the parameters of the manufactured item. In addition, information about the room itself is necessary, e.g., the cabin, air flow (both natural and forced), or the temperature in the room. Only the determination of all these factors makes it possible to unequivocally determine the risk caused by the emission of the identified compounds for an individual user.

The simulation tests presented above, as well as studies carried out by other researchers, confirm that pollutants are emitted from 3D printers. Therefore, in order to reduce the risk of the operators inhaling these pollutants, measures in the form of masks should be used to prevent pollutant inhalation. Mechanical extraction systems should also be installed to remove the pollutants outside the room/building. In addition, it is possible to use integrated filters (HEPA, carbon filters) to capture pollutants and then eliminate them later.

**Author Contributions:** Conceptualisation, A.K. and K.L.; methodology F.O.; validation, A.K., K.L. and F.O.; formal analysis, F.O. and K.L.; investigation, A.K., F.O. and K.L.; resources, F.O. and K.L.; data curation, F.O. and K.L.; writing—original draft preparation, A.K. and F.O.; writing—review and editing, A.K.; visualisation, A.K. and K.L.; project administration, A.K. All authors have read and agreed to the published version of the manuscript.

**Funding:** This research was funded by [the Polish Ministry of Science and Higher Education.] grant number [(0613/SBAD/4710)].

**Institutional Review Board Statement:** Not applicable.

**Informed Consent Statement:** Not applicable.

**Data Availability Statement:** Not applicable.

**Conflicts of Interest:** The authors declare no conflict of interest.

## Abbreviations

3D	Three-Dimensional
FDM	Fused Deposition Modelling
FFF	Fused Filament Fabrication
VOCs	Very Volatile Organic Compounds
VVOCs	Volatile Organic Compounds
SVOCs	Semi-Volatile Organic Compounds
ABS	Acrylonitrile Butadiene Styrene
ASA	Acetylsalicylic Acid
PLA	Poly(lactic Acid)
PET	Polyethylene Terephthalate
PET-G	High Density Polyethylene Terephthalate
HIPS	High Impact Polystyrene
PS	Polystyrene
LD50	Lethal Dose, 50%
LC50	Lethal Concentration, 50%
WHO	World Health Organization
CFD	Computational fluid dynamics
HEPA	High-Efficiency Particulate Air

## References

- Bernat, Ł.; Kroma, A. Application of 3D Printing Casting Models for Disamatch Forming Method. *Arch. Foundry Eng.* **2019**, *19*, 95–98. [[CrossRef](#)]
- Żukowska, M.; Górski, F.; Wichniarek, R.; Kuczko, W. Methodology of Low Cost Rapid Manufacturing of Anatomical Models with Material Imitation of Soft Tissues. *Adv. Sci. Technol. Res. J.* **2019**, *13*, 120–128. [[CrossRef](#)]
- Łukaszewski, K.; Wichniarek, R.; Górski, F. Determination of the Elasticity Modulus of Additively Manufactured Wrist Hand Orthoses. *Materials* **2020**, *13*, 4379. [[CrossRef](#)] [[PubMed](#)]
- Wierzbicka, N.; Górski, F.; Wichniarek, W.; Kuczko, W. Prototyping of individual ankle orthosis using additive manufacturing technologies. *Adv. Sci. Technol. Res. J.* **2017**, *11*, 283–288. [[CrossRef](#)]
- Kalaskar, D.M. *3D Printing in Medicine*; Woodhead Publishing: Soston, UK, 2017.
- Ahmad, N.; Gopinath, P.; Dutta, R. *3D Printing Technology in Nanomedicine*; Elsevier: Amsterdam, The Netherlands, 2019.
- Mitsouras, D.; Liacouras, P.C.; Wake, N.; Rybicki, F.J. RadioGraphic Update: Medical 3D Printing for the Radiologist. *RadioGraphics* **2020**, *40*, E21–E23. [[CrossRef](#)] [[PubMed](#)]
- Górski, F.; Wichniarek, R.; Kuczko, W.; Banaszewski, J.; Pabiszczak, M. *Application of Low-Cost 3D Printing for Production of CT-Based Individual Surgery Supplies*, *World Congress on Medical Physics and Biomedical Engineering*; Springer: Singapore, 2018; Volume 68, pp. 249–253. [[CrossRef](#)]
- Stephens, B.; Azimi, P.; Orch, Z.E.; Ramos, T. Ultrafine particle emissions from desktop 3D printers. *Atmos. Environ.* **2013**, *79*, 334–339. [[CrossRef](#)]
- Gu, J.; Wensing, M.; Uhde, E.; Salthammer, T. Characterization of particulate and gaseous pollutants emitted during operation of a desktop 3D printer. *Environment* **2019**, *123*, 476–485. [[CrossRef](#)] [[PubMed](#)]
- Zhang, Q.; Wong, J.P.S.; Davis, A.Y.; Black, M.S.; Weber, R.J. Characterization of particle emissions from consumer fused deposition modeling 3D printers. *Aerosol Sci. Technol.* **2017**, *51*, 1275–1286. [[CrossRef](#)]
- Davis, A.Y.; Zhang, Q.; Wong, J.P.S.; Weber, R.J.; Black, M.S. Characterization of volatile organic compound emissions from consumer level material extrusion 3D printers. *Build. Environ.* **2019**, *160*, 106209. [[CrossRef](#)]
- Zhang, Q.; Pardo, M.; Rudich, Y.; Kaplan-Ashiri, I.; Wong, J.P.S.; Davis, A.Y.; Black, M.S.; Weber, R.J. Chemical composition and toxicity of particles emitted from a consumer-level 3D printer using various materials. *Environ. Sci. Technol.* **2019**, *53*, 12054–12061. [[CrossRef](#)] [[PubMed](#)]

14. Bravia, L.; Murmura, F.; Santos, G. Additive Manufacturing: Possible Problems with Indoor Air Quality. *Procedia Manufacturing* **2019**, *41*, 952–959. [[CrossRef](#)]
15. Khaki, S.; Rio, M.; Marin, P. Monitoring Indoor Air Quality, Additive Manufacturing environment. *Procedia CIRP* **2020**, *90*, 455–460. [[CrossRef](#)]
16. Air Quality 3. In *Indoor Air Quality a Comprehensive Reference Book*; Elsevier: Amsterdam, The Netherlands, 1995.
17. Rymaniak, L.; Ziolkowski, A.; Gallas, D. Particle number and particulate mass emissions of heavy duty vehicles in real operating conditions. *MATEC Web Conf.* **2017**, *118*, 00025. [[CrossRef](#)]
18. National Center for Chronic Disease Prevention and Health Promotion (US) Office on Smoking and Health. The Health Consequences of Smoking—50 Years of Progress: A Report of the Surgeon General. 2014. Available online: <https://pubmed.ncbi.nlm.nih.gov/24455788/> (accessed on 15 October 2021).
19. International Agency for Research on Cancer. List of Classifications by Cancer Sites with Sufficient or Limited Evidence in Humans. Monographs. 2021, 1–130. Available online: <https://monographs.iarc.who.int/agents-classified-by-the-iarc/> (accessed on 15 December 2021).
20. Stämpfli, M.R.; Anderson, G.P. How cigarette smoke skews immune responses to promote infection, lung disease and cancer. *Nat. Rev. Immunol.* **2009**, *9*, 377–384. [[CrossRef](#)] [[PubMed](#)]
21. Available online: <https://inhalationsexualfrustration.wordpress.com/introduction/> (accessed on 15 December 2021).
22. Matuszek, K.; Hrycko, P.; Dworakowska, A. Results of energy-emitting tests for the upper combustion method. Can upper combustion help to reduce low emissions. *Rynek Instalacyjny* **2017**, 7–8, 45–47.
23. *Niosh Pocket Guide to Chemical Hazards*; Department of Health and Human Services, Centers for Disease Control and Prevention, National Institute for Occupational Safety and Health: Washington, DC, USA, 2005; DHHS (NIOSH) Publication No. 2005-149.
24. *Job Hazard Analysis*; OSHA 3071; U.S. Department of Labor, Occupational Safety and Health Administration: Washington, DC, USA, 2002.
25. Regulation of the Minister of Family, Labor and Social Policy of June 12, 2018 on the Highest Allowable Concentrations and Intensities of Factors Harmful to Health in the Work Environment, In Polish, Journal of Laws of 2018, No. 2018 Item 1286, 2018-07-03. Available online: <http://isap.sejm.gov.pl/isap.nsf/download.xsp/WDU20180001286/O/D20181286.pdf> (accessed on 10 November 2021).
26. Available online: <https://www.cdc.gov/niosh/pel88/npelname.htm> (accessed on 15 October 2021).
27. Hawley, C. *Hazardous Materials Monitoring and Detection Devices*, 3rd ed.; Jones & Bartlett Learning: Burlington, MA, USA, 2018.
28. Armando, B.; Laurie, A.N. *Hazardous Materials Chemistry*, 3rd ed.; Jones & Bartlett Learning: Burlington, MA, USA, 2018.
29. NCI, United States National Cancer Institute. Bioassay of styrene for possible carcinogenicity. *NCI Tech. Rep.* **1979**, *185*, 1–107.
30. Nicholson, W.J.; Selikoff, I.J.; Seidman, H. Mortality experience of styrene-polystyrene polymerization workers. *Scand. J. Work Environ. Health* **1978**, *4* (Suppl. 2), 247–252. [[CrossRef](#)] [[PubMed](#)]
31. Okun, A.H.; Beaumont, J.J.; Meinhardt, T.J.; Crandall, M.S. Mortality patterns among styrene-exposed boatbuilders. *Am. J. Ind. Med.* **1985**, *8*, 193–205. [[CrossRef](#)] [[PubMed](#)]
32. Sathiakumar, N.; Brill, I.; Delzell, E. 1,3-Butadiene, styrene and lung cancer among synthetic rubber industry workers. *J. Occup. Environ. Med.* **2009**, *51*, 1326–1332. [[CrossRef](#)] [[PubMed](#)]
33. X1 Steinle, P. Characterization of emissions from a desktop 3D printer and indoor air measurements in office settings. *J. Occup. Environ. Hyg.* **2016**, *13*, 121–132. [[CrossRef](#)] [[PubMed](#)]
34. Ansys Help. Available online: <https://ansyshelp.ansys.com> (accessed on 10 November 2021).