

Review

Vertical Farming Perspectives in Support of Precision Agriculture Using Artificial Intelligence: A Review

Riki Ruli A. Siregar ¹, Kudang Boro Seminar ^{2,*}, Sri Wahjuni ¹ and Edi Santosa ³¹ Department of Computer Science, IPB University Indonesia, Bogor 16680, Indonesia² Department of Agricultural Technology, IPB University Indonesia, Bogor 16680, Indonesia³ Department of Agronomy and Horticulture, Faculty of Agriculture, IPB University Indonesia, Bogor 16680, Indonesia

* Correspondence: kseminar@apps.ipb.ac.id

Abstract: Vertical farming is a new agricultural system which aims to utilize the limited access to land, especially in big cities. Vertical agriculture is the answer to meet the challenges posed by land and water shortages, including urban agriculture with limited access to land and water. This research study uses the Preferred Reporting for Systematic Review and Meta-analysis (PRISMA) item as one of the literary approaches. PRISMA is one way to check the validity of articles for a literature review or a systematic review resulting from this paper. One of the aims of this study is to review a survey of scientific literature related to vertical farming published in the last six years. Artificial intelligence with machine learning, deep learning, and the Internet of Things (IoT) in supporting precision agriculture has been optimally utilized, especially in its application to vertical farming. The results of this study provide information regarding all of the challenges and technological trends in the area of vertical agriculture, as well as exploring future opportunities.



Citation: Siregar, R.R.A.; Seminar, K.B.; Wahjuni, S.; Santosa, E. Vertical Farming Perspectives in Support of Precision Agriculture Using Artificial Intelligence: A Review. *Computers* **2022**, *11*, 135. <https://doi.org/10.3390/computers11090135>

Academic Editors: Rytis Maskeliunas and Robertas Damaševičius

Received: 6 July 2022

Accepted: 1 September 2022

Published: 8 September 2022

Publisher's Note: MDPI stays neutral with regard to jurisdictional claims in published maps and institutional affiliations.



Copyright: © 2022 by the authors. Licensee MDPI, Basel, Switzerland. This article is an open access article distributed under the terms and conditions of the Creative Commons Attribution (CC BY) license (<https://creativecommons.org/licenses/by/4.0/>).

Keywords: vertical farming; artificial intelligence; machine learning; deep learning; internet of things (IoT)

1. Introduction

The world population is increasing at an accelerating rate. According to a UN report, the world population is expected to reach around 8.5 billion by 2030 [1] and is even predicted to reach 9.7 billion by 2050 [2,3]. The challenges posed by reliable food demands will be influenced by various factors, including climate change, water scarcity, and limited land due to increasing urbanization [3]. Research on agriculture has become an important focus [4]. The smart farming model is an essential step towards sustainable agriculture [5], which applies intelligent technological innovations in agriculture by leveraging modern technologies, such as the Internet of Things platforms, fog/edge computing, cloud computing, and storage, all from the most advanced information and communication technologies (ICT) [6]. Vertical agriculture is the answer to the challenge of land and water shortages, including urban farming, which has limited access to land and water [7]. One of the goals of this research is to provide information about agricultural land use by applying the development of vertical farming models [8–10], and intelligent system technology in vertical crop production based on IoT [11–13], as well as processing data collected with the role of machine learning algorithms from various scenarios, such as intelligent irrigation in vertical land technology, predicting yields, monitoring growth, monitoring diseases, and proposing framework models on vertically integrated farmland effectively. They are all conducted to change the paradigm of the traditional agricultural industry into a modern agriculture format from the perspective of precision and smart agriculture [2,14].

Machine learning focuses on developing computational artificial intelligence methods that can access various types of data (text, numbers, images, video, and audio), and is supported by data communication technology capabilities with data streaming speed (velocity) using the data for self-learning [15].

The study also presents a framework that maps the activities defined in smart farming, the data sets or features used in the data modeling, and the machine learning algorithms used to analyze the features for each activity defined in the described stages of the chain and the farm sequences. Vertical farming offers many opportunities to combine advances in genetics with advances in environmental modification and to produce a guaranteed quality and quantity of crops regardless of the weather, soil conditions, or impacts of climate change [10]. This enables the opportunity of producing functional or specialized food from staple foods through environmental control and manipulation [16]. Vertical farming has various advantages over horizontal rice field farming, observed from the perspectives of environmental, social, and economic stability. New high-tech cultivation methods, including hydroponics, aeroponics, and aquaponics, largely challenge the need for soil-based agriculture for a wide variety of crops [17] and also present a viable option for growing crops in urban environments where the geographic footprint is limited and the demand for on-time product delivery always increases [8]. A research approach was taken to obtain the technology used to achieve this goal, at a low cost, by utilizing the Internet of Things (IoT) [18,19] and artificial intelligence [20] on machine learning techniques [15] to help transform big data into knowledge [21]. The IoT approach requires a set of sensor devices, including temperature, light, soil moisture, nutrition, and several other supporting sensors, which are monitored continuously and obtain data through the data transmission path where sensor data can be communicated wirelessly using microcontrollers and wireless modules to build intelligent and precise agricultural processes using IoT [22].

The main objective of this research is to introduce a model of vertical crop farming as an era of precision and intelligent agriculture as an embodiment of intelligent agriculture. Artificial intelligence methods are described that combine the processing of big data collected by IoT systems, the use of machine/deep learning in different vertical irrigation scenarios, as well as for yield predictions, monitoring growth and disease, and assessing sample quality. Vertical farming (VF) opens up a new era of intelligent agricultural engineering that has the potential to meet future food requirements. Looking at the current agricultural trends, VF can utilize all agricultural IoT devices in multiple dimensions. Applying agricultural technologies such as AI (artificial intelligence), machine learning, productivity, and quality factors will increase the efficiency of VF [23].

In Figure 1. The design of the proposed VF model represents a new era of intelligent agricultural engineering. The application of the Intelligent Internet of Things concept by combining artificial intelligence and machine learning algorithms, productivity, and quality factors will improve VF.

Intelligent system agriculture refers to data-driven agriculture, which can adaptively keep up with future developments by utilizing new technologies for the improvement of agricultural knowledge systems from the availability of larger amounts of data [24]. With the advancement of data management, smart agriculture is growing exponentially, and generating relevant data has become a key element in modern agriculture to assist users in decision-making [25]. The concept of data-centric agriculture has been promoted in several formats, such as Agriculture 4.0, Digital Farming, and Smart Farming, and was born from telematics and data management combined with the concept of precision agriculture to improve agricultural operational accuracy [26]. IoT in the context of agriculture refers to the use of sensors and other devices to transform every element and action involved in agriculture into data [27]. IoT is a model for developments in Agriculture 4.0 [28] and becomes one of the reasons why agriculture can produce a large amount of valuable information. The agricultural sector is expected to be heavily influenced by technological developments and innovations in IoT [6,29]. The big data concept applied to agricultural applications at the Consortium of International Agricultural Research Centers (CGIAR) uses big data [30].

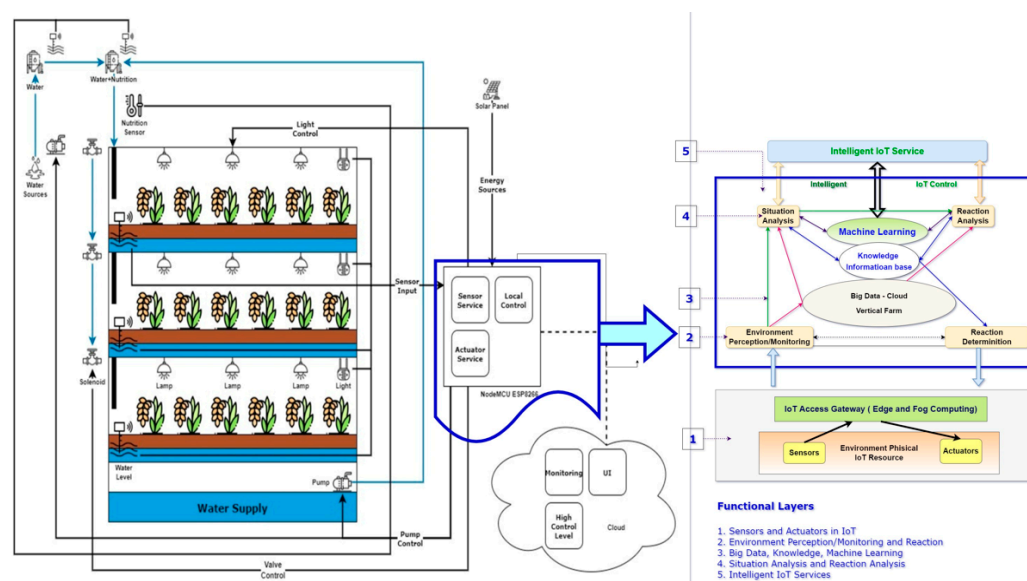

Figure 1. A conceptual architecture of smart vertical farming.

Data-based management in agriculture uses spatial- and time-based data measured from plants' soil or other parameters, data from sensors, and the decision stage involving pre-processing activities and an artificial intelligence algorithm approach to get the appropriate data and helps in making and creating the right decisions [25].

2. Research Methodology

The approach uses a systematic literature review (SLR), i.e., a method of managing information sources from related research according to predetermined topics [31]. In this study, SLR was conducted to determine the feasibility and study of smart farming technology in vertical farming. The research searched using the term: "smart agriculture" is then inserted with the term: "vertical agriculture" which will appear in the title, abstract, and keywords of articles with approaches to "artificial intelligence", "machine learning", "deep learning", "IoT" and intelligent algorithms applied to agricultural systems. This paper uses selected reporting items for systematic review and meta-analysis (PRISMA) as one of the SLR approaches. PRISMA is a way to check the validity of articles for literature review or systematic review [31]. PRISMA, in this study, evaluates a systematic review or meta-analysis composed of a checklist of items as a systematic review or meta-analysis. Steps for preparing a checklist item for a systematic review and meta-analysis:

1. Title: confirm and identify as systematic review and meta-analysis.
2. Abstracts are structured; namely, there is a background, methods, results, and conclusions.
3. In the Introduction section, discover the urgency of the systematic review or meta-analysis and the purpose of the systematic review or meta-analysis.
4. The method of conducting a literature search process is searching for sources of literature portals, describing inclusion and exclusion criteria from articles or research, representing the number of articles obtained during the initial search, and then the reasons for exclusion, so how many manuscripts can be accepted.
5. Results describe with a diagram the selection process of the article.
6. Discussion section on the relevance and plausibility of the findings. The limitations they face start from the study selection process to the limitations in the process.
7. Conclusions from findings from systematic reviews and/or meta-analyses are brief, concise, and clear.

PRISMA explanation flow can be seen in Figure 2.

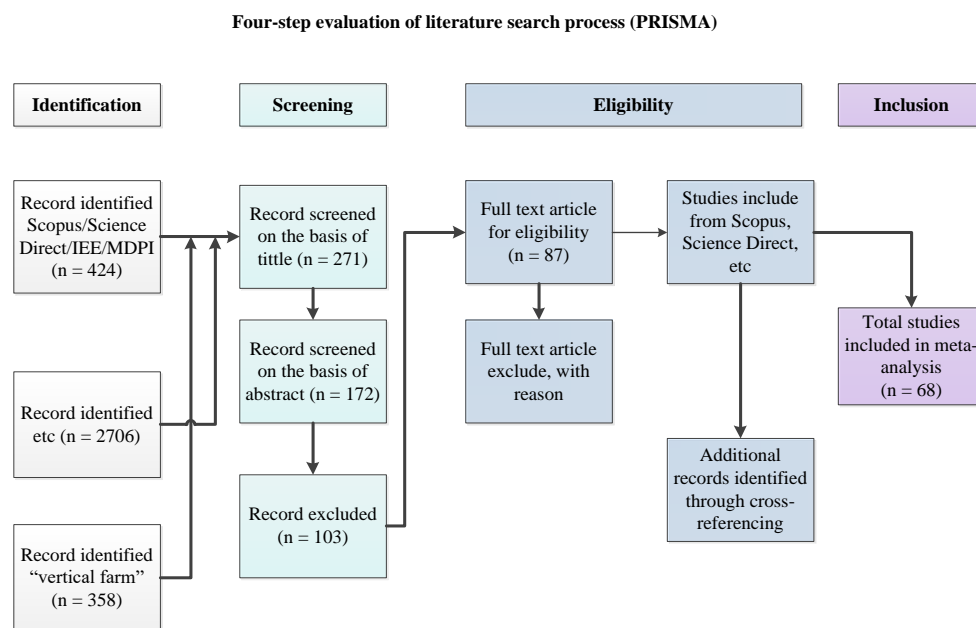

Figure 2. Literature review with four stages of PRISMA evaluation.

2.1. Literature Review

The survey was conducted by looking at the global scope of innovations related to vertical smart agriculture using machine learning with the evaluation carried out in four stages including identification, screening, feasibility, and inclusion [32]. Literature review in perspective was completed by identifying, evaluating, and interpreting the scope and results of related and relevant research, which is shown in Table 1.

Table 1. Systematic observation of the literature review.

Research question	<ol style="list-style-type: none"> 1. What types of digital technology are used for vertical farming and smart farming? 2. How are technological developments and intelligent algorithm models applied in the context of the tools, the technologies used, the level of reliability, and the type of farming applied? 3. What are the key opportunities and barriers to implementing vertical farming for smart farming?
Selection literature	<ol style="list-style-type: none"> 1. Journal articles, original papers, review papers, conference papers 2. Periodic publication: 2016–2022. 3. Potential answers to research questions. 4. Scopus indexed articles by listing title, affiliation, year, source, abstract, and quartiles (Q1–Q4 and Non–Q). 5. The focus of the literature is on the development of vertical land models with intelligent systems in the concept of smart farming based on artificial intelligence/machine learning algorithms. 6. Publications are written in English.
Literature source	Scopus, IEEE Xplore, Multidisciplinary Digital Publishing Institute (MDPI), Science Direct.
Search keyword	((“Farming OR Agriculture”) AND (“Vertical agriculture” OR “Vertical Farming” OR “Intelligent Farming” OR “Smart Agriculture” OR “Precision Agriculture” OR “Smart Farming” OR “Greenhouse ” OR “Internet of Things” OR “IoT” OR “Cloud Computing” OR “Edge Computing” OR “Wireless Sensor Networks ” OR “Artificial Intelligence ” OR “Big Data ” OR “Data Analytics ” OR “Data Science ” OR “Cyber-Physical System ” OR “Robotics ” OR “Computer Vision ” OR “Machine Learning ” OR “Deep Learning ” OR “Data Integration ” OR “Supervised learning ” OR “Unsupervised Learning ” OR “Decision Support System ” OR “fuzzy”))

Figure 2 explains the criteria that have been mentioned and refer to Table 1 on the Research question, Selection literature, Literature sources, and Search keywords with four steps of PRISMA evaluation:

1. **Identification:** The amount of data from searches in the Scopus index database, MDPI, science direct, etc., is 424. The amount of data from other sources (recommendations from experts/manual searches/reports/news) is 2706, and the amount of data that appears with the keyword “vertical farm” is 358.
2. **Screening:** The total number of data identified and then the amount of data after duplicate data was deleted and indexed by Scopus and deemed irrelevant was 271. The number of data released after the selection based on the title and abstract was 172. The exclusions of search results based on title and abstract are: “vertical farm objects”, “use of artificial intelligence”, “machine learning and deep learning methods for vertical farms”, “IoT base farming”, “literature studies”, and “published outside 2016–2022”.
3. **Eligibility:** The amount of data in the form of a full-text article and excluded because it does not meet the criteria based in Table 1.
4. **Inclusion:** The amount of data synthesized in the systematic qualitative review and the complete study included in the meta-analysis selected 68 datasets.

2.2. Research Trends in Vertical Agriculture

Based on the distribution of 68 articles from 2016 to 2022, it can be seen in Figure 3, that 32% of the scientific publications occurred in 2021 and 25% in the first six months of 2022. Figure 4 shows the distribution of scientific articles indexed by reputation at the quartile level (Scopus). This trend seems to always increase in the application of digitalization of vertical agriculture by utilizing artificial intelligence [33].

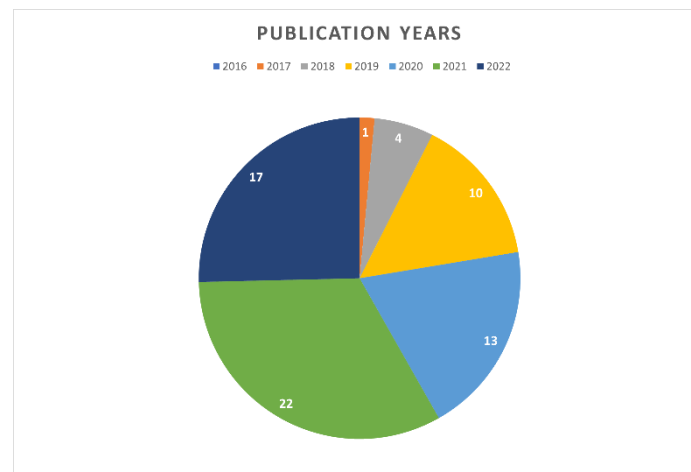

Figure 3. Distribution of literature from 2016 to 2022.

A literature review focusing on vertical farming with AI has been carried out from several existing papers. In relating the novelty of this study to other surveys, a comparison of surveys similar to those available is carried out in Table 2. Most public surveys present urban farming technologies, vertical farming, IoT, automation, and AI reviews. However, this study concentrates on quantitative research related to vertical farming models with AI.

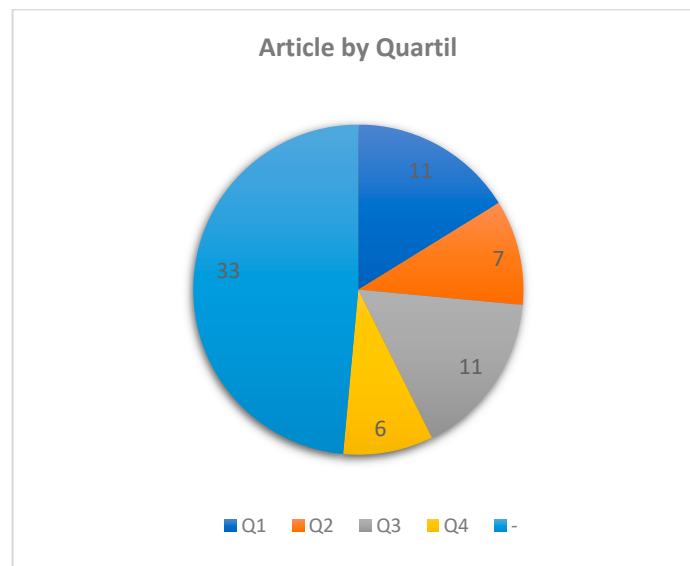

Figure 4. Distribution of articles by 2016 to 2022 quartiles.

Table 2. Comparison with Other Surveys in the Literature.

Reference	Research Content	Our Paper
[34]	The study reviews various new and disruptive technologies introduced in urban farming: the internet of things, automation, artificial intelligence, robotics, blockchain, digital twins, renewable energy, genetic modification, additive manufacturing, and nanotechnology. Each technology is discussed in terms of its application, advantages, and disadvantages	In this paper, various emerging and disruptive technologies for urban agriculture are reviewed and assessed. Based on the literature from 2015 to 2021, IoT, automation, and AI do not cover the survey of vertical farming models.
[35]	This paper presents an overview of the various practices and aspects that can be or are currently being automated, using robotics, IoT, and Artificial Intelligence (AI) more productively.	What distinguishes it has not been reviewed in more detail from the survey on the vertical farming model using AI and IoT.
[36]	This study aims to monitor and control vertical farming by scheduling agricultural activities by solving Job-shop scheduling problems. A genetic Algorithm was developed to monitor farm locations remotely.	The results of this study are not a review related to vertical agricultural survey technology in the development of AI and IoT.
[37]	This survey discusses a comprehensive overview of the USVF concept using various techniques to increase productivity and the type, topology, technology, control system, social acceptance, and novelty benefits of the paper.	Have not focused on the relevant technology, have not discussed some of the AI algorithms that have been used

Table 2. Cont.

Reference	Research Content	Our Paper
[23]	Urban smart vertical farming (USVF) uses various techniques to increase productivity and its types, topologies, technologies, control systems, social acceptance, and benefits. This study focuses on multiple issues, challenges, and recommendations in systems development, vertical farm management, and modern technology approaches	Focus on IoT Architecture and LoRa communication. We have not discussed some of the AI algorithms that have been used in vertical farming.

In Table 2, many studies have been conducted on using AI, machine learning, deep learning, and IoT in vertical farming. However, none of these studies focus on using smart vertical farming for food crops such as paddy, corn, and wheat. Study research on vertical agricultural land using artificial intelligence, machine learning, and deep learning on staple crops such as rice, wheat, or corn is one of the new opportunities for food crop agriculture research on vertical land that can be controlled and monitored at any time. Potential research gaps in vertical farming with artificial intelligence are:

1. The challenges of indoor rice production compared to indoor vegetable production.
2. More complex growth involves vegetative, reproductive, and ripening phases.
3. More precise and complex water, nutrition, and lighting management.
4. More extended production period from planting to harvest.

The novelty of this study is to address a new opportunity to study the development of intelligent and precise indoor production for rice crops using vertical farming. This is the novelty of this research.

Based on the distribution of 68 articles from 2016 to 2022 shown in Figure 3, 32% of scientific publications in the last six years will be published in 2021. Figure 4 shows the distribution of scientific articles indexed by reputation at the quartile level (Scopus), with details Q1 16% (11), Q2 10% (7), Q3 16% (11), Q4 9% (6), and No Q 49% (33). The trend of the number of research and publications is constantly increasing in the implementation of digitalization of vertical agriculture by utilizing artificial intelligence [33]. In detail, the publications mentioned in the agricultural object types are shown in Figure 5.

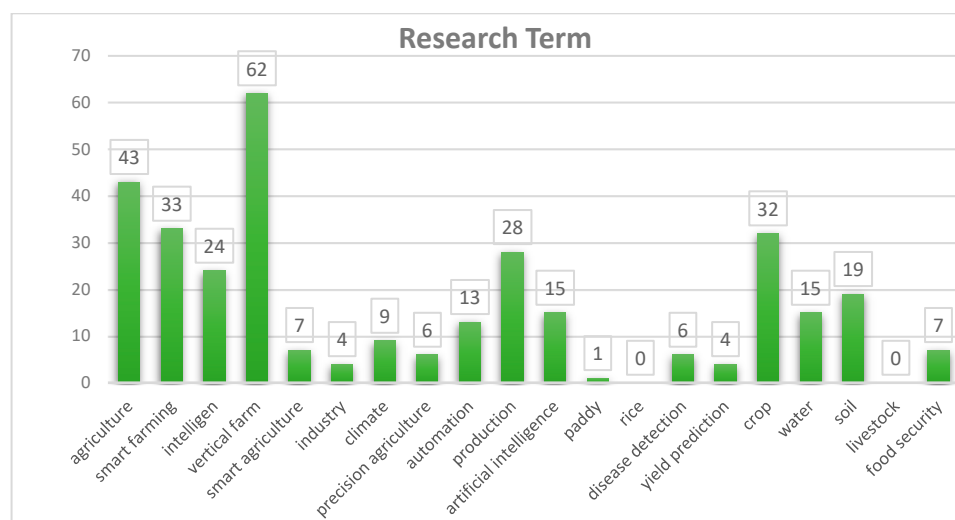

Figure 5. Numbers of articles in the research sample that mention specific research terms.

Figure 5 shows the number of objects in the agricultural sector based on a literature study that applies smart farming. The type of agricultural object refers to the approach taken such as using soil or soilless media, developing smart farming concepts, precision, automation, and disease detection. Based on the occurrence frequencies of specific terms is that the vertical farm object in the selected article is the most dominant discussion. Furthermore, from the distribution of the 68 selected articles, in Figures 6–8, the trend of publications indexed in the reputable database that the vertical agriculture theme from 2016 to 2022 is always increasing.

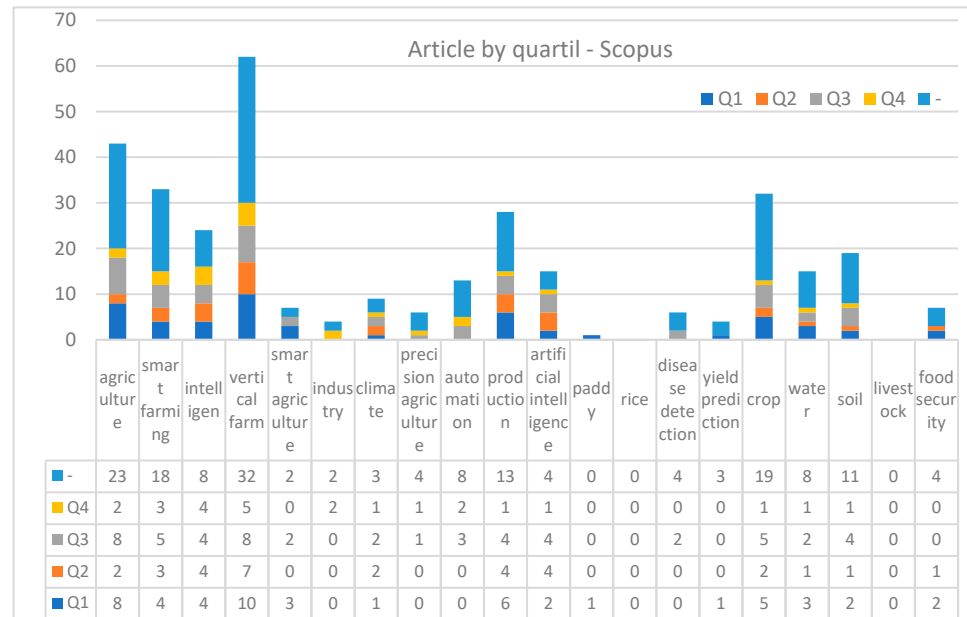

Figure 6. Distribution of objects in the vertical farm of 68 selected articles by quartiles (Scopus).

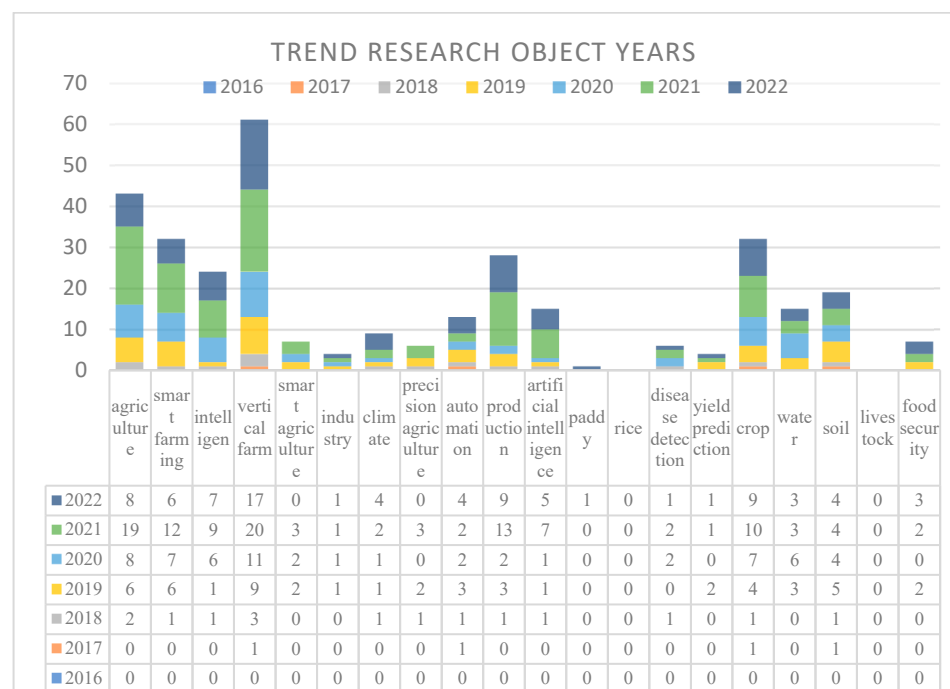

Figure 7. Distribution of trends in vertical farming of 68 articles selected by year.

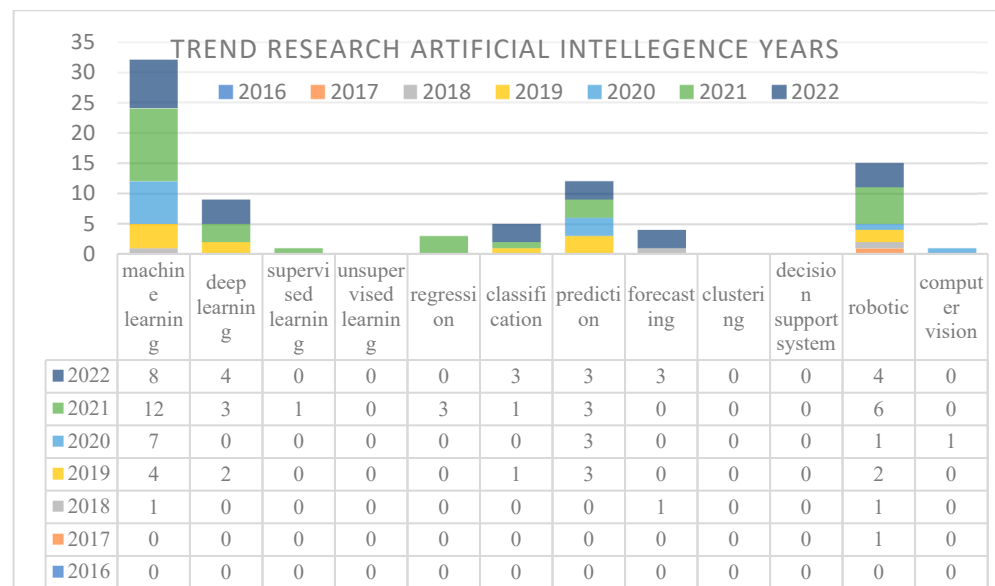

Figure 8. Distribution of artificial intelligence trends in vertical farming of 68 articles selected by year.

2.3. AI Research Trends in Vertical Farming

Artificial intelligence (AI) involves the development of theories and computer systems capable of performing tasks that require human intelligence, such as sensory perception and decision making [38] which are combined with Cloud Computing, IoT, and big data. AI, especially in machine learning (ML) and deep learning (DL) aspects, is considered one of the main drivers behind the digitalization of smart agriculture. This technology has the potential to increase crop production and improve real-time monitoring, harvesting, processing, and marketing [39]. Several intelligent farming systems were developed that use ML and DL algorithms to define various parameters such as smart irrigation, lighting, weed detection, yield prediction, or disease identification. The type of vertical farming proposed to be a smart farm has been reviewed in several kinds of literature as well as reviews conducted with a focus on artificial intelligence [2,4]. One of the findings of this review is that machine learning and deep learning algorithms are proven to be better in providing high-accuracy quality results compared to other algorithms in terms of accuracy when applied to various agricultural problems, such as disease detection and identification, fruit or crop classification, and fruit counting among other domains [40]. Figure 9 shows the trend of the artificial intelligence approach based on a literature study.

Figure 9 describes the research trend of the vertical farming model structure taken from 68 related articles, under research studies on types and structures of vertical farming development with soil use, hydroponics, energy use, and indoor lighting systems. Study analysis shows that most of the research focuses on open farming systems and large areas of land, compared to research on vertical farming systems. This is due to the high costs associated with developing intelligent technologies and systems which typically also involve hardware installation. The centralized network subscriptions and software packages are required to facilitate data processing, management of IoT devices and equipment, and knowledge exchange, which in turn increases operational costs.

Based on the literature study described in Table 3, it was found that AI and ML techniques are still rarely explored in indoor vertical farming systems, whether they are using soil media or without, especially for hydroponics, aquaponics, and aeroponics [32]. There are only a few publications listed in the table related to intelligent system models with ML techniques. Unlike the case with artificial intelligence in agricultural applications that are not vertical land models, many explorations with machine learning in agriculture are classified into three categories, i.e., supervised learning, unsupervised learning, and reinforcement learning [34]. ML techniques and algorithms that have been widely implemented in the agricultural sector are for prediction of crop yields, disease and weed detections,

weather prediction (rainfall), estimation of soil properties (type, moisture content, pH, temperature, etc.), water management, determination of the optimal amount of fertilizer, as well as livestock production and management [15].

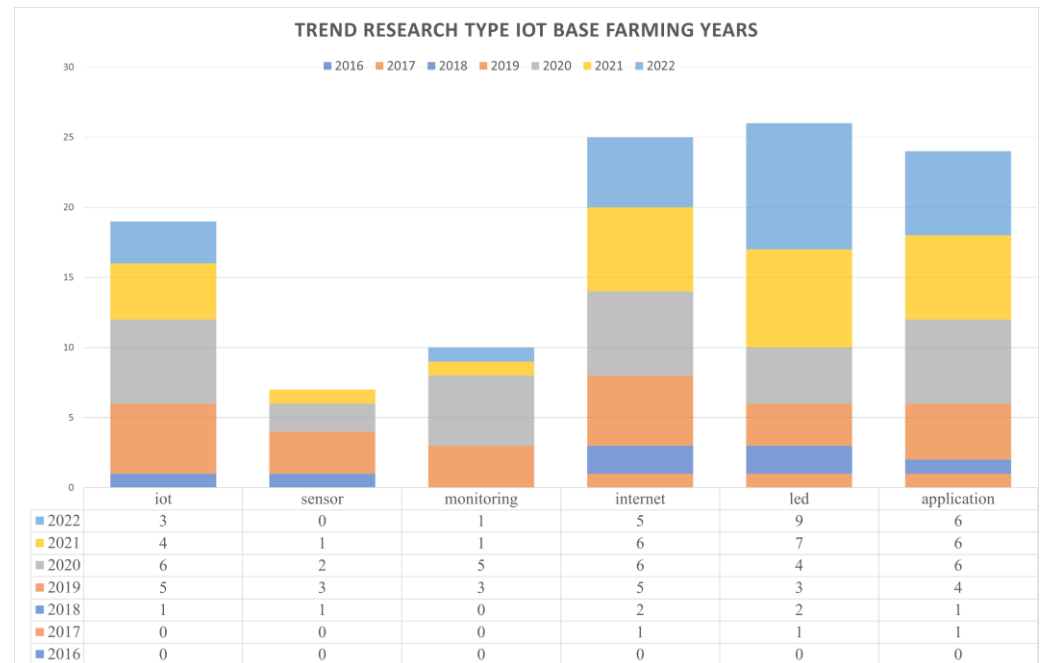

Figure 9. Distribution of IoT trends in vertical farms from 68 selected articles by year.

Table 3. Studies in the use of AI for the development of intelligent vertical agriculture.

Model ML/Algorithms	Approach	Application	Crops/Area	Observed Features	Article
Genetic Algorithm and Job-Shop Scheduling	Presenting an efficient method based on the genetic algorithm developed to solve the proposed scheduling problem	Indoor vertical farming	fruits	Control and increase food production and predict harvest time	[36]
RNG k-epsilon model	RNG k is implemented to consider the impact of air pressure and barriers in the computing domain	Indoor vertical farming	Vegetable plant	A three-dimensional numerical model for optimizing airflow and heat transfer in a vertical farm space system taking into account carbon dioxide consumption, and oxygen production.	[41]
Fuzzy Logic	Fuzzy logic handles certainty and fuzzy evaluation based on the distance from the mean solution (EDAS) method assists in the system evaluation decision-making process.	Hydroponics system in vertical farming	Planting system without soil	Number of crops type, production volume, attractiveness, sustainability, flexibility, workforce requirement, stock-out cost, transportation cost, and investment cost	[42]

Table 3. Cont.

Model ML/Algorithms	Approach	Application	Crops/Area	Observed Features	Article
Fuzzy Logic, WEDBA (Weighted Euclidean Distance Based Approximation) and MACBETH (Measuring Attractiveness by a Categorical Based Evaluation Technique)	The WEDA and MACBETH methods were used to rank three smart farming alternatives in urban areas	Smart system in hydroponic vertical farming	Planting system without soil	Venture capital attractiveness, effective manufacturing process, workforce requirement, security, space requirement, R&D capabilities, expansion opportunities, investment, and maintenance cost	[43]
Integer Linear Program (ILP)-Crop Growth Planning Problem (CGPP)	Present four mathematical models for planning the growth of crops in a vertical farming system, which are strengthened using variable fixing and valid inequalities.	Vertical farm	Leaf vegetables	Machine scheduling and configuration	[44]
Mixed-Integer Linear Programming (MIP)	Three approaches using polynomial, pseudo, and hybrid variables (polynomial end pseudo)	Vertical farming elevator energy minimization problem (VFEEMP)	Vertical agriculture energy source	Driving energy in vertical farms	[45]
Computer vision—Machine learning	Viola-Jones algorithm and Haar-like feature extraction method for the machine learning	Detect spot disease in tomatoes	Telemetry vertical farming	Detection of spot disease in tomatoes is designed using 377 images of infected tomatoes	[46]
Multi-criteria decision-making (MCDM) and Pythagorean fuzzy set (PFS) Pythagorean Fuzzy Choquet Integral (PFCI μ)	Multi-criteria decision-making (MCDM) framework to assess the VF systems. A novel Pythagorean fuzzy set (PFS) with Choquet Integral model integrated is recommended for VF technology evaluation	Vertical farming feasibility evaluation framework	Comparative study of agricultural vertical land	Evaluate the urban farming framework to choose the right strategy and change the strategy	[47]
Fuzzy Logic	The fuzzy logic control will be based on the state of charge (SoC) of each node. A wireless sensor network (WSN) will provide two-way communication between nodes and coordinators.	Development and design of power generation and distribution optimized for vertical farming.	Power generation and distribution for vertical farming	New renewable energy in vertical farming	[48]
Support Vector Machine (SVM), Decision Tree (DT), and Neural Network (NN)	Three categories of AI models commonly used in soil management and agricultural production to enable smart farming to be introduced	Multiphonics Vertical Farming (MVF) system	Leaf vegetable	The study discusses how AI is adopted in soil management and MVF for tasks including classification, detection, and forecasting	[49]

Table 3. Cont.

Model ML/Algorithms	Approach	Application	Crops/Area	Observed Features	Article
Feed Forward Neural Network	Regression type feed-forward deep learning a neural network has been utilized	Greenhouse	Tomatoes	The growth of the plants is checked every 24 h and based on the growth, the necessary conditions are provided for the target growth	[50]
Machine learning-computer vision	Automatic method for extracting phenotype features, based on CV, 3D modeling and deep learning. From the extracted features, height, weight, and leaf area were predicted and validated with ground truths obtained manually	Vertical farms with artificial lighting (VFAL)	Vegetables	Methods for vision-based plant phenotyping in indoor vertical farm under artificial lighting. This method combines 3D plant modeling and deep segmentation of higher leaves, for 25–30 days, associated with growth	[51]

2.4. IoT Research Trends in Vertical Farming

IoT refers to interconnected computing devices, sensors, actuation equipment, and machines connected to the internet, each with a unique identity and ability to perform remote sensing and monitoring [52]. IoT reference model architecture has six layers, i.e., physical devices and controllers, connectivity/network, edge/fog computing, data accumulation, data abstraction, and application layer (user interface) [4]. The development of IoT applications in vertical farms requires the support of hardware and software infrastructure as well as communication media to ensure the interconnection of various heterogeneous components [53]. This support is one of the vertical efforts of agriculture in Industrial Technology 4.0, namely the cyber-physical system (CPS) which refers to a distributed system that combines physical devices with communication networks automatically. CPS benefits from various existing technologies, namely intelligent agents, IoT, cloud computing, computer vision, big data, ML, and DL [54].

A wireless sensor network (WSN) is considered a type of technology used in IoT systems. It can be defined as a group of spatially distributed sensors for monitoring the physical conditions of the environment, temporarily storing the collected data, and transmitting the collected information at a central location [6,55]. The results of the study that IoT is applied significantly in agriculture, due to its broad purpose and function in monitoring, tracking, tracing, agricultural intelligent machines, and precision agriculture [52], which is one of the main research objectives in the smart farming approach. However, there are still few studies that conduct some research on vertical agricultural land by considering data reliability, interoperability, and IoT smart systems in the development of the intelligent vertical farming system. This can be seen in Figure 10; the trend of IoT-based agricultural research that focuses on the research of IoT applications, monitoring (water, temperature, humidity, pH), and lighting systems.

The results of the studies from previous research on IoT applications on vertical farms in Table 4 have been developed for the management of various services on vertical farms. Most systems are still classified as prototype and conceptual. Considerable research has been reported on greenhouses, but none was found that is relevant to vertical farming. The application of IoT in vertical farming has attracted significant research because its application has potential in various fields, such as the application of the CPS model to vertical farming applications, and is a challenge because it requires the right hardware and software [56].

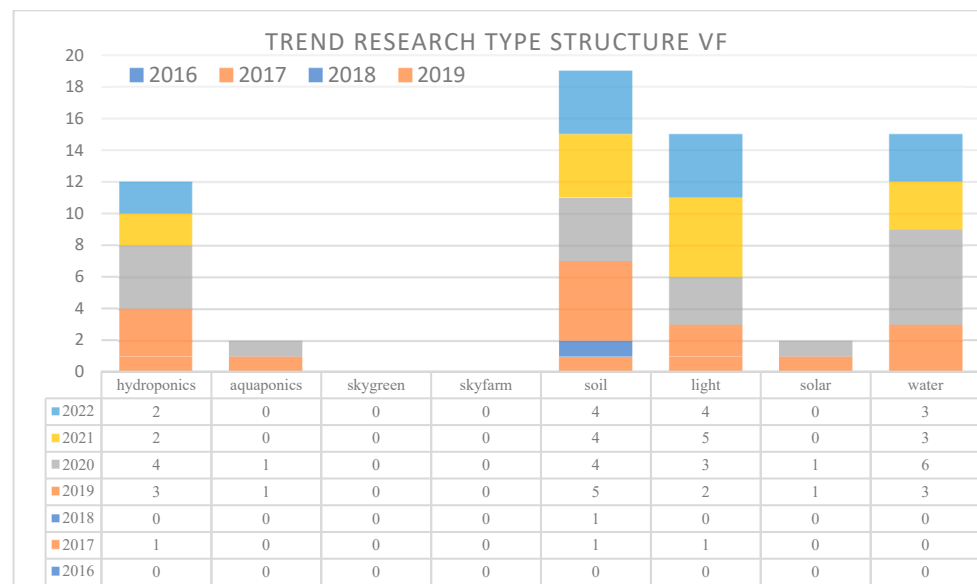

Figure 10. Trend-type structure distribution in vertical farms from 68 articles selected by year.

Table 4. IoT applications in vertical farming.

Area	Application	Approach Method	Reference
Hydroponics, Tomato plant growth	Developed using Arduino, Raspberry Pi3, and Tensor Flow.	Deep Neural Networks	[57]
Urban farming	NB-IoT sensor network (deployed in balconies of two multistory building structures)	Fuzzy logic	[58]
Urban farming decision support framework	DSS to online database captured by IoT technologies and robotic machines, it is promising to achieve a high level of automation in the field of urban agriculture	Decision support systems (DSS) based on modeling and simulation have been developed to assess farming systems	[59]
Plant Factory Artificial Light (PFAL) management system	Use of artificial intelligence (AI) with a database, Internet of Things (IoT), light-emitting diodes (LEDs), and phenotyping unit	AI-based smart PFAL management system	[60]
Plan Factory	Greenhouse environmental monitoring, develop complex mathematical models to minimize energy input or use solar or wind energy	Controlled environment agriculture (CEA)	[61]
Smart indoor farming—secure and self-adapting	The important element for such solutions is a cloud, IoT, and robotics-based smart farming framework.	AgroRobot and Indoor Farming Support as a Service (IFSaaS)	[62]
Real-Time Greenhouse Environmental Conditions	Determination of nutrients needed for plant growth, such as nitrogen (N), phosphorus (P), and potassium (K) in soil or water, is the key to vertical or closed crop cultivation with IoT	Clustering quantity using the K-means method and a prediction approach using the Self-Organizing Map (SOM) method to enhance the device capacity and real-time analytics	[63]

Table 4. Cont.

Area	Application	Approach Method	Reference
CPS/IoT Ecosystem: Indoor Vertical Farming System	A prototype is a service-oriented platform distributed over three scopes of operation: cloud, fog, sensor/actuator	Smart agricultural systems using CPS/IoT infrastructure and offering Infrastructure-as-a-Service (IaaS) and Experiment-as-a-Service (EaaS) for smart farming	[53]
Digital Twins for Vertical Farming	Design science research paradigm, aiming at the joint creation of physical and digital layers of IoT-enabled structures for vertical farming	A digital twin reference model for IoT-enabled structures of vertical farming	[64]
Automatic vertical hydroponic farming	The design and implementation of automated vertical hydro farming techniques with IoT platforms, and their analytics will be conducted using big data analytics	Automatic robotic system design and development	[65]
IoT-Enabled in Smart Vertical Farming	Application of IoT-Enabled Smart Agriculture in Vertical Farming	The web-based application can be used to analyze and monitor the light, temperature, humidity, and soil moisture of the vertical farming stacks	[22]
Review adoption of vertical gardens (VG) and/or vertical farms (VF)	Automating sustainable vertical gardening systems by using the IoT concept in smart cities toward smart living	Literature review	[66]
Indoor Vertical Farming	Build a system to monitor the soil moisture and control water content	Automatic a system, which consists of the Internet of Things [IoT]	[67]

3. Results and Discussion

Based on the review, the proposed framework maps primarily onto three entities consisting of a vertical land smart model, AI/machine learning, and IoT. The literature sources were obtained from 2016 to 2022 and an article processing approach was carried out using PRISMA based on the search keywords in Table 1, which obtained 68 limited articles indexed by Scopus in quartile 1 as many as 11, quartile 2 as many as seven, quartile 3 as many as 11, quartile 4 as many as six and no quartile 33 articles. The distribution of reputation-indexed scientific articles at the quartile level (Scopus), with details are as follows: Q1 16%, Q2 16%, Q3 10%, Q4 95 and No Q 49%. The trend of the number of research and publications continues to increase in the application of digitalization of vertical agriculture by utilizing artificial intelligence. A review from the year that the trend is always increasing, it can be seen in 2021 by 32%, which is described in Figures 3 and 4. A total of 91% of the selected articles discuss vertical agriculture as shown in Figures 5 and 6. The distribution of the use of artificial intelligence has been widely conducted and found; this is seen in 47% of usage on machine learning, 22% on robotic automation, and 13% with deep learning approaches. The IoT approach can be seen from the discussion of the sensor, monitoring, and LED applications which is shown in Figure 9, with a 28% soil research object model, 18% hydroponics, and 22% lighting and irrigation.

Vertical agriculture has great potential to meet the future food demand by strengthening the digital farming system to support precision in agriculture with technology and artificial intelligence. The prospects of vertical farming in smart agriculture involve the use of explainable artificial intelligence to monitor crop growth, forecast crop nutrition, evaluate plant health, and control pests and diseases. The described AI removes the traditional

paradigm concept of machine learning and allows for an understanding of the reasons behind certain decisions [68].

IoT integration in vertical farming is focused on optimization and automation technologies that seamlessly integrate knowledge, products, and services to achieve high productivity, quality, and profit. Not much research has been conducted and put forward regarding the incubation of the IoT concept in the vertical agriculture sector. The main findings of several studies are presented in Table 4.

Various technological problems and architectural problems have been addressed through the development of an IoT-based vertical farming smart system, but most of these systems are either in the conceptual stage or in prototype form at this time. Its main focus lies in farm management, irrigation control, crop growth, crop health monitoring, and disease detection. Some of these studies have also explained the implementation of IoT in modern agricultural systems such as vertical farming (soilless farming—aquaponics, hydroponics, and aeroponics) and greenhouse farming (soil-based). In addition, most research focuses on addressing specific problems.

Artificial intelligence approaches and digital technologies in vertical farming make agricultural processes more environmentally friendly, and climate-resistant, significantly reducing crop failure and field growth, and also reducing the usage of nitrogen fertilizers, pesticides, and herbicides [35]. Based on the findings summarized in the previous section, machine learning algorithms and IoT smart technologies can be used to increase the overall efficiency of a vertical agricultural production system. However, in the review, the types of algorithms discussed in Table 3 have not been mentioned much in vertical farming; in this case, models on machine learning or deep learning. The analysis shows that several studies have focused on vertical farming.

The research findings also show that most of the use cases are still in the prototype stage. This is due to the complex design and management of indoor farming, especially soilless agriculture where the parameters and factors (pH, air temperature, humidity, etc.) to be controlled vary [69] considerably. By looking at Tables 3 and 4 in Section 3, it can be seen that some of the uses of artificial intelligence algorithms from machine learning and deep learning as well as technologies such as big data and analytics, wireless sensor networks, cyber-physical systems, and digital twins in the field of vertical farming have not been significantly explored. In addition, the costs required to develop smart models for vertical farming are still expensive, which include deployment, operation, and maintenance costs [70].

The reliability of the sensor devices, as well as the appropriate software applications are very important. This is because IoT devices need to collect and transfer data based on decisions made using multiple software packages. Unreliable sensing, processing, and transmission can lead to erroneous monitoring data reports, long delays, and even data loss, thus ultimately impacting agricultural system performance [71]. Standardization is needed to take full advantage of digital technology for smart vertical farming applications, particularly in device standardization. With standardization, device, application, and system interoperability problems can also be solved. The results of previous research on vertical farming applications have been developed to manage various vertical farming services. Most of the study systems are still classified as prototype and conceptual. Then, a lot of research was conducted on greenhouses, and no investigation was found that is relevant to the farming system that has been applied. There are still new research opportunities to investigate and study indoor food crop production using smart and precision vertical farming.

4. Conclusions

The results of this study contribute to research that will be carried out around vertical agriculture to support Agriculture 4.0. Vertical farming with AI, ML, and DL approaches has been carried out in several previous studies. The main limitation of this review is that it uses only the prioritized online repositories for literature searches (Scopus, IEEE, and

Science Direct). Second, additional keywords and synonyms can result in more research. SLR implementation with PRISMA received 68 articles from 2016 to 2022 discussing the problems and recommendations for vertical farming presented in this study. The pattern in the vertical agriculture sector is continually increasing. The results can be selected in 2021 by 32%, as depicted in Figures 3 and 4. A total of 91% of articles were chosen to discuss vertical agriculture, as shown in Figures 5 and 6. The distribution of the use of artificial intelligence has been completed and discovered. This is seen in 47% of usage on machine learning, 22% on robotic automation, and 13% on deep learning approaches. The IoT approach can be seen from the discussion of the sensor, monitoring, and LED applications shown in Figure 9, with a 28% soil research object model, 18% hydroponics, and 22% lighting and irrigation. The research questions posed are regarding the types of digital technologies used in vertical farming of innovative farming relationships, the level of development and intelligent models adopted, and the challenges and barriers to gaining opportunities from implementing intelligent vertical farming systems. The added value of vertical agriculture has various advantages compared to horizontal rice fields, as seen from the three pillars of sustainability; namely environmental, social, and economic, in the effort of world food security. The results of studies from previous research on IoT applications in vertical farms have been developed to manage various services on vertical farms. Most of the systems are still classified as prototypes and mainly carried out conceptually for greenhouses. No relevant research on basic crop farming systems such as rice, soybean, or wheat has been implemented. With the results shown from the number of articles reviewed, the use of artificial intelligence algorithms from machine learning and deep learning as well as technologies such as big data and analytics, wireless sensor networks, cyber-physical systems, and digital twins have not been significant and explored in vertical farming. This is because the costs required to develop an intelligent vertical farming model are still expensive, including implementation, operational, and maintenance costs. This research reveals that there are new research opportunities to investigate and study indoor food crop production using smart and precision vertical farming.

Author Contributions: Conceptualization, K.B.S. and R.R.A.S.; methodology, K.B.S. and R.R.A.S.; software, R.R.A.S.; validation, K.B.S., S.W. and E.S.; formal analysis, K.B.S., S.W. and E.S.; investigation, E.S. and S.W.; resources, R.R.A.S.; data curation, R.R.A.S.; writing—original draft preparation, R.R.A.S. and K.B.S.; writing—review and editing, R.R.A.S. and K.B.S.; visualization, S.W.; supervision, K.B.S.; project administration, K.B.S. All authors have read and agreed to the published version of the manuscript.

Funding: This research received no external funding.

Institutional Review Board Statement: Not applicable.

Informed Consent Statement: Not applicable.

Data Availability Statement: The study did not report any data.

Conflicts of Interest: The authors declare no conflict of interest.

References

1. United Nations News Service. "UN News—UN Projects World Population to Reach 8.5 Billion by 2030, Driven by Growth in Developing Countries" UN News. 2015. Available online: <http://www.un.org/apps/news/story.asp?NewsID=51526#.VkcOinYrLIW> (accessed on 23 June 2021).
2. Alfred, R.; Obit, J.H.; Chin, C.P.-Y.; Haviluddin, H.; Lim, Y. Towards Paddy Rice Smart Farming: A Review on Big Data, Machine Learning, and Rice Production Tasks. *IEEE Access* **2021**, *9*, 50358–50380. [[CrossRef](#)]
3. Baumont De Oliveira, F.J.; Ferson, S.; Dyer, R. A Collaborative Decision Support System Framework for Vertical Farming Business Developments. *Int. J. Decis. Support Syst. Technol.* **2021**, *13*, 34–66. [[CrossRef](#)]
4. Ahmad, L.; Nabi, F. *Agriculture 5.0: Artificial Intelligence, IoT, and Machine Learning*, 1st ed.; CRC Press: Boca Raton, FL, USA; Taylor & Francis Group, LLC: Abingdon, UK, 2021; ISBN 9780367646080.
5. Chen, J.; Yang, A. Intelligent Agriculture and Its Key Technologies Based on Internet of Things Architecture. *IEEE Access* **2019**, *7*, 77134–77141. [[CrossRef](#)]

6. Tzounis, A.; Katsoulas, N.; Bartzanas, T.; Kittas, C. Internet of Things in agriculture, recent advances and future challenges. *Biosyst. Eng.* **2017**, *164*, 31–48. [[CrossRef](#)]
7. Kalantari, F.; Tahir, O.M.; Joni, R.A.; Fatemi, E. Opportunities and challenges in sustainability of vertical farming: A review. *J. Landsc. Ecol. Repub.* **2018**, *11*, 35–60. [[CrossRef](#)]
8. Despommier, D. The rise of vertical farms. *Sci. Am.* **2009**, *301*, 80–87. [[CrossRef](#)] [[PubMed](#)]
9. Lu, C.; Grundy, S. *Urban Agriculture and Vertical Farming*; Elsevier: Amsterdam, The Netherlands, 2017; Volume 2, ISBN 9780128046777.
10. Sharath Kumar, M.; Heuvelink, E.; Marcelis, L.F.M. Vertical Farming: Moving from Genetic to Environmental Modification. *Trends Plant Sci.* **2020**, *25*, 724–727. [[CrossRef](#)] [[PubMed](#)]
11. Ismail, M.A.F.; Isa, M.N.M.; Mohyar, S.N.; Ahmad, M.I.; Ismail, M.N.M.; Ismail, R.C.; Harun, A.; Murad, S.A.Z. E-PADI: An IoT-based paddy productivity monitoring and advisory system. *Indones. J. Electr. Eng. Comput. Sci.* **2019**, *14*, 852–858. [[CrossRef](#)]
12. Villa-Henriksen, A.; Edwards, G.T.C.; Pesonen, L.A.; Green, O.; Sørensen, C.A.G. Internet of Things in arable farming: Implementation, applications, challenges and potential. *Biosyst. Eng.* **2020**, *191*, 60–84. [[CrossRef](#)]
13. Jaiswal, H.; Karmali Radha, P.; Singuluri, R.; Sampson, S.A. IoT and Machine Learning based approach for Fully Automated Greenhouse. In Proceedings of the 2019 IEEE Bombay Section Signature Conference, Bombay, India, 26–28 July 2019. [[CrossRef](#)]
14. Gnanasankaran, N.; Ramaraj, E. The effective yield of paddy crop in Sivaganga district—An initiative for smart farming. *Int. J. Sci. Technol. Res.* **2020**, *9*, 6452–6455.
15. Liakos, K.G.; Busato, P.; Moshou, D.; Pearson, S.; Bochtis, D. Machine learning in agriculture: A review. *Sensors* **2018**, *18*, 2674. [[CrossRef](#)] [[PubMed](#)]
16. Tur, J.A.; Bibiloni, M.M. *Functional Foods*, 1st ed.; Elsevier: Amsterdam, The Netherlands, 2015; ISBN 9780123849533.
17. Al-Kodmany, K. The vertical farm: A review of developments and implications for the vertical city. *Buildings* **2018**, *8*, 24. [[CrossRef](#)]
18. Jayaraman, P.P.; Yavari, A.; Georgakopoulos, D.; Morshed, A.; Zaslavsky, A. Internet of things platform for smart farming: Experiences and lessons learnt. *Sensors* **2016**, *16*, 1884. [[CrossRef](#)] [[PubMed](#)]
19. Bianchi, V.; Bassoli, M.; Lombardo, G.; Fornacciari, P.; Mordonini, M.; de Munari, I. IoT Wearable Sensor and Deep Learning: An Integrated Approach for Personalized Human Activity Recognition in a Smart Home Environment. *IEEE Internet Things J.* **2019**, *6*, 8553–8562. [[CrossRef](#)]
20. Bu, F.; Wang, X. A smart agriculture IoT system based on deep reinforcement learning. *Futur. Gener. Comput. Syst.* **2019**, *99*, 500–507. [[CrossRef](#)]
21. Bi, S.; Wang, C.; Zhang, J.; Huang, W.; Wu, B.; Gong, Y.; Ni, W. A Survey on Artificial Intelligence Aided Internet-of-Things Technologies in Emerging Smart Libraries. *Sensors* **2022**, *22*, 2991. [[CrossRef](#)]
22. Bhowmick, S.; Biswas, B.; Biswas, M.; Dey, A.; Roy, S.; Sarkar, S.K. Application of IoT-Enabled Smart Agriculture in Vertical Farming. *Lect. Notes Electr. Eng.* **2019**, *537*, 521–528. [[CrossRef](#)]
23. Swain, M. Vertical Farming Trends and Challenges: A New Age of Agriculture Using IoT and Machine Learning. In *Internet of Things for Agriculture 4.0: Impact and Challenges*; Apple Academic Press: Boca Raton, FL, USA, 2022; pp. 1–16. ISBN 9781000369274.
24. Schimmelpfennig, D. *Farm Profits and Adoption of Precision Agriculture*. [*Economic Research Report: #217*]; United States Department of Agriculture: Washington, DC, USA, 2016.
25. Saiz-Rubio, V.; Rovira-Más, F. From smart farming towards agriculture 5.0: A review on crop data management. *Agronomy* **2020**, *10*, 207. [[CrossRef](#)]
26. CEMA. “CEMA—European Agricultural Machinery—Priorities,” CEMA aisbl—European Agricultural Machinery Industry Association. 2021. Available online: https://www.cema-agri.org/index.php?option=com_content&view=priorities&id=8&Itemid=102 (accessed on 2 April 2021).
27. Agriculture IoT Solutions. What Is IoT in Agriculture? Farmers Aren’t Quite Sure Despite \$4bn US Opportunity, Agfunder. 2018. Available online: <https://agfundernews.com/iot-agriculture-farmers-arent-quite-sure-despite-4bn-us-opportunity.html/> (accessed on 2 April 2021).
28. Gralla, P. Precision Agriculture Yields Higher Profits, Lower Risks | HPE,” Hewlett Packard Enterprise Development LP. 2018. Available online: <https://www.hpe.com/us/en/insights/articles/precision-agriculture-yields-higher-profits-lower-risks-1806.html> (accessed on 2 April 2021).
29. Dhivyaa, C.R.; Anbukkarasi, S.; Saravanan, K. Machine Learning Approaches for Agro IoT Systems. *Stud. Big Data* **2021**, *99*, 93–111. [[CrossRef](#)]
30. Ogawa, S.; Selvaraj, M.G.; Ishitani, M. Crop Development with Data-driven Approach towards Sustainable Agriculture: Lifting the Achievements and Opportunities of Collaborative Research between CIAT and Japan. *Japan Agric. Res. Q.* **2021**, *55*, 463–472. [[CrossRef](#)]
31. Page, M.J.; McKenzie, J.E.; Bossuyt, P.M.; Boutron, I.; Hoffmann, T.C.; Mulrow, C.D.; Shamseer, L.; Tetzlaff, J.M.; Akl, E.A.; Brennan, S.E.; et al. The PRISMA 2020 statement: An updated guideline for reporting systematic reviews. *BMJ* **2021**, *372*, n71. [[CrossRef](#)] [[PubMed](#)]
32. Abbasi, R.; Martinez, P.; Ahmad, R. The digitization of agricultural industry—A systematic literature review on agriculture 4.0. *Smart Agric. Technol.* **2022**, *2*, 100042. [[CrossRef](#)]

33. Popkova, E.G. Vertical Farms Based on Hydroponics, Deep Learning, and AI as Smart Innovation in Agriculture. *Smart Innov. Syst. Technol.* **2022**, *264*, 257–262. [[CrossRef](#)]
34. Ng, A.K.; Mahkeswaran, R. Emerging and Disruptive Technologies for Urban Farming: A Review and Assessment. *J. Phys. Conf. Ser.* **2021**, *2003*, 012008. [[CrossRef](#)]
35. Krishnan, A.; Swarna, S.; Balasubramanya, H.S. Robotics, IoT, and AI in the Automation of Agricultural Industry: A Review. In Proceedings of the 2020 IEEE Bangalore Humanitarian Technology Conference (B-HTC), Vijiyapur, India, 8–10 October 2020. [[CrossRef](#)]
36. Abukhader, R.; Kakoore, S. *Artificial Intelligence For Vertical Farming—Controlling The Food*; Mälardalen University School of Innovation, Design And Engineering: Västerås, Sweden, 2021.
37. Saad, M.H.M.; Hamdan, N.M.; Sarker, M.R. State of the art of urban smart vertical farming automation system: Advanced topologies, issues and recommendations. *Electronics* **2021**, *10*, 422. [[CrossRef](#)]
38. Sharma, R.; Kamble, S.S.; Gunasekaran, A.; Kumar, V.; Kumar, A. A systematic literature review on machine learning applications for sustainable agriculture supply chain performance. *Comput. Oper. Res.* **2020**, *119*. [[CrossRef](#)]
39. Talaviya, T.; Shah, D.; Patel, N.; Yagnik, H.; Shah, M. Implementation of artificial intelligence in agriculture for optimisation of irrigation and application of pesticides and herbicides. *Artif. Intell. Agric.* **2020**, *4*, 58–73. [[CrossRef](#)]
40. Rohit, R.V.S.; Chandrawat, D.; Rajeswari, D. Smart Farming Techniques for New Farmers Using Machine Learning. *Lect. Notes Netw. Syst.* **2021**, *177*, 207–220. [[CrossRef](#)]
41. Naranjani, B.; Najafianashrafi, Z.; Pascual, C.; Agulto, I.; Chuang, P.Y.A. Computational analysis of the environment in an indoor vertical farming system. *Int. J. Heat Mass Transf.* **2022**, *186*, 122460. [[CrossRef](#)]
42. Tolga, A.C.; Gamsiz, B.; Basar, M. Evaluation of hydroponic system in vertical farming via fuzzy EDAS method. *Adv. Intell. Syst. Comput.* **2020**, *1029*, 745–752. [[CrossRef](#)]
43. Cagri Tolga, A.; Basar, M. The assessment of a smart system in hydroponic vertical farming via fuzzy MCDM methods. *J. Intell. Fuzzy Syst.* **2022**, *42*, 2–12. [[CrossRef](#)]
44. Santini, A.; Bartolini, E.; Schneider, M.; Greco de Lemos, V. The crop growth planning problem in vertical farming. *Eur. J. Oper. Res.* **2021**, *294*, 377–390. [[CrossRef](#)]
45. Delorme, M.; Santini, A. Energy-efficient automated vertical farms. *Omega* **2022**, *109*, 102611. [[CrossRef](#)]
46. Sadik Tasrif Anubhove, M.; Ashrafi, N.; Saleque, A.M.; Akter, M.; Saif, S.U. Machine Learning Algorithm based Disease Detection in Tomato with Automated Image Telemetry for Vertical Farming. In Proceedings of the 2020 International Conference on Computational Performance Evaluation (ComPE), Shillong, India, 2–4 July 2020; pp. 250–254. [[CrossRef](#)]
47. Büyüközkan, G.; Göçer, F.; Uztürk, D. *A Novel Pythagorean Fuzzy Set Integrated Choquet Integral Approach for Vertical Farming Technology Assessment*; Elsevier: Amsterdam, The Netherlands, 2021; Volume 158.
48. Labrador, C.G.; Ong, A.C.L.; Baldovino, R.G.; Valenzuela, I.C.; Culaba, A.B.; Dadios, E.P. Optimization of power generation and distribution for vertical farming with wireless sensor network. In Proceedings of the 2018 IEEE 10th International Conference on Humanoid, Nanotechnology, Information Technology, Communication and Control, Environment and Management (HNICEM), Baguio City, Philippines, 29 November–2 December 2018. [[CrossRef](#)]
49. Chen, Q.; Li, L.; Chong, C.; Wang, X. AI-enhanced soil management and smart farming. *Soil Use Manag.* **2022**, *38*, 7–13. [[CrossRef](#)]
50. Wickramaarachchi, P.; Balasooriya, N.; Welipenne, L.; Gunasekara, S.; Jayakody, A. Real-time greenhouse environmental conditions optimization using neural network and image processing. In Proceedings of the 2020 20th International Conference on Advances in ICT for Emerging Regions (ICTer), Colombo, Sri Lanka, 4–7 November 2020; pp. 232–237. [[CrossRef](#)]
51. Franchetti, B.; Ntouskos, V.; Giuliani, P.; Herman, T.; Barnes, L.; Pirri, F. Vision based modeling of plants phenotyping in vertical farming under artificial lighting. *Sensors* **2019**, *19*, 4378. [[CrossRef](#)] [[PubMed](#)]
52. Pylaniadis, C.; Osinga, S.; Athanasiadis, I.N. Introducing digital twins to agriculture. *Comput. Electron. Agric.* **2021**, *184*, 105942. [[CrossRef](#)]
53. Haris, I.; Fasching, A.; Punzenberger, L.; Grosu, R. CPS/IoT Ecosystem: Indoor Vertical Farming System. In Proceedings of the 2019 IEEE 23rd International Symposium on Consumer Technologies (ISCT), Ancona, Italy, 19–21 June 2019; pp. 47–52. [[CrossRef](#)]
54. Jimenez, A.F.; Cardenas, P.F.; Jimenez, F.; Canales, A.; López, A. A cyber-physical intelligent agent for irrigation scheduling in horticultural crops. *Comput. Electron. Agric.* **2020**, *178*, 105777. [[CrossRef](#)]
55. Jawad, H.M.; Nordin, R.; Gharghan, S.K.; Jawad, A.M.; Ismail, M. Energy-efficient wireless sensor networks for precision agriculture: A review. *Sensors* **2017**, *17*, 1781. [[CrossRef](#)]
56. Nayak, A.; Reyes Levalle, R.; Lee, S.; Nof, S.Y. Resource sharing in cyber-physical systems: Modelling framework and case studies. *Int. J. Prod. Res.* **2016**, *54*, 6969–6983. [[CrossRef](#)]
57. Mehra, M.; Saxena, S.; Sankaranarayanan, S.; Tom, R.J.; Veeramanikandan, M. IoT based hydroponics system using Deep Neural Networks. *Comput. Electron. Agric.* **2018**, *155*, 473–486. [[CrossRef](#)]
58. Popli, S.; Jha, R.K.; Jain, S. Green NOMA assisted NB-IoT based urban farming in multistory buildings. *Comput. Netw.* **2021**, *199*, 108410. [[CrossRef](#)]
59. Li, L.; Li, X.; Chong, C.; Wang, C.H.; Wang, X. A decision support framework for the design and operation of sustainable urban farming systems. *J. Clean. Prod.* **2020**, *268*, 121928. [[CrossRef](#)]
60. Kozai, T. Current Status of Plant Factories with Artificial Lighting (PFALs) and Smart PFALs. *Smart Plant Fact.* **2018**, 3–13. [[CrossRef](#)]

61. Shamshiri, R.R.; Kalantari, F.; Ting, K.C.; Thorp, K.R.; Hameed, I.A.; Weltzien, C.; Ahmad, D.; Shad, Z. Advances in greenhouse automation and controlled environment agriculture: A transition to plant factories and urban agriculture. *Int. J. Agric. Biol. Eng.* **2018**, *11*, 1–22. [[CrossRef](#)]
62. Gnauer, C.; Pichler, H.; Tauber, M.; Schmittner, C.; Christl, K.; Knapitsch, J.; Parapatits, M. Towards a secure and self-adapting smart indoor farming framework. *Elektrotechnik Inf.* **2019**, *136*, 341–344. [[CrossRef](#)]
63. Vadivel, R.; Parthasarathi, R.; Navaneethraj, A.; Sridhar, P.; Muhammad Nafi, K.A.; Karan, S. Hypaponics-Monitoring and Controlling using Internet of Things and Machine Learning. In Proceedings of the 2019 1st International Conference on Innovations in Information and Communication Technology (ICIICT), Chennai, India, 25–26 April 2019. [[CrossRef](#)]
64. Monteiro, J.; Barata, J.; Veloso, M.; Veloso, L.; Nunes, J. Towards sustainable digital twins for vertical farming. In Proceedings of the 2018 Thirteenth International Conference on Digital Information Management (ICDIM), Berlin, Germany, 24–26 September 2018; pp. 234–239. [[CrossRef](#)]
65. Shrivastava, A.; Nayak, C.K.; Dilip, R.; Samal, S.R.; Rout, S.; Ashfaq, S.M. Automatic robotic system design and development for vertical hydroponic farming using IoT and big data analysis. *Mater. Today Proc.* **2021**. [[CrossRef](#)]
66. Halgamuge, M.N.; Bojovschi, A.; Fisher, P.M.J.; Le, T.C.; Adeloju, S.; Murphy, S. Internet of Things and autonomous control for vertical cultivation walls towards smart food growing: A review. *Urban For. Urban Green.* **2021**, *61*, 127094. [[CrossRef](#)]
67. Bin Ismail, M.I.H.; Thamrin, N.M. IoT implementation for indoor vertical farming watering system. In Proceedings of the 2017 International Conference on Electrical, Electronics and System Engineering (ICEESE), Kanazawa, Japan, 9–10 November 2017; pp. 89–94. [[CrossRef](#)]
68. Araújo, S.O.; Peres, R.S.; Barata, J.; Lidon, F.; Ramalho, J.C. Characterising the agriculture 4.0 landscape—emerging trends, challenges and opportunities. *Agronomy* **2021**, *11*, 667. [[CrossRef](#)]
69. Abbasi, R.; Martinez, P.; Ahmad, R. An ontology model to represent aquaponics 4.0 system’s knowledge. *Inf. Process. Agric.* **2022**; *in press*. [[CrossRef](#)]
70. Sinha, B.B.; Dhanalakshmi, R. Recent advancements and challenges of Internet of Things in smart agriculture: A survey. *Future Gener. Comput. Syst.* **2022**, *126*, 169–184. [[CrossRef](#)]
71. Kour, V.P.; Arora, S. Recent Developments of the Internet of Things in Agriculture: A Survey. *IEEE Access* **2020**, *8*, 129924–129957. [[CrossRef](#)]