

Article

3D Concrete Printing Sustainability: A Comparative Life Cycle Assessment of Four Construction Method Scenarios

Malek Mohammad ^{1,2}, Eyad Masad ² and Sami G. Al-Ghamdi ^{1,*} 

¹ Division of Sustainable Development, College of Science and Engineering, Hamad Bin Khalifa University, Qatar Foundation, Doha 34110, Qatar; mmohammad@hbku.edu.qa

² Mechanical Engineering Program, Texas A&M University at Qatar, Doha 23874, Qatar; eyad.masad@qatar.tamu.edu

* Correspondence: salghamdi@hbku.edu.qa

Received: 1 November 2020; Accepted: 9 December 2020; Published: 17 December 2020



Abstract: Three-dimensional concrete printing (3DCP) has become recognized as a possible alternative to conventional concrete construction, mainly due to its potential to increase productivity and reduce the environmental impact of the construction industry. Despite its up-and-coming popularity within the field, limited research has quantitatively investigated the environmental benefits that 3DCP brings. This paper investigates the environmental tradeoff of utilizing 3DCP over conventional construction by conducting a detailed cradle-to-gate life cycle assessment (LCA) study of four case-scenarios (conventional concrete construction, 3DCP with reinforcement elements, 3DCP without any reinforcement, and 3DCP without any reinforcement and utilizing a lightweight printable concrete material.) These case-scenarios were carefully selected to quantify the environmental impact of 3DCP while emphasizing the importance of the material composition. The LCA was conducted for a 1 m² external load-bearing wall in all four scenarios. The LCA analysis showed that 3DCP significantly reduced environmental effects in terms of global warming potential (GWP), acidification potential (AP), eutrophication potential (EP), smog formation potential (SFP), and fossil fuel depletion (FFD), as compared to conventional construction methods. However, these environmental improvements diminished when 3DCP was coupled with the use of conventional reinforcement elements. Moreover, the use of an alternative concrete mixture in 3DCP showed a further decrease in the GWP, AP, EP, and FFD impact. Ultimately, the findings in this paper support the advantages of 3DCP technology and recommend the investigation of the development of (i) sustainable printable concrete materials and (ii) novel reinforcement techniques that are suitable for 3DCP rather than adopting conventional reinforcement techniques.

Keywords: 3D concrete printing; life cycle assessment; environmental impact; sustainable construction

1. Introduction

The environmental impact of the construction and operation of the built environment is immense. The construction industry accounts for 40% of global energy consumption, 28% of global greenhouse gas (GHG) emissions, 12% of global potable water usage, and 40% of developed countries' solid waste generation [1]. Concrete and cement-based materials are at the core of the construction industry, having increased 34 times in the last 65 years despite the human population increasing by only three times [2,3]. Although the use of concrete material continues to increase, several adverse environmental effects of its production and use in the construction sector have become evident in recent years. Concrete production has a large carbon footprint, accounting for 4–5% of worldwide emission of CO₂ [4]. In addition, a significant amount of waste is generated in the construction process, primarily from formwork wastage

used to create temporary molds for pouring and forming concrete [5]. Apart from the environmental concerns, the concrete construction sector is a labor- and capital-intensive industry, requiring high costs for material usage, equipment, and labor [6].

In recent years, there has been a growing interest in the automation of concrete construction using 3D-printing technology. Automation has been growing in popularity in many industries to increase production efficiency. Three-dimensional concrete printing (3DCP) is a computer-aided process that builds concrete structures by extruding concrete layer by layer through a digitally controlled nozzle. The adoption of 3D printing in the construction sector was accelerated through the development of a process known as contour crafting [7,8]. This novel method facilitated 3D concrete printing of large building structures by extruding concrete paste by using larger nozzles and higher pressure to account for the different consistencies of concrete. The appropriate automation of the construction sector through 3DCP has many benefits, including decreased costs, time, and labor, while increasing productivity and improving the quality of construction. In addition, 3DCP eliminates the geometric constraint of structures put forth by conventional concrete building, thus allowing for the highly precise fabrication of complex, geometric, and hollow structures.

To assess the full environmental impact of a structure, all phases of the building process must be properly evaluated, beginning prior to construction and continuing through demolition and the analysis of the materials' possibilities for reuse. Life cycle assessment (LCA) is a method that assesses the environmental impact of a product over its service lifetime. LCA tools were initially developed to support decision makers in distinguishing between products, product systems, and services on the basis of their environmental performances [9]. In terms of construction, LCA quantifies the environmental impact of a built structure over its lifetime and has been used intensively in the literature and in practice [10–14]. Many studies have highlighted the potential for 3DCP to influence the energy and environmental footprint of concrete buildings [15–18]. In addition, many authors' [19–23] LCA comparisons of conventional manufacturing versus additive manufacturing have indicated that additive manufacturing decreases overall environmental impact and increases the possibility of recycling. In particular, one study showed that a prefabricated bathroom unit constructed by using 3DCP achieved an overall 25.4% reduction in cost, an 85.9% decrease in CO₂ emission, and an 87.1% decrease in energy consumption from the same unit built by using the precast method [6]. Another study compared the environmental impact of constructing a section of a 1 m² load-bearing wall by using two methods: the conventional concrete method and 3DCP [24]. The study found that 3DCP outperformed the conventional construction method in almost all environmental impact categories. One reason for this is that 3DCP does not require formwork or reinforced steel, thus significantly increasing its environmental friendliness. However, 3DCP does require more cement and fly ash in the printable concrete mixture so that the printed structure can hold its shape. This increase, in turn, adds to 3DCP's contribution to global warming and is indeed collectively responsible for 70.8% of the environmental impact of the method [24]. Because cement-based material has been shown to dominate the environmental impact categories of 3DCP LCA studies, research in the development of a high-quality and environmentally friendly cement-based material has gained popularity. Once such material incorporates microcrystalline cellulose (MCC), which has been suggested as a potential reinforcement for cement-based composites [25], the study found that the partial replacement of the binder with MCC decreased the overall GHG emissions. This shows that, with the appropriate cement-based material, 3DCP can further reduce the environmental impact at the construction stage.

Another attractive feature of 3DCP is its contribution to effectiveness and productivity. Compared to conventional concrete construction, 3DCP allows for the construction of complex structures with little to no formwork. In addition, 3DCP facilitates the construction of structures with complex geometries with little to no additional expenses [26–29].

Moreover, 3DCP brings significant benefits in terms of environmental impact, cost, waste, and labor reduction, and that it substantially increases the geometric freedom of built structures. Most of the full-scale 3DCP projects incorporate reinforced concrete columns and beams within the printed structure to satisfy building codes and standards; however, these structural elements have been designed for use with conventional concrete construction. The literature lacks the investigation of whether the addition of conventional reinforcement within the context of 3DCP may contradict the environmental friendliness of the technology. Likewise, the literature lacks the investigation of whether or not there is a structural need for reinforcement in 3D-printed structures or whether 3DCP may adopt alternative forms of reinforcement. Additionally, the environmental impact when more sustainable printable concrete is integrated with 3DCP (as means to further decrease environmental impact of construction) is yet to be assessed. To this end, the objectives of this paper are as follows:

- a Investigate the environmental tradeoff gained when utilizing 3DCP over conventional construction;
- b Investigate the environmental impact of incorporating reinforced columns and beams within a 3D-printed structure versus their omission;
- c Investigate the environmental impact of 3DCP when an alternative concrete mixture is adopted.

To address the aforementioned objects, a detailed LCA is conducted on four scenarios:

- Scenario 1 (S-1): Conventional construction method using concrete masonry block with reinforced concrete columns and beam.
- Scenario 2 (S-2): 3DCP construction method with reinforced concrete columns and beams.
- Scenario 3 (S-3): 3DCP construction method without reinforced concrete columns and beams.
- Scenario 4 (S-4): 3DCP construction method using an alternative concrete mixture and without reinforced concrete columns and beams.

Scenario 1 quantifies the environmental impact of conventional wall construction. Scenarios 2 and 3 evaluate the environmental impact of 3DCP when reinforced concrete columns and beams are included within the printed structure and when they are omitted, respectively. Scenario 4 aims to evaluate the impact of coupling more sustainable concrete material with 3DCP. The results of the LCA are evaluated and compared, to assess the environmental impact of each construction method, as well as how the construction material impacts the environment. The environmental impact categories studied in this work include global warming potential (GWP), acidification potential (AP), eutrophication potential (EP), smog formation potential (SFP), and fossil fuel depletion (FFD). The results of this paper provide significant contribution in a relatively new and understudied field and provide compelling evidence on the importance of the adoption of 3DCP technology with more sustainable printable concrete. In addition, the findings of this paper motivates research direction in assessing whether 3DCP needs reinforcement and developing reinforcement strategies specific for 3DCP.

2. Materials and Methods

The selected method for evaluation in this case study is the standardized process LCA framework presented in the International Organization for Standards (ISO 14040) [9]. This LCA method is selected because it is specifically designed to assess the environmental impact of products and processes throughout their all life cycle stages (material extraction, manufacturing, distribution, use, and final disposal). Other methods, such as the environmental impact assessment (EIA), are more suitable for the evaluation of the environmental and economic impact of policies, plans, or projects and look at the environmental impact of the overall project, which is not ideal for the objectives of this work [30,31]. This section discusses the methodology adopted to implement the LCA, including the goal and scope, system boundaries, the function unit selected to evaluate the four scenarios, environmental impact categories studied, and the construction material and energy consumption of all four scenarios.

2.1. Goal and Scope

The goal of this study is twofold. The first goal is to determine whether and to what extent environmental benefits can be achieved through 3DCP versus the conventional construction method. The second goal is to assess and compare the environmental impact of 3DCP under three scenarios, namely 3DCP with reinforcement, 3DCP without reinforcement, and 3DCP without reinforcement and using a lightweight concrete alternative. To study the environmental impact of all four construction methods, a functional unit was chosen to represent a 1 m² section of an external load-bearing wall with a 20 cm thickness. The functional units were carefully chosen to be representative of the main function of the system being studied and to allow for a fair and meaningful comparison between the different material and construction processes. The functional units of the 3DCP method and the conventional construction method differ to reflect the differences in the physical and structural properties unique to each; however, the constructed units satisfy and serve the same structural function and purpose. In particular, the analysis of S-1 and S-2 utilizes a 4 × 3 m² wall in order to incorporate the structural elements (reinforced concrete columns and beam) for a structural-size wall; consequently, the calculated quantities in the 4 × 3 m² wall are downscaled by dividing by 12 to represent the quantities in a 1 m² unit and for meaningful comparison with S-3 and S-4. Table 1 outlines the four studied scenarios and their respective details.

Table 1. Description of the four studied construction scenarios.

	S-1	S-2	S-3	S-4
Description	Conventional construction method	3DCP method with reinforced concrete structural system	3DCP method without reinforced concrete structural system using high-performance concrete	3DCP method without reinforced concrete structural system using lightweight concrete
Columns and beam	2 columns 60 × 20 cm and beam 40 × 20 cm	2 columns 60 × 20 cm and beam 40 × 20 cm	N/A	N/A
Material	Concrete Steel reinforcement Formwork CMU Mortar	Concrete Steel reinforcement Formwork 3DCP high-performance concrete	3DCP high-performance concrete	3DCP lightweight concrete

S-1, Scenario 1; S-2, Scenario 2; S-3, Scenario 3; S-4, Scenario 4; 3DCP, three-dimensional concrete printing; CMU, concrete masonry unit.

A cradle-to-gate LCA was performed that includes raw material extraction, material production, and product construction for the four constructed walls. This paper studies the environmental impact of four forms of construction materials and processes independent of the place of building and thus, the environmental effects of material transportation are beyond the system boundaries and scope of the work [25]. Figure 1 illustrates the general system boundaries of the proposed study, which include the production (extraction of raw material and its production into construction material) and construction phases only. The LCA modeling was conducted in GaBi 9.2.1.68, by Thinkstep, using the GaBi 2020 database in accordance with GaBi databases and modeling principles. The entire embodied impact of the processed raw material was obtained from the GaBi database (see Supplementary Materials).

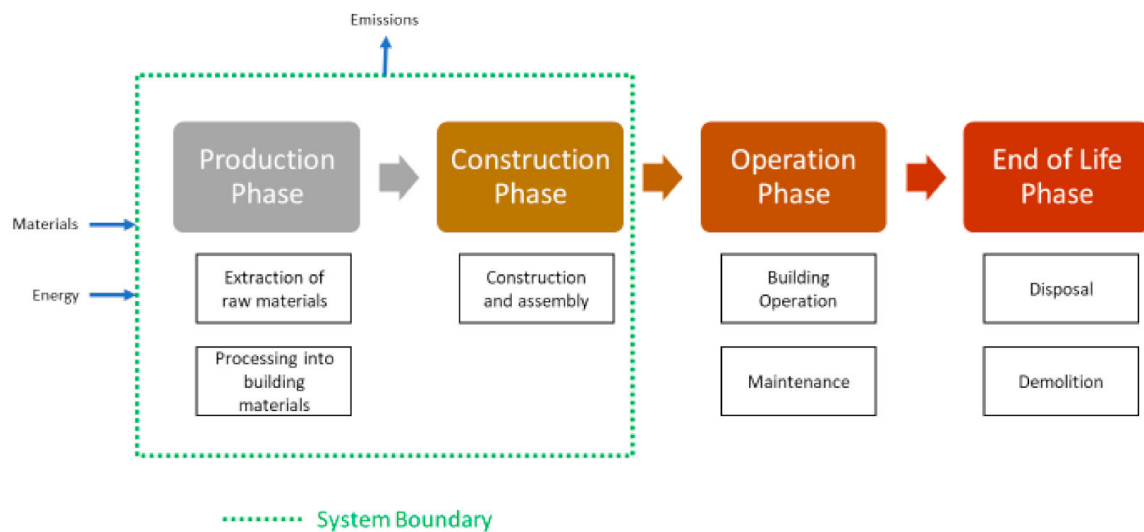

Figure 1. System boundaries of the proposed study.

2.2. Material and Data Inventory

2.2.1. Scenario 1

The functional unit for S-1 combines three components: columns, beam, and blocks, as shown in Figure 2. The wall is made of a hollow concrete masonry unit (CMU) with the dimensions $200 \times 200 \times 400 \text{ mm}^3$, two reinforced concrete columns of $600 \times 200 \text{ mm}^2$, and a reinforced concrete beam of $400 \times 200 \text{ mm}^2$.

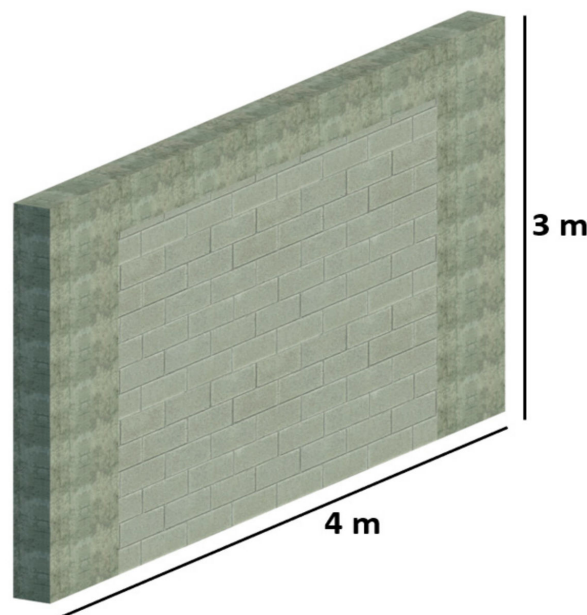

Figure 2. Conventional construction method (S-1).

The concrete used in the columns and beam is composed of 21% Portland cement, 7% water, 39% coarse aggregate, and 33% fine aggregate. A standard, unfinished tempered-steel rod suitable for structural reinforcement (rebar) was used for the columns and beam reinforcement. Hollow core concrete masonry units (CMUs) with a unit dimension of $20 \times 20 \times 40 \text{ cm}^3$ were used to construct the wall. The masonries were joined by using mortar that consisted of 83% sand, 11% cement, and 6% limestone.

Plywood with a 17 mm thickness was the only formwork material included in this study, as the other accessories commonly used to set it up (e.g., supporting jacks, clamps, etc.) have a negligible impact and can be reused several times. That plywood would be used twice was assumed, since it can be used at least once on each side. Figure 3 illustrates the flowchart of Scenario 1, and Table 2 summarizes the material quantity of this scenario.

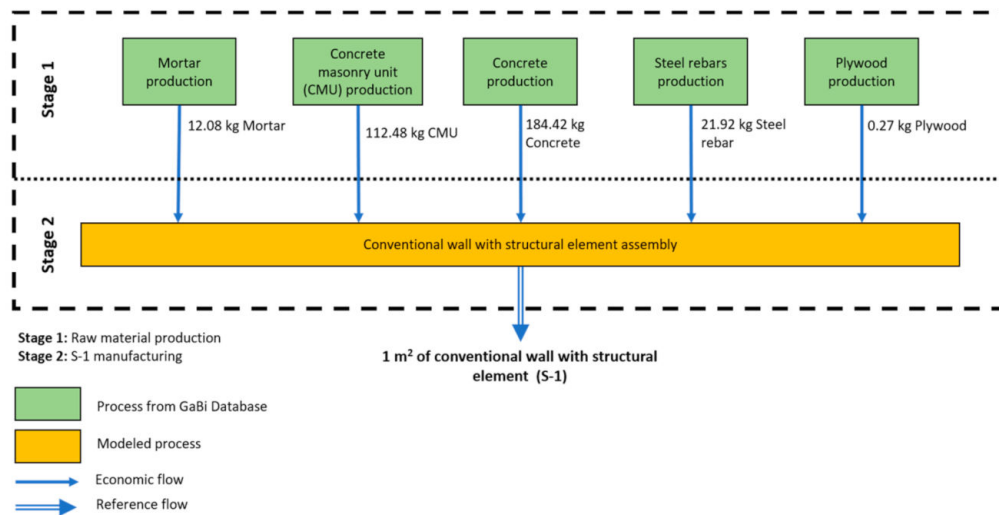

Figure 3. Flowchart of S-1.

2.2.2. Scenario 2

Figure 4 shows the wall element for the 3DCP wall with the reinforced concrete structural system. This wall is initially printed by using 3DCP technology, and the reinforced columns were casted within the walls by first fixing the steel rebar and then pouring concrete within the vicinity of the hollow printed wall. The reinforced beam was casted in a similar manner to that of S-1 with the use of formwork.

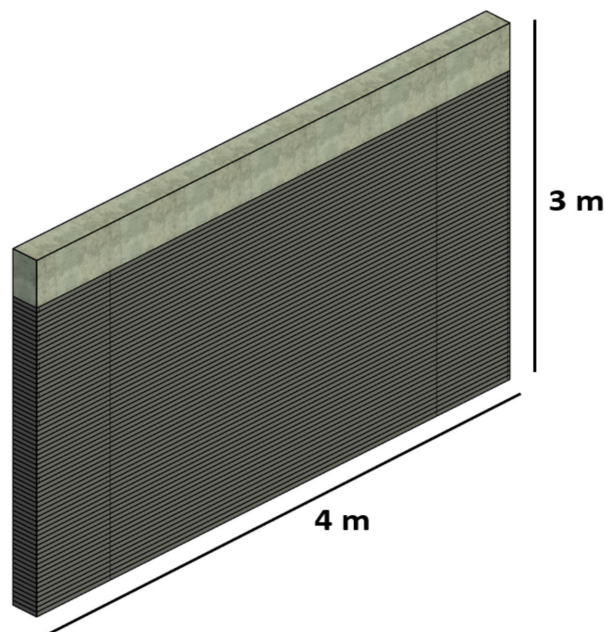

Figure 4. Graphic of 3DCP construction method with reinforced concrete structural system (S-2).

The 3DCP concrete material used in this scenario is M-1, which is composed of ordinary Portland cement, fly ash, microsilica, river sand (2 mm maximum particle size), and polypropylene microfibers. The concrete and steel rebars used for the structural columns and beam are identical to that of the material composition of S-1. The formwork in S-2 was only used to cast the beam, meaning it is similar to that of S-1. Figure 5 illustrates the flowchart of this scenario, and Table 2 summarizes the material composition of the function unit.

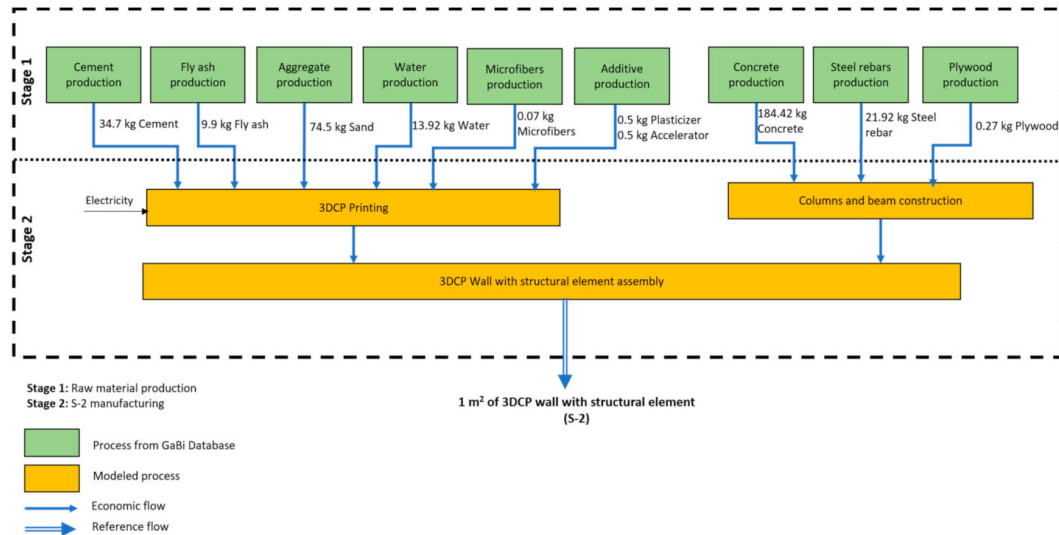

Figure 5. Flowchart of S-2.

Table 2. Material inventory for S-1 and S-2.

Material	Quantity			
	Representative of 12 m ² Wall		Representative of 1 m ² Wall	
	S-1	S-2	S-1	S-2
Structural Concrete (kg)	2213.00	2213.00	184.42	184.42
Steel Rebar (kg)	263.00	263.00	21.92	21.92
Concrete Masonry Unit (kg)	1349.70	-	112.48	-
Mortar (kg)	145.00	-	12.08	-
Plywood (kg)	126.00	3.20	10.50	0.27
3DCP Concrete (m ³)	-	0.70	-	0.06

2.2.3. Scenario 3 and 4

Figure 6 shows the wall section for S-3 and S-4; two concrete mixtures were evaluated for 3D printing. The mixture used in S-3 is a high-performance concrete (M-1) composed of ordinary Portland cement, fly ash, microsilica, river sand (2 mm maximum particle size), and polypropylene microfibers. In addition, the mixture incorporates polypropylene microfibers (used to reduce the shrinkage and deformation in the plastic state), Alkali-free accelerators to control the setting time, and polycarboxylic ether superplasticizers (to maintain concrete workability with a low water/cement ratio for proper 3D printing). The environmental impact of microsilica is not considered, as microsilica is a waste product from the silicon and ferrosilicon alloys; therefore, the environmental is considered negligible.

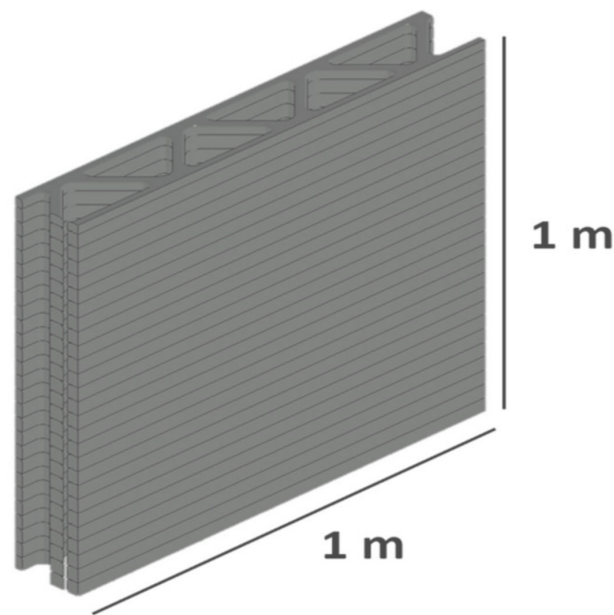

Figure 6. Graphic of 3DCP wall section for (S-3) and (S-4).

The second concrete mixture (Mix-2) for S-4 uses the same material as S-3, except for the river sand. To reduce the weight of the concrete material and to improve its thermal insulation properties, river sand was replaced with expanded perlite (EXP) with a maximum particle size of 4 mm [32]. Perlite is a hydrated amorphous-volcanic silicate glass with a volume that rapidly expands to between 5 and 20 times its original volume when heated to 900–1200 °C, forming EXP [33]. The pore structure imbued upon EXP during this expansion process provides it with excellent thermal insulating properties and weighs less than common concrete aggregate lithologies (i.e., limestone, sandstone, or granitic rocks), gaining the material great attention as a potential aggregate for concrete [34–37]. The mixture for S-4 results in a lightweight and high-strength concrete that has favorable thermal insulation properties. Detailed information on the material characterization can be found in [32]. Figure 7 illustrates the flowchart of S-3 and S-4.

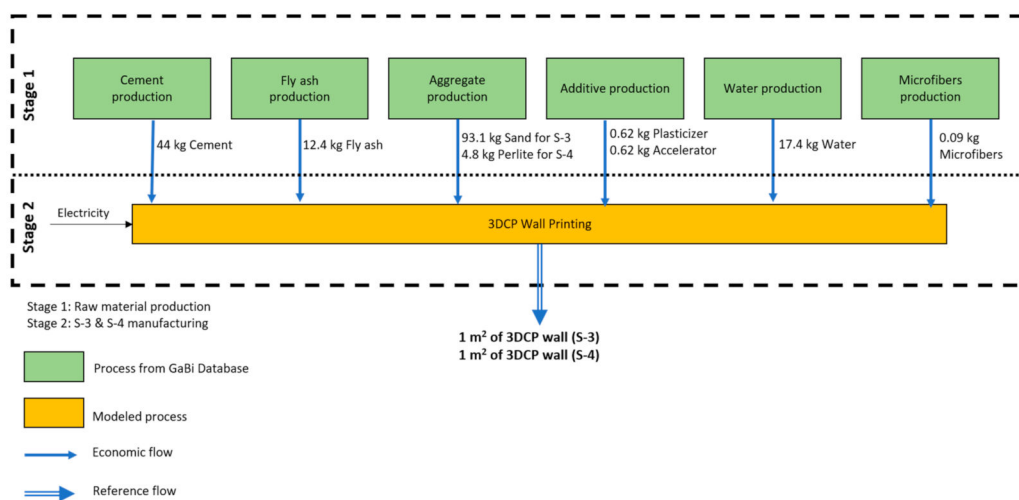

Figure 7. Flowchart of S-3 and S-4.

Table 3 summarizes the material proportion of each concrete mixture. In total, volumetric 3DCP material used in S-3 and S-4 are 0.075 m³.

Table 3. Material proportions of 3DCP concrete mixtures.

Material	Mix-1	Mix-2
Cement (kg/m ³)	579	579
Fly ash (kg/m ³)	165	165
Microsilica (kg/m ³)	83	83
Sand (kg/m ³)	1241	0
Perlite (kg/m ³)	0	63.9
Water (kg/m ³)	232	232
Microfiber (kg/m ³)	1.2	1.2
Super-Plasticizer (kg/m ³)	8.27	8.27
Accelerator (kg/m ³)	8.27	8.27

2.2.4. Electricity Consumption for 3DCP Process

The electricity sources used to model the electricity flow is based 100% on natural gas energy sources for electricity generation. The total energy consumption required to construct the wall by using the conventional method is not accounted for because it is undertaken manually. For the 3DCP wall, the Putzmeister MP25 machine was considered to mix and pump the concrete, and the ABB robot (IRB6700) was used to control and automate the nozzle movement to print the wall. The total energy consumed (EC) in the printing of one wall is given in the following equation:

$$EC = (P_d)(t) \quad (1)$$

where EC is measured in kilowatt-hour (kWh), P_d represents the power demand measured in kilowatts (kW), and t represents the total printing time measured in hours (h). The power demand value of each machine was taken from the equipment datasheet. The time required to print one square meter was calculated by running multiple trials to define the optimal robot speed that satisfies the 3D-printing parameters (pumpability, extrudability, and buildability), and it was found to be 200 mm/s (12 m/min). The pumping rate to match the printing setup was 6 L/min, and it was found that the total amount of concrete needed to print one square meter wall is $0.075 \text{ m}^3 = 75 \text{ L}$ (L). Thus, the total printing time is found by the following equation:

$$t = \frac{\text{total amount of concrete}}{\text{pumping rate}} = \frac{75 \text{ L}}{6 \text{ L/min}} = 12.5 \text{ min} = 0.21 \text{ h} . \quad (2)$$

The robot manufacturing and construction process's impact is neglected because it has only negligibly contributed to the overall energy consumption involved in the 3D-printing process [1,38]. Table 4 summarizes the overall electric consumption of kWh required for printing a wall of one square meter.

Table 4. Summary of the energy requirement during the construction phase in the 3DCP wall.

Equipment	Power Requirement (kW)	Electricity Consumption (kWh)
Mixer and pump	7.38	1.55
Robotic arm	3.40	0.71
Total		2.26

2.3. Life Cycle Impact Assessment (LCIA)

The life cycle impact assessment (LCIA) is a method used to correlate the intensity of the LCA results with their environmental effects. The LCIA is conducted by using environmental impact factors that align with the goal and scope of the study. Potential impacts are reported in kilograms units of an equivalent relative contribution (eq) to the emission being measured (i.e., kg CO₂eq for CO₂ emission). This study used TRACI (a tool for reduction and assessment of chemicals and other environmental

impacts) to categorize and characterize the inventory emissions [39]. This impact assessment method was developed by the United States Environmental Protection Agency (EPA), to assess the midpoint level environmental impact by a decision-making framework. This impact assessment method has been used in many similar studies [40–43].

The environmental impact categories studied in this work are listed in Table 5.

Table 5. Environmental-impact categories evaluated.

Environmental Impact Categories	Description	Unit of Measurement
Global Warming Potential (GWP)	A measure of GHG emissions leading to the Earth's greenhouse effects	kg CO ₂ eq
Acidification Potential (AP)	A measure of emissions that creates an acidic effect in the environment. Unit of measurement	kg SO ₂ eq
Eutrophication Potential (EP)	Measures the impacts of high levels of macronutrients (mainly nitrogen (N) and phosphorus (P)) in the environment	kg Neq
Smog Formation Potential (SFP)	A measure of ground-level ozone produced by chemical reactions between volatile organic compounds and nitrogen oxides in sunlight	kg O ₃ eq
Fossil Fuel Depletion (FFD)	A measure of the total amount of primary energy extracted from the earth (energy demand from both non-renewable and renewable resources)	MJ

3. Results and Discussion

This section discusses the results of the LCA of the four studied scenarios. The discussion is divided into four sections. The first section presents the LCA results of S-1 and discusses each material's contribution to the environmental impact categories. The subsequent two sections discuss the results of the LCA of S-2, S-3, and S-4. The last section analyzes the overall environmental impact of all four scenarios in terms of the potential impact categories and discusses the benefits that 3DCP affords over conventional construction methods. In addition, this last section includes comparisons with other LCA studies. As discussed earlier, the values determined from S-1 and S-2 are scaled down to a 1 m² wall in order to offer a fair and meaningful comparison with the other scenarios.

3.1. Environmental Impact of S-1

This section dissects the LCA of conventional concrete construction by assessing the contribution of materials to the environmental impact. Figure 8 illustrates the contributions of reinforcement steel, structural concrete, concrete masonry units, mortar, and formwork to the environmental impact categories of GWP, AP, EP, SFP, and FFD. Structural concrete appears to contribute significantly in all five impact categories due to its use of cement and its large volumetric quantity in building the wall. Reinforcing steel was found to contribute significantly in terms of GWP, AP and FFD. Similarly, the formwork contributes to approximately 20% of the total EP, and, in 3DCP, its contribution is eliminated. Mortar is seen to contribute minimally across all environmental impact categories because the quantity used is smaller than the other materials. An interesting feature is seen in the GWP effect of formwork, where a negative 2.82 kg CO₂eq is observed. The negative value is due to the plywood's (used as formwork) absorption of CO₂ from trees (timber) as it grows to outweigh the emissions of CO₂ from the machinery and equipment used for harvesting and processing the timber [44,45].

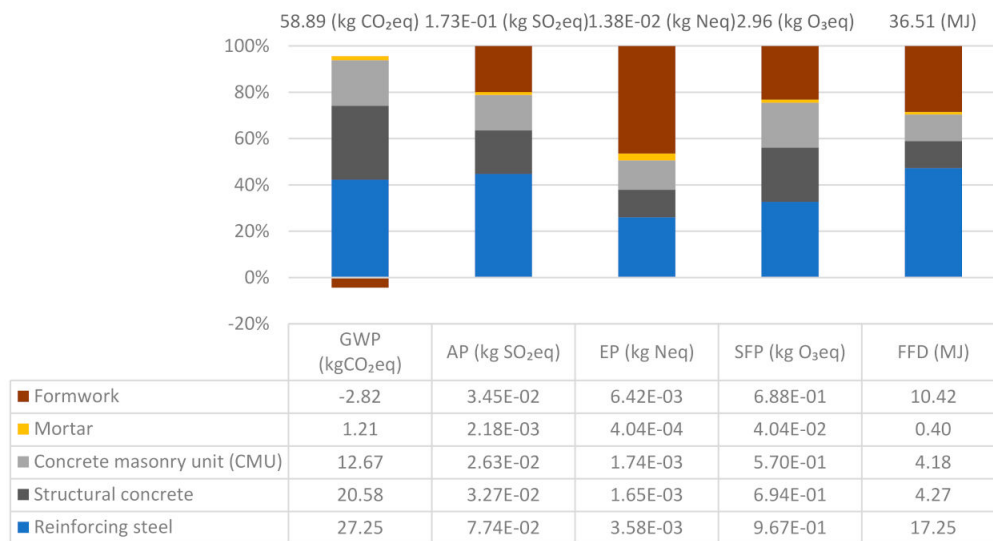

Figure 8. Detailed contribution of the different materials in S-1.

3.2. Environmental Impact of S-2

The materials' contributions to the environmental impact of S-2 are shown in Figure 9. It is clear that a significant portion of the environmental impact in all the categories stems from the use of structural concrete and steel reinforcement. The same negative impact from the plywood used in the formworks can be seen in the GWP; however, this amount is less than that from S-1. This is attributed to the fact that the S-2 formwork is only used to cast the reinforcement beam and not the columns, because the 3DCP walls act as column molds.

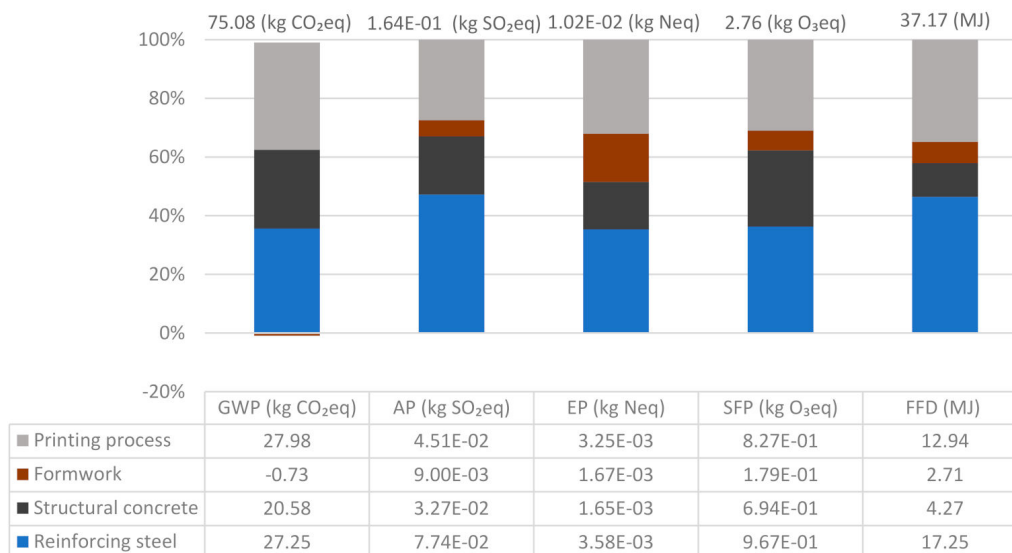

Figure 9. Detailed contribution of the different materials in S-2.

3.3. Environmental Impact of S-3 and S-4

Figure 10 explores the environmental impacts of the material and printing process in purely 3DCP scenarios (S-3 and S-4). Cement gives the greatest contribution to GWP, AP, and SFP. This is not surprising, as it is a well-established fact that the production of cement carries a large carbon footprint [46]. Large aggregates cannot be incorporated into 3D printable concrete mixtures, due to issues with the printing nozzle becoming embedded. To adjust for this, the amount of cement in 3DCP is greater than that of conventional concrete to ensure the printed structure maintains its integrity of strength and form.

The comparison between the two concrete mixtures (high-performance concrete versus lightweight concrete) shows that the use of EXP in lightweight concrete decreases the GWP, AP, EP, and FFD contribution of sand from high-performance concrete by nearly 50%. This reduction translates into a 4%, 5%, 0.5%, 11%, and 21% reduction in the total GWP, AP, EP, SFP, and FFD emissions of the lightweight 3D-printed wall (S-4) versus the wall built by 3D printing of high-performance concrete (S-3).

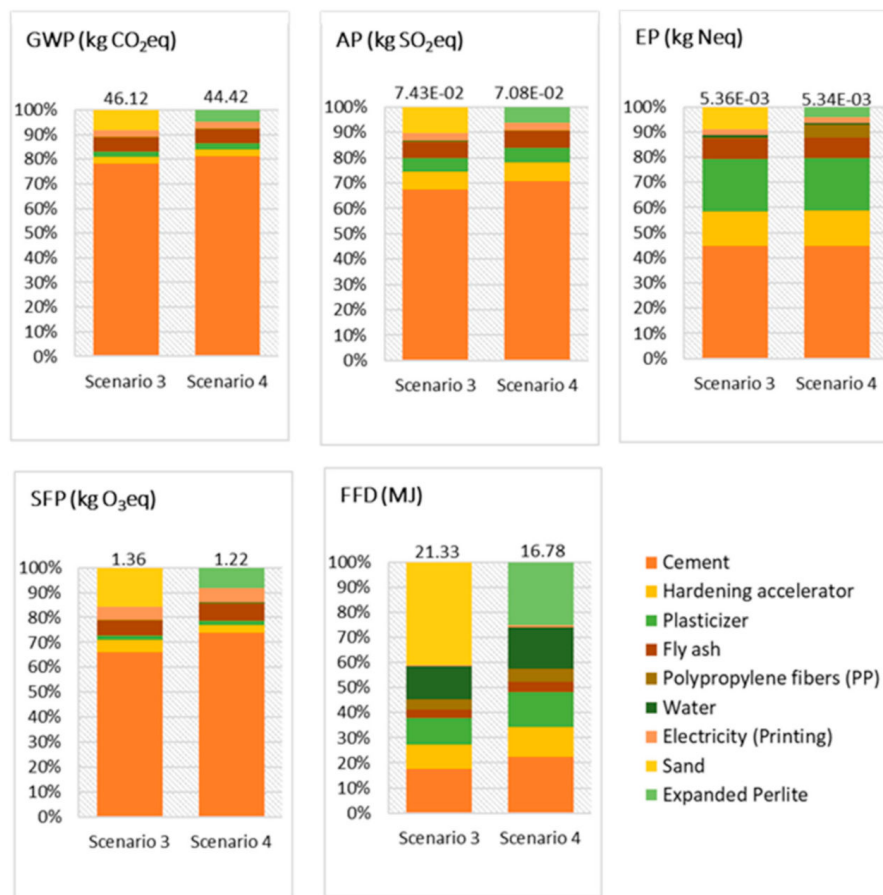

Figure 10. Breakdown of environmental impact per material for S-3 and S-4.

Tables 6 and 7 show the values of the five emission categories produced by each material in S-3 and S-4, respectively. The volumetric replacement of sand with EXP did decrease the overall environmental impact in all five categories; however, the most significant difference is observed in SFP and FFD, with a total decrease of 0.14 kg O₃eq and 4.55 MJ, respectively.

Table 6. Breakdown of material environmental impact contribution of S-3.

Material	GWP (kg CO ₂ eq)	AP (kg SO ₂ eq)	EP (kg Neq)	SFP (kg O ₃ eq)	FFD (MJ)
Cement	36.00	5.01E-02	2.39E-03	9.01E-01	3.77
Hardening Accelerator	1.26	5.21E-03	7.36E-04	6.71E-02	1.99
Plasticizer	1.14	4.01E-03	1.12E-03	2.22E-02	2.32
Fly Ash	2.49	4.60E-03	4.39E-04	8.02E-02	0.68
Polypropylene Fibers	0.20	3.15E-04	2.68E-05	4.96E-03	0.89
Water	0.08	1.86E-04	4.58E-05	3.30E-03	2.80
Electricity	1.08	2.06E-03	1.23E-04	6.93E-02	0.08
Sand	3.87	7.79E-03	4.84E-04	2.15E-01	8.80
Total	46.12	7.43E-02	5.36E-03	1.36E+00	21.33

Table 7. Breakdown of material environmental impact contribution of S-4.

Material	GWP (kg CO ₂ eq)	AP (kg SO ₂ eq)	EP (kg Neq)	SFP (kg O ₃ eq)	FFD (MJ)
Cement	36.00	5.01E-02	2.39E-03	9.01E-01	3.77
Hardening Accelerator	1.26	5.21E-03	7.36E-04	3.71E-02	1.99
Plasticizer	1.14	4.01E-03	1.12E-03	2.22E-02	2.32
Fly Ash	2.48	4.59E-03	4.38E-04	8.00E-02	0.68
Polypropylene Fibers	0.20	3.15E-04	2.68E-04	4.96E-03	0.89
Water	0.08	1.86E-04	4.58E-05	3.30E-03	2.80
Electricity	1.08	2.06E-03	1.23E-04	6.93E-02	0.08
Expanded Perlite	2.18	4.35E-03	2.17E-04	1.01E-01	4.25
Total	44.42	7.08E-02	5.34E-03	1.22E+00	16.78

3.4. Overall Environmental Impact Comparison

Figure 11 shows the overall environmental impact of all four scenarios in terms of the GWP, AP, EP, SFP, and FFD. It is immediately evident that, without any reinforcement, and regardless of the concrete material used, 3DCP outperforms conventional concrete construction in all impact categories. The bar graph is designed to visually represent the percentage difference in the environmental impact categories of all scenarios. Thus, each bar graph indicates the percentage of the total equivalent relative contribution of emissions. In particular, Scenario 1 generates 58.89 kg CO₂eq (approximately 78% of the 75.08 kg CO₂eq GWP) of greenhouse gas emissions, whereas pure 3DCP in Scenarios 3 and 4 generates 46.12 kg CO₂eq (approximately 61% of the 75.09 kg CO₂eq GWP) and 44.42 kg CO₂eq (approx. 59% of the 75.09 kg CO₂eq GWP) of greenhouse gas emissions, respectively. Absent any reinforcement, 3DCP decreases GHG emissions by approximately 20% from conventional concrete construction. However, when 3DCP is combined with reinforced columns and beams, the GWP spikes to 75.08 kg CO₂eq, higher than S-1, S-3, and S-4. This GWP emission is understandable because S-2 uses the concrete mixture of S-3 with higher cement content that allows for proper printing and ultimately contributes to a larger carbon footprint. It is then also burdened with the reinforced column and beams that contribute further to GHG emissions.

Figure 11 also shows that 3DCP can significantly reduce AP, EP, and SFP emissions by approximately 50–55% from conventional concrete construction (S-1). Additionally, there is roughly a 28% decrease in EP emissions in S-2, as compared to S-1, and a slight reduction in AP and SFP emissions in S-2 compared to S-1, further highlighting the benefits of 3DCP over conventional construction methods—despite the use of reinforcement material.

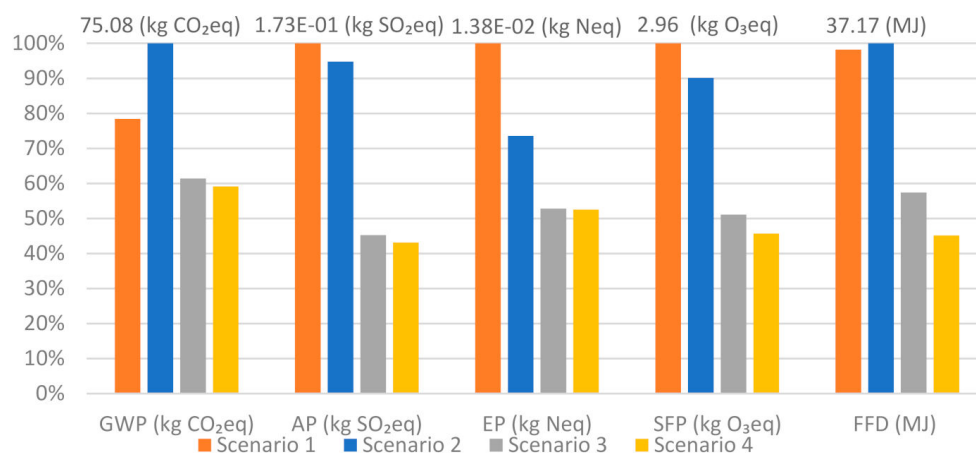
**Figure 11.** Overall life cycle assessment (LCA) results of the four studied scenarios.

In terms of fossil fuel depletion, 3DCP in S-3 and S-4 achieves approximately half of the value from both S-1 and S-2. In addition, S-2 has a slightly higher FFD value than S-1, because it incorporated the high energy contributions of conventional methodology and 3DCP. The quantitative values of the five environmental impact categories for all three scenarios are given in Table 8. Looking at the high-level analysis of all four studied scenarios' environmental effects, it is evident that 3DCP holds great potential in reducing the negative effects associated with concrete construction.

Table 8. Comparison of the GWP, AP, EP, SFP, and FFD all three studied scenarios' categories.

Scenario	GWP (kg CO ₂ eq)	AP (kg SO ₂ eq)	EP (kg Neq)	SFP (kg O ₃ eq)	FFD (MJ)
Scenario 1	58.89	1.73E-01	1.38E-02	2.96	36.51
Scenario 2	75.08	1.64E-01	1.02E-02	2.67	37.17
Scenario 3	46.12	7.43E-02	5.36E-03	1.36	21.33
Scenario 4	44.42	7.08E-02	5.34E-03	1.22	16.78

Most of the current 3DCP projects incorporate the use of standard reinforcements (columns and beams) within the printed structure [16,47,48]. The LCA results in S-1, S-2, and S-3 show the additional negative environmental contribution that reinforcement carries in 3DCP structure. These results indicate that the selection of 3DCP to decrease the environmental effect of construction is challenged when the use of conventional reinforcement is implemented. Thus, this raises the important question of whether reinforcement is needed when using 3DCP technology; and if so, should alternate reinforcement strategies suitable for 3DCP be examined? The findings of the LCA analysis in this paper provide motivation to further investigate and develop alternative reinforcement methods.

Moreover, the results given from the LCA of all four scenarios indicate that 3DCP holds great potential in the reduction of a negative environmental impact, as compared to conventional concrete construction methods. The development of a more sustainable concrete material suitable for 3DCP can further optimize the environmental impact of construction. In this paper, the alternate concrete material analyzed in S-3 did not hold significant environmental improvements when evaluated from cradle to gate. However, because EXP holds good thermal properties, the lightweight printable concrete's environmental benefits are expected to be significant later down the life cycle, particularly in the operational phase. Thus, 3DCP can be coupled with more sustainable concrete, to further enhance the total environmental impact, from cradle to grave. Ultimately, the outcomes and findings in this paper support the advancement of 3DCP technology and push for investment in (1) the development of more sustainable printable concrete material, (2) in thoroughly testing the integrity of printed structures and buildings, and (3) in driving policy in the adoption of 3DCP as a viable technology for building construction.

The study of 3DCP technology and its environmental impact is very limited thus far, only recently gaining global attention. Despite the limited contributions in this field, several works have been published investigating the environmental impact of 3DCP versus conventional construction methods. In particular, the work of Reference [6] indicates that the use of 3DCP lowers the GWP by approximately 85.9%, as compared to the pre-cast method, which is associated with high volumes of concrete and steel reinforcement. Some of the literature has claimed that 3DCP has achieved higher emission rates than conventional methods; however, these methods consider wider system boundaries, such as transportation and variable thickness in the functional units, that were not addressed in this work [24]. Additionally, it has been highlighted that enhanced printable concrete material can further improve the environmental performance of 3DCP. This work has shown that incorporating EXP in place of the sand aggregate reduces the negative emission in several environmental categories. Similarly, Long, et al. (2019) investigated claims that 1 wt% microcrystalline cellulose (MMC) can act as a replacement for the binder in 3DCP's concrete mixture, which enables the reduction of CO₂ emissions by 6.82%, as compared to mortars without MCC.

4. Sensitivity Analysis

There exists a certain degree of uncertainty in LCA studies that arise from various factors, including system boundaries, data inventory accuracy, and model assumption. This study considered all of the major factors that could or do affect the environmental impact of a construction method; thus, the uncertainty introduced has a minimal impact on the results. However, to fully assess the impact of the uncertainties on the outcome, this paper conducts a sensitivity analysis to assess the effect the energy source, printing speed, and cement type. For each analysis scenario, one of the three parameters were varied, and the other two were kept constant.

4.1. Energy Source

To analyze the effect of the energy source on the outcome of the study, different on-site electricity sources were considered for the printing process. This variation allows for the analysis of how various electricity generation to power the 3DCP effect the result of the LCA study. Each electricity grid mix has a different percentage of different energy sources such as hard coal, nuclear, hydropower, biomass, wind power, photovoltaic, geothermal, crude oil, lignite, coal gases, heavy fuel gas, biogas, waste, and solar thermal. The electricity source is dependent on the geographical location of the printing process. Figure 12 shows the effect of using a different electricity grid mix on the five environmental impacts.

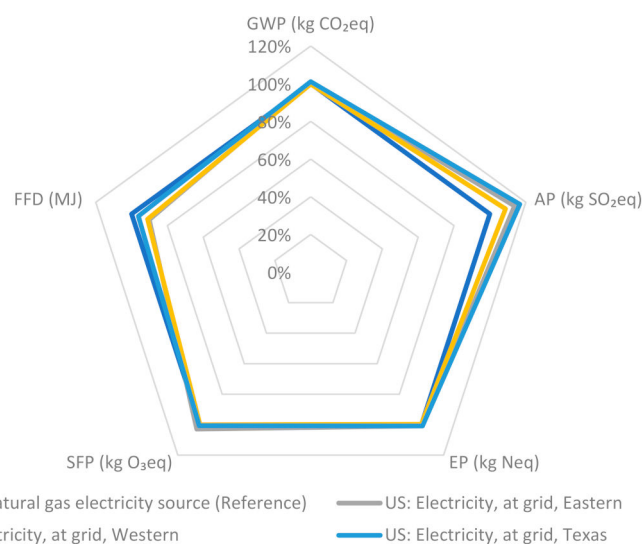

Figure 12. Sensitivity analysis results of using different electricity grid mix.

Table 9 outlines the effects that the various electricity grid mixes shown in Figure 12 have on the five environmental-impact categories. It can be seen that the various electricity grid mixtures had little effect on GWP, EP, and SFP. However, there is some noticeable impact in AP when using the electricity grid in the Eastern US and Texas, when compared to the reference, which is based on electricity generation based on natural gas.

Table 9. Effect of electricity grid mix on the environmental-impact categories.

Impact Assessment	100% Natural Gas (Reference)	US: Electricity, at Grid, Eastern	US: Electricity, at Grid, Western	US: Electricity, at Grid, Texas, US
GWP (kg CO ₂ eq.)	46.1	46.4	46.0	46.6
AP (kg SO ₂ eq.)	7.43E-02	8.45E-02	8.08E-02	8.67E-02
EP (kg Neq.)	5.37E-03	5.42E-03	5.36E-03	5.42E-03
SFP (kg O ₃ eq.)	1.36	1.40	1.36	1.37
FFD (MJ)	21.3	19.2	19.4	20.5

4.2. Printing Speed

This section studies the effect of different printing speeds on the LCA result sensitivity. In the reference model, the printing speed was 200 mm/s. Figure 13 illustrates the effect of various printing speeds (100, 300, and 400 mm/s) on the impact categories. In addition, Table 10 quantifies the effect of printing speed on the environmental impact category. In general, there is a negligible effect of printing speed on most of the impact categories, except for FFD. Decreasing printing speed negatively affects FFD. In particular, reducing the printing speed from 200 mm/s (reference speed) to 100 mm/s increases the FFD by 16%.

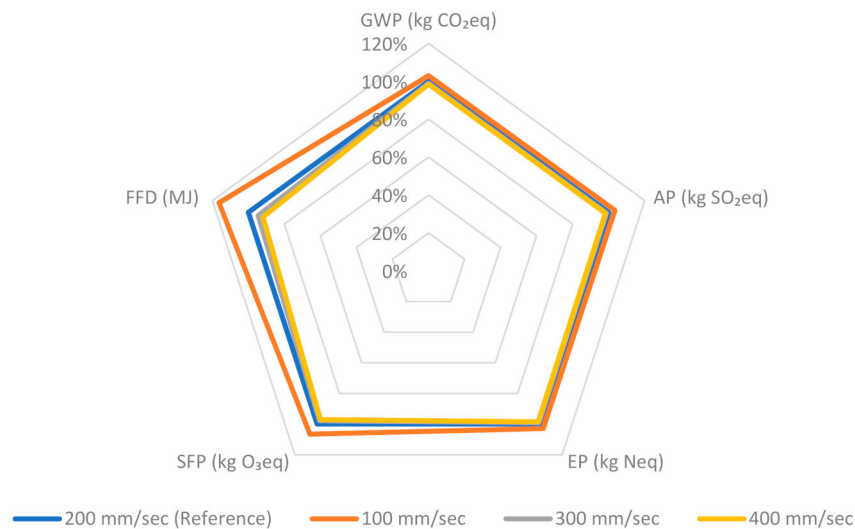

Figure 13. Sensitivity analysis results of using different printing speed.

Table 10. Effect of the printing speed on the different environmental impact categories.

Impact Assessment	100 mm/s	200 mm/s (Reference)	300 mm/s	400 mm/s
GWP (kg CO ₂ eq.)	47.8	46.4	45.9	45.7
AP (kg SO ₂ eq.)	7.75E-02	7.49E-02	7.4E-02	7.36E-02
EP (kg Neq.)	5.56E-03	5.40E-03	5.35E-03	5.32E-03
SFP (kg O ₃ eq.)	1.47	1.38	1.35	1.34
FFD (MJ)	25.7	22.1	20.9	20.3

4.3. Cement Grade

In order to assess the effect of various cement grade on the outcome of the LCA study, two grades of ordinary cement type I (CEM I 32.5 and CEM I 52.5) were compared to the reference cement (CEM I 42.5). Figure 14, below, illustrates the effect of cement grade on the environmental impact categories. It is important to note that the scale is magnified in order to show the percentage of variation between the cement grade more clearly. Cement is known to have a significant environmental impact, as seen from its contribution to the LCA study results (in all four studied scenarios). As expected, varying the cement grade generated variations in the impact categories (see Table 11). However, these variations are not significant ($\pm 2\%$) when compared to the reference cement grade.

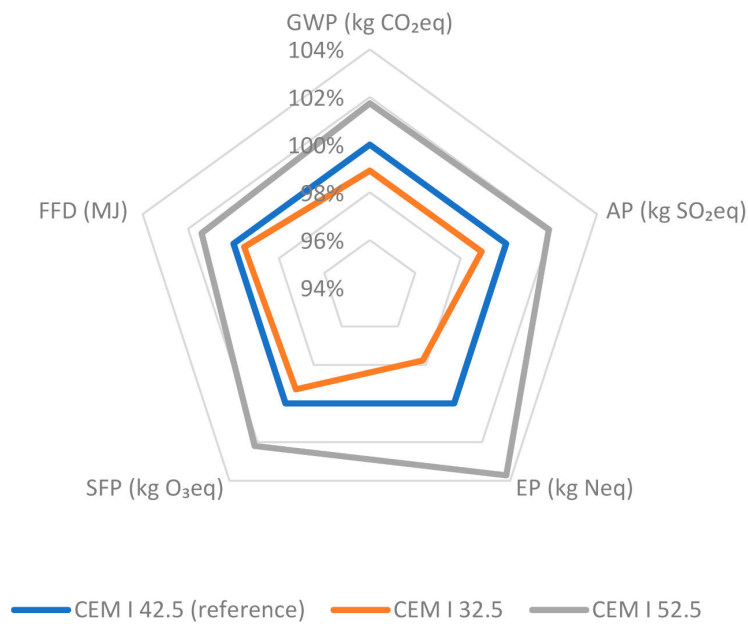

Figure 14. Sensitivity analysis results of using different cement grades.

Table 11. Effect of the cement grade on the different environmental-impact categories.

Impact Assessment	CEM I 42.5 (Reference)	CEM I 32.5	CEM I 52.5
GWP (kg CO ₂ eq.)	46.1	45.6	46.9
AP (kg SO ₂ eq.)	7.43E-02	7.35E-02	7.57E-02
EP (kg Neq.)	5.37E-03	5.25E-03	5.57E-03
SFP (kg O ₃ eq.)	1.36	1.35	1.39
FFD (MJ)	21.3	21.2	21.6

5. Conclusions

Three-dimensional concrete printing is an up-and-coming technology that is being adopted globally due to its diverse set of advantages: reduced costs, saved time, and decreased labor requirements. Additionally, 3DCP enhances safety on-site, increases design flexibility, and reduces environmental impact. Although 3DCP has been receiving great interest and attention in both the industrial and academic worlds, there have been limited research efforts dedicated to studying the environmental benefits associated with it over conventional methods. This work investigated the environmental impact tradeoff between building an external load-bearing wall via 3DCP and using the conventional construction methodology. Four case scenarios were studied by using a cradle-to-gate LCA to investigate the environmental impact of conventional concrete construction: 3DCP with reinforcement elements, 3DCP without any reinforcement, and 3DCP without any reinforcement and utilizing a lightweight printable concrete material. It was found that 3DCP was able to significantly reduce environmental effects in terms of GWP, AP, EP, SFP, and FFD from conventional construction methods.

Moreover, the use of lightweight concrete where sand was replaced with EXP in 3DCP showed to further decrease the GWP, AP, EP, and FFD impact from those of normal printable concrete materials. These findings support the construction industry, deciding to direct itself not only to investigate 3D-printed infrastructure but also to explore novel printable materials that uphold the integrity of the built structure and reduce negative environmental impacts.

Although 3DCP is a relatively new technology in the construction sector, several noteworthy projects have been built with it. However, until recently, most of the demonstration buildings and structures incorporated the use of reinforced structures (beams and columns) within the 3DCP structure to ensure all building codes and guidelines were met, as well as to maximize safety. This study

has shown that, when 3DCP is used along with reinforced elements, there are no environmental benefits over conventional methods. In fact, 3DCP with reinforcements is associated with higher GWP and FFD emissions than the studied conventional method. The end results signify that future research must focus on testing 3DCP structures for strength and safety. Research efforts should concentrate on developing novel reinforcement techniques that are suitable for 3DCP rather than adopting reinforcement techniques specifically meant for conventional concrete construction methods.

Supplementary Materials: The following are available online at <http://www.mdpi.com/2075-5309/10/12/245/s1>.

Author Contributions: Conceptualization, M.M., E.M., and S.G.A.-G.; data curation, M.M.; formal analysis, M.M.; funding acquisition, E.M. and S.G.A.-G.; methodology, M.M., E.M., and S.G.A.-G.; project administration, S.G.A.-G.; supervision, E.M. and S.G.A.-G.; writing—original draft, M.M.; writing—review and editing, E.M. and S.G.A.-G. All authors have read and agreed to the published version of the manuscript.

Funding: This publication was made possible by the TÜBİTAK—QNRF Joint Funding Program grant (AICC02-0429-190014) from the Scientific and Technological Research Council of Turkey and Qatar National Research Fund (QNRF). Any opinions, findings, and conclusions or recommendations expressed in this material are those of the author(s) and do not necessarily reflect the views of TÜBİTAK or QNRF.

Conflicts of Interest: The authors declare no conflict of interest.

References

1. Agustí-Juan, I.; Habert, G. Environmental design guidelines for digital fabrication. *J. Clean. Product.* **2017**, *142*, 2780–2791. [[CrossRef](#)]
2. Scrivener, K.L.; John, V.M.; Gartner, E.M. Eco-efficient cements: Potential economically viable solutions for a low-CO₂ cement-based materials industry. *Cem. Concr. Res.* **2018**, *114*, 2–26. [[CrossRef](#)]
3. Szabó, L.; Hidalgo, I.; Cisar, J.C.; Soria, A.; Russ, P. *Report EUR Energy Consumption and CO₂ Emissions from the World Cement Industry*; European Commission Joint Research Centre: Brussels, Belgium, 2003; p. 20769.
4. Andrew, R.M. Global CO₂ emissions from cement production. *Earth Syst. Sci. Data* **2018**, *10*, 195–217. [[CrossRef](#)]
5. Marzouk, M.; Azab, S. Environmental and economic impact assessment of construction and demolition waste disposal using system dynamics. *Res. Conserv. Recycl.* **2014**, *82*, 41–49. [[CrossRef](#)]
6. Weng, Y.; Li, M.; Ruan, S.; Wong, T.N.; Tan, M.J.; Yeong, K.L.O.; Qian, S. Comparative economic, environmental and productivity assessment of a concrete bathroom unit fabricated through 3D printing and a precast approach. *J. Clean. Product.* **2020**, *261*, 121245. [[CrossRef](#)]
7. Khoshnevis, B. Automated construction by contour crafting—Related robotics and information technologies. *Autom. Construc.* **2004**, *13*, 5–19. [[CrossRef](#)]
8. Khoshnevis, B.; Hwang, D.; Yao, K.-T.; Yeh, Z. Mega-scale fabrication by contour crafting. *Int. J. Ind. Syst. Eng.* **2006**, *1*, 301–320. [[CrossRef](#)]
9. International Organization for Standardization. *Environmental Management: Life Cycle Assessment; Principles and Framework*; ISO: Geneva, Switzerland, 2006.
10. Junnila, S.; Horvath, A.; Guggemos, A.A. Life-cycle assessment of office buildings in Europe and the United States. *J. Infrastruct. Syst.* **2006**, *12*, 10–17. [[CrossRef](#)]
11. Bahramian, M.; Yetilmezsoy, K. Life cycle assessment of the building industry: An overview of two decades of research (1995–2018). *Energy Build.* **2020**, *219*, 109917. [[CrossRef](#)]
12. Nwodo, M.N.; Anumba, C.J. A review of life cycle assessment of buildings using a systematic approach. *Build. Environ.* **2019**, *162*, 106290. [[CrossRef](#)]
13. Saade, M.R.M.; Guest, G.; Amor, B. Comparative whole building LCAs: How far are our expectations from the documented evidence? *Build. Environ.* **2020**, *167*, 106449. [[CrossRef](#)]
14. Häfliger, I.-F.; John, V.; Passer, A.; Lasvaux, S.; Hoxha, E.; Ruschi, M.; Saade, M.; Habert, G. Buildings environmental impacts' sensitivity related to LCA modelling choices of construction materials. *J. Clean. Product.* **2017**, *156*, 805–816. [[CrossRef](#)]
15. Agustí-Juan, I.; Habert, G. An Environmental Perspective on Digital Fabrication in Architecture and Construction. In Proceedings of the 21st International Conference on Computer-Aided Architectural Design Research in Asia CAADRIA, Melbourne, FL, USA, 30 March–2 April 2016; pp. 797–806.

16. Asprone, D.; Auricchio, F.; Menna, C.; Mercuri, V. 3D printing of reinforced concrete elements: Technology and design approach. *Construct. Build. Mater.* **2018**, *165*, 218–231. [[CrossRef](#)]
17. Camacho, D.D.; Clayton, P.; O'Brien, W.J.; Seepersad, C.; Juengar, M.; Ferron, R.; Salamone, S. Applications of additive manufacturing in the construction industry—A forward-looking review. *Automat. Construct.* **2018**, *89*, 110–119. [[CrossRef](#)]
18. Ghaffar, S.H.; Corker, J.; Fan, M. Additive manufacturing technology and its implementation in construction as an eco-innovative solution. *Automat. Construct.* **2018**, *93*, 1–11. [[CrossRef](#)]
19. Kreiger, M.; Pearce, J.M. Environmental life cycle analysis of distributed three-dimensional printing and conventional manufacturing of polymer products. *ACS Sustain. Chem. Eng.* **2013**, *1*, 1511–1519. [[CrossRef](#)]
20. Kohtala, C.; Hyysalo, S. Anticipated environmental sustainability of personal fabrication. *J. Clean. Product.* **2015**, *99*, 333–344. [[CrossRef](#)]
21. Faludi, J.; Bayley, C.; Bhogal, S.; Iribarne, M. Comparing environmental impacts of additive manufacturing vs traditional machining via life-cycle assessment. *Rapid Prototyp. J.* **2015**, *21*, 14–33. [[CrossRef](#)]
22. Cerdas, F.; Juraschek, M.; Thiede, S.; Herrmann, C. Life cycle assessment of 3D printed products in a distributed manufacturing system. *J. Ind. Ecol.* **2017**, *21*, S80–S93. [[CrossRef](#)]
23. Yao, Y.; Hu, M.; Di Maio, F.; Cucurachi, S. Life cycle assessment of 3D printing geo-polymer concrete: An ex-ante study. *J. Ind. Ecol.* **2020**, *24*, 116–127. [[CrossRef](#)]
24. Alhumayani, H.; Gomaa, M.; Soebarto, V.; Jabi, W. Environmental assessment of large-scale 3D printing in construction: A comparative study between cob and concrete. *J. Clean. Product.* **2020**, *270*, 122463. [[CrossRef](#)]
25. Long, W.-J.; Tao, J.L.; Lin, C.; Gu, Y.; Duan, H.B. Rheology and buildability of sustainable cement-based composites containing micro-crystalline cellulose for 3D-printing. *J. Clean. Product.* **2019**, *239*, 118054. [[CrossRef](#)]
26. Chen, D.; Heyer, S.; Ibbotson, S.; Salonitis, K. Direct digital manufacturing: Definition, evolution, and sustainability implications. *J. Clean. Product.* **2015**, *107*, 615–625. [[CrossRef](#)]
27. Gebler, M.; Schoot Uiterkamp, A.J.M.; Visser, C. A global sustainability perspective on 3D printing technologies. *Energy Policy* **2014**, *74*, 158–167. [[CrossRef](#)]
28. Liu, Y.; van Nederveen, S.; Hertogh, M. Understanding effects of BIM on collaborative design and construction: An empirical study in China. *Int. J. Proj. Manag.* **2017**, *35*, 686–698. [[CrossRef](#)]
29. de Soto, B.G.; Agustí-Juan, I.; Hunhevicz, J.; Joss, S.; Graser, K.; Habert, G.; Adey, B.T. Productivity of digital fabrication in construction: Cost and time analysis of a robotically built wall. *Automat. Construct.* **2018**, *92*, 297–311. [[CrossRef](#)]
30. Tukker, A. Life cycle assessment as a tool in environmental impact assessment. *Environ. Impact Assessm. Rev.* **2000**, *20*, 435–456. [[CrossRef](#)]
31. Morgan, R.K. Environmental Impact Assessment: The State of the Art. *Impact Assem. Proj. Appr.* **2012**, *30*, 5–14. [[CrossRef](#)]
32. Mohammad, M.; Masad, E.; Seers, T.; Al-Ghamdi, S.G. High-Performance Light-Weight Concrete for 3D Printing. In *Second RILEM International Conference on Concrete and Digital Fabrication*; Springer: Cham, Switzerland, 2020; Volume 28, pp. 459–467. [[CrossRef](#)]
33. Berge, B.; Butters, C.; Henley, F. *The Ecology of Building Materials, Chapter 6: Minerals*, 2nd ed.; Berge, B., Butters, C., Henley, T., Eds.; Taylor and Francis: Oxfordshire, UK, 2009.
34. Demirboğa, R.; Gül, R. The effects of expanded perlite aggregate, silica fume and fly ash on the thermal conductivity of lightweight concrete. *Cem. Concr. Res.* **2003**, *33*, 723–727. [[CrossRef](#)]
35. Kramar, D.; Bindiganavile, V. Impact response of lightweight mortars containing expanded perlite. *Cem. Concr. Compos.* **2013**, *37*, 205–214. [[CrossRef](#)]
36. Lanzón, M.; García-Ruiz, P. Lightweight cement mortars: Advantages and inconveniences of expanded perlite and its influence on fresh and hardened state and durability. *Constr. Build. Mater.* **2008**, *22*, 1798–1806. [[CrossRef](#)]
37. Mohammad, M.; Masad, E.; Seers, T.; Al-Ghamadi, S.G. Properties and microstructure distribution of high-performance thermal insulation concrete. *Materials* **2020**, *13*, 2091. [[CrossRef](#)] [[PubMed](#)]
38. Agustí-Juan, I.; Hollberg, A.; Habert, G. Early-Design Integration of Environmental Criteria for Digital Fabrication. In *Life Cycle Analysis and Assessment in Civil Engineering: Towards an Integrated Vision, Proceedings of the Sixth International Symposium on Life-Cycle Civil Engineering (IALCCE 2018), Ghent, Belgium, 28–31 October 2018*; CRC Press: Boca Raton, FL, USA.

39. Bare, J.C. *Tool for the Reduction and Assessment of Chemical and Other Environmental Impacts (TRACI), Version 2.1-User's Manual*; US EPA Office of Research and Development: Washington, DC, USA, 2012.
40. Rajagopalan, N.; Bilec, M.M.; Landis, A.E. Residential life cycle assessment modeling: Comparative case study of insulating concrete forms and traditional building materials. *J. Green Build.* **2010**, *5*, 95–106. [[CrossRef](#)]
41. Phillips, R.; Troup, L.; Fannon, D.; Eckelman, M.J. Triple bottom line sustainability assessment of window-to-wall ratio in US office buildings. *Build. Environ.* **2020**, *182*, 107057. [[CrossRef](#)]
42. Ben-Alon, L.; Loftness, V.; Harries, K.A.; DiPetro, G.; Hameen, E.C. Cradle to site life cycle assessment (LCA) of natural vs conventional building materials: A case study on cob earthen material. *Build. Environ.* **2019**, *160*, 106150. [[CrossRef](#)]
43. Gardner, H.; Garcia, J.; Hasik, V.; Olinzock, M.; Banawi, A.; Bilec, M.M. Materials life cycle assessment of a living building. *Procedia CIRP* **2019**, *80*, 458–463. [[CrossRef](#)]
44. Alcorn, J.A. Global Sustainability and the New Zealand House. Ph.D. Thesis, Victoria University of Wellington, Wellington, New Zealand, 2010.
45. Densley Tingley, D.; Hathway, A.; Davison, B. An environmental impact comparison of external wall insulation types. *Build. Environ.* **2015**, *85*, 182–189. [[CrossRef](#)]
46. Chen, C.; Habert, G.; Bouzidi, Y.; Jullien, A. Environmental impact of cement production: Detail of the different processes and cement plant variability evaluation. *J. Clean. Product.* **2010**, *18*, 478–485. [[CrossRef](#)]
47. Lindemann, H.; Gerbers, R.; Ibrahim, S.; Dietrich, F.; Herrmann, E.; Dröder, K.; Raatz, A.; Kloft, H. Development of a Shotcrete 3D-Printing (SC3DP) Technology for Additive Manufacturing of Reinforced Freeform Concrete Structures. In *First RILEM International Conference on Concrete and Digital Fabrication—Digital Concrete 2018*; Springer: Cham, Switzerland, 2018; Volume 19, pp. 287–298. [[CrossRef](#)]
48. Lloret, E.; Shahab, A.R.; Linus, M.; Flatt, R.J.; Gramazio, F.; Kohler, M.; Langenberg, S. Complex concrete structures: Merging existing casting techniques with digital fabrication. *Comput. Aided Des.* **2015**, *60*, 40–49. [[CrossRef](#)]

Publisher's Note: MDPI stays neutral with regard to jurisdictional claims in published maps and institutional affiliations.



© 2020 by the authors. Licensee MDPI, Basel, Switzerland. This article is an open access article distributed under the terms and conditions of the Creative Commons Attribution (CC BY) license (<http://creativecommons.org/licenses/by/4.0/>).