

Article

Gold Artifacts from the Early Scythian Princely Tomb Arzhan 2, Tuva—Aesthetics, Function, and Technology

Barbara Armbruster ^{1,*} and Caspar Meyer ²

¹ Centre National de la Recherche Scientifique (CNRS)—Laboratoire d'archéologie TRACES, UMR 5608, Université de Toulouse Jean Jaurès, 31058 Toulouse, France

² Bard Graduate Center, Bard College, New York, NY 10024, USA; caspar.meyer@bgc.bard.edu

* Correspondence: barbara.armbruster@univ-tlse2.fr

Abstract: This article explores the extraordinarily rich gold finds from the Early Scythian princely tomb Arzhan 2 in the Republic of Tuva, southern Siberia (late 7th to early 6th centuries BCE), through the methodological framework of the *chaîne opératoire* (operational sequence), in order to reconstruct the objects' processes of manufacture. Through an interdisciplinary study of the finds at the State Hermitage in Saint Petersburg, the principal author analyzed tool marks and surface morphologies, which allow for the comprehensive identification and documentation of the numerous techniques employed in the creation of the often very elaborate jewelry, decorated weapons, and other personal ornaments. The production of both individual pieces and extensive series of thousands of identical trimmings attests to the existence of complex craft processes and workshop organizations. The technological aspects of the gold finds impress through their diversity and outstanding quality, both artistically and in terms of their craftsmanship. As this article will demonstrate, the objects present the earliest evidence for a highly specialized goldsmith artform in southern Siberia.

Keywords: early Scythian goldwork; gold technology; Siberia



Citation: Armbruster, Barbara, and Caspar Meyer. 2024. Gold Artifacts from the Early Scythian Princely Tomb Arzhan 2, Tuva—Aesthetics, Function, and Technology. *Arts* 13: 46. <https://doi.org/10.3390/arts13020046>

Academic Editor: Michelle Facos

Received: 24 November 2023

Revised: 17 January 2024

Accepted: 19 January 2024

Published: 27 February 2024



Copyright: © 2024 by the authors. Licensee MDPI, Basel, Switzerland. This article is an open access article distributed under the terms and conditions of the Creative Commons Attribution (CC BY) license (<https://creativecommons.org/licenses/by/4.0/>).

1. Introduction

From 2000–2004, the kurgan Arzhan 2 in the Republic of Tuva, southern Siberia (Figure 1), was excavated by a German–Russian team under the joint auspices of the German Archaeological Institute in Berlin and the State Hermitage in Saint Petersburg (Čugunov et al. 2010; Parzinger 2011). Measuring 75 m in diameter and 2 m in height, and surrounded by stelae, deer stones, and stone circles, the mighty funerary monument is one of the most important tombs in the kurgan chain of the Arzhan Valley, surpassed only by the Great Kurgan of Arzhan 1 (Griaznov 1984). The construction of the kurgan dates to the late 7th century BCE and has been assigned to the Aldy Bel' stage in the archaeological chronology of Tuva (Čugunov et al. 2010; Zaitseva et al. 2004). The burial site was apparently also a ritual place and remained structurally intact in later periods, as the site continued to be visited by equestrian nomads for an extended period. Due to the kurgan's geographical location in the eastern steppe belt of southern Siberia, none of the cultural influences sometimes detected in the nomadic metalwork of western Eurasia are present here. In 2006, a selection of outstanding objects from Arzhan 2 was published in a catalog conceived for a general readership (Čugunov et al. 2006). The structure of the complex, containing a main tomb and several secondary burials, as well as the scientific research on the exceptionally rich finds, were comprehensively published (Čugunov et al. 2010)¹. In addition, the excavations and objects were discussed in a series of articles and exhibition catalogs (Alexeyev 2012; Simpson and Pankova 2017a; Čugunov et al. 2003; Parzinger 2009, 2011, 2017; Piotrovskij and Parzinger 2004).

In 2001, these excavations revealed an intact princely tomb (Tomb 5), which contained—in addition to the spectacular textiles and objects in iron, bronze, and wood—the most significant collection of goldwork of the Early Scythian period in Siberia to date (Figure 2). In

total, the princely tomb contained around 9300 artifacts. The untouched wooden burial chamber contained the remains of a man and a woman of the same rank, equipped with around 5600 gold objects, in addition to several hundred thousand miniature gold beads. This diverse multitude of artisanal creations offers unprecedented insight into not only the design, processing, and use of extraordinary precious metal finds, but also into their symbolic power and sociocultural background.



Figure 1. Map of the Eurasian Steppe, with the location of Arzhan 2. Cartography by Gabriel Moss.



Figure 2. Arzhan 2, Tomb 5. View from the south-east showing the layout of the two bodies and the rich grave offerings (after Čugunov et al. 2010, fig. 36). Reproduced with permission from Parzinger 2017.

The Early Iron Age gold objects from Arzhan 2 (Tomb 5) include jewelry, costume components, ornamental fittings, and a miniature vessel, as well as ostentatious weapons with accoutrements dating from between the late 7th and early 6th centuries BCE. To their ancient wearers and users, they no doubt represented potent signs of prestige, power, and status. Of particular interest is the remarkably wide spectrum of stylistic variations, symbolic content, functional groups, and technological processes displayed by this unrivaled assemblage of early equestrian nomadic material culture. Mostly designed in the Early Scytho–Siberian animal style, the objects also testify to an appreciation of fauna, with astonishing attention paid to the details of anatomical renderings.

Even before this discovery, the Scythians were famed for their work with precious metals. The gold of the equestrian nomads has become known worldwide through many international exhibitions, focusing, for instance, on the important Siberian Collection of the State Hermitage in Saint Petersburg (Rudenko 1962; Korolkova 2017) and on the finds from the North Pontic region, held in museums in Ukraine and elsewhere (among many others, see Alexeyev 2012; Antonini 1998; Aruz et al. 2000; Meyer 2013; Schiltz 1994; Simpson and Pankova 2017b). While the animal style is a defining feature of Scythian goldsmithing in general, its morphological and iconographical characteristics underwent regionally specific changes over time, as did the preference for specific media and the technological processes applied in the production of objects (Aruz et al. 2000; Jettmar 1979; Kossack 1980; Schiltz 1994, pp. 3–81). Unfortunately, most Scythian gold objects from Siberia came to light under unknown circumstances. The resulting lack of contextual information impedes their reliable classification and interpretation. Furthermore, the extensive literature on Scythian gold focuses mainly on spectacular objects and their stylistic qualities. Craftsmanship and technical details have rarely received consideration, and the tools and techniques used in their production have often been presented from the perspective of modern craft practices (Franchi and Bonora 2005; Minasjan 1998, 2004, 2014).

Employing modern field methods, the excavations at Arzhan 2 produced detailed documentation that opened up previously unimaginable possibilities for interdisciplinary research (Čugunov et al. 2010). Meanwhile, the site's exceptional finds and state of preservation played an equally significant role in the subsequent direction of research. Most previous excavations of Scythian elite tombs revealed that the sites had been either partly or completely looted by grave robbers.

This article addresses key aspects of the manufacturing processes that are identifiable in the collection of precious metalwork from the Early Scythian princely tomb of Arzhan 2. The investigation harnesses an interdisciplinary approach that combines archaeological, stylistic, and technical observations with experience from experimental archaeology, ethnoarchaeology, and metallurgy, as well as information from ancient textual and pictorial sources (Armbruster 2014; Armbruster and Guerra 2003). The methodological lens draws on the socio-anthropological concept of the *chaîne opératoire* (operational sequence) in order to explore the technological processes through which raw materials (in our case, most likely native gold from the Altai) were converted into cultural products. This framework considers technological analysis as an objective in its own right, separate from stylistic and cultural interpretation (Leroi-Gourhan 1993; Lemonnier 1992). Accordingly, our investigation principally focused on toolmark analysis and the visual examination of objects' original surface topography through macro- and microscopy. While such toolmarks cannot reveal complete operational sequences from creation to deposition, they provide empirical evidence of specific technological choices involved in the production process (Sillar and Tite 2000). The aim of this article is to identify technological choices that offer insights into manufacturing techniques, and the tools and materials on which they drew.

From an artistic and artisanal perspective, the goldwork from Arzhan 2 is unusually versatile, allowing for the identification of several distinct find groups based on purely technical grounds (Armbruster 2007, 2009, 2010). The stylistic, morphological, functional, and technological features of the Scythian goldwork from Arzhan 2 exhibit local traits, as we will see. Only a few comparable pieces are known to date, among them, single

pieces from Kazakhstan or Pakistan (Popescu et al. 1998; Rahman 1990). The Siberian Gold collection mentioned above (Rudenko 1962; Korolkova 2017) includes some broadly comparable pieces, but sadly lacks sufficient archaeological documentation to serve as a point of reference for the development of stylistic classifications and chronologies. Apart from a few barely decorated items, objects worked in a local variation of the animal style are predominant in the assemblage from Arzhan. Beyond the general parallels in the rendering of certain animals that define the Iron Age art of the Eurasian Steppe as a “Scytho–Siberian” stylistic koine (notably, the perched rams, “tiptoeing” stags, and curled felines), this idiom has, to date, no close parallels among similarly early material, and clearly goes back to the local Bronze Age traditions of the Altai-Sayan region, familiar from bronze knives and daggers, rock carvings, and tattoos (Cunliffe 2019, pp. 85–103). Spiral ornamentation with spiral hooks, stylized flame or wing representations, fish bladders, and floral motifs are less frequently shown. Most likely, the zoomorphic and highly stylized or abstract motifs convey symbolic meaning through a set of codes no longer accessible to us. Anthropomorphic representation does not occur in this Early Scythian goldsmith art. In later works from the 5th century BCE onward, figural depictions of communal life reflect the social world of the Scythians (Alexeyev 2012; Meyer 2013; Schiltz 1994; Simpson and Pankova 2017b). This later tradition of Scythian metalwork from the North Pontic region, famous from spectacular toreutic masterpieces (Mantsevich 1987; Rolle 1998; Bidzilya and Polin 2012; Babenko 2023), speaks to a distinct context of cultural interaction with Greek settlers on the Black Sea shore. Greek and, indeed, West Asian influences are unknown in the eastern Eurasian Steppe, and even at its western end, appear only in the 5th century BCE. Furthermore, goldwork from this early period is generally rare in the northern Pontic region. All in all, the combination of different object types, stylistic interpretations, and technical preferences found in Tomb 5 of Arzhan 2 is unique and exceptionally appealing.

Due to the abundance of finds, the following discussion can concentrate only on a representative selection of case studies. In order to gain a better understanding of the overall range of finds from the site, this article should ideally be read alongside the volume mentioned above (Čugunov et al. 2010). The present discussion will focus first on the diversity of the technical solutions the Scythian goldsmiths employed to produce animal-style goldwork, highlighting the dexterity and ingenuity of the makers. Subsequently, the individual techniques are explained and illustrated, with reference to further examples.

1.1. The Animal Style and Its Technical Implementation at Arzhan

Most of the gold finds from Arzhan 2 are designed and decorated in the Early Scythian animal style. The selection of animal species depicted on the objects—including felines (panthers and tigers), deer, boars, horses, goats, sheep, rams, camels, and birds of prey—is significant in its own right, as it reflects aspects of the region’s animal world and its veneration by the horse-borne nomads. Moreover, it is remarkable to see the artisanal repertoire that was employed to render the various animals in gold and the range of processes that was brought to bear selectively in accordance with the form, function, and aesthetics of a given piece of jewelry. These considerations come to the fore in the two-dimensional representations, whose shapes are determined by the silhouette specific to each type of animal and even more clearly in the animal forms rendered in bas-relief, half-relief, and three-dimensional figurines. Polychrome effects were achieved either through color accents, such as enamel overlays, or through sketch-like drawings finished with metal inlays. Other items show a two-tone effect accomplished with the help of openwork or appliqués in reflective metals that create a contrast with the material of the background, such as leather, fabric, or the like.

Animals depicted in two dimensions are exemplified by the thin decorative plaques in the forms of crouching horses that were attached to the headdresses of the two deceased with the help of eyelets attached to the back. The items from the costumes of the man and woman were executed in a slightly different manner (Figures 3(1,2) and 4(1,2)). The plaques’ outlines were shaped to resemble those of a horse’s body, with the eyes, mouths, nostrils,

and ears of the examples in the male burial rendered with filigree wires and filled with enamel, and the mane highlighted with chiseled lines. The decoration is less elaborate on the plaques from the female burial, with anatomical details indicated solely with chiseled and engraved lines, and the mane indicated with openwork cutouts. On the top of his headdress, the male also wears a stag figure made of flat metal sheets that were assembled to highlight the figure's outline in a manner comparable to that of the horse plaques (Figure 5(1–6)). An interesting detail in this single, upright animal figure is the filigree and enamel work applied to both sides of the head, as well as the antlers made of sheet metal, attached with the help of an additional rivet pin (Figure 5(3,4)). Initially conceived as two-dimensional, the rutting stag nevertheless makes a three-dimensional impression due to its upright and freestanding posture, which allows the applied ornamentation to be visible on both sides, as well as the double antlers of sheet metal. The stag's particular posture, on the tips of its hooves, is also striking—a posture characteristic of the Early Scythian animal style. The stag is physically attached to a cloud-shaped gold sheet plate using flanging, with extensions of the gold-sheet hooves passing through slots in the base plate before being fixed in place on the underside through bending. The plate with the vertically standing stag figure was attached to the top of the headgear with the help of small eyelets (Figure 5(5,6)).



(1)

(2)

Figure 3. (1,2) Horse-shaped plates from the female headdress, made of hammered sheet metal with engraved and openwork decoration, and six small sheet-metal ribbon eyelets on the back. Photos by B. Armbruster.



(1)

(2)

Figure 4. (1) Solder residue on the back of the gold-sheet horse from the man's deposition; (2) front and back of the sheet-metal horses. Photos by B. Armbruster.

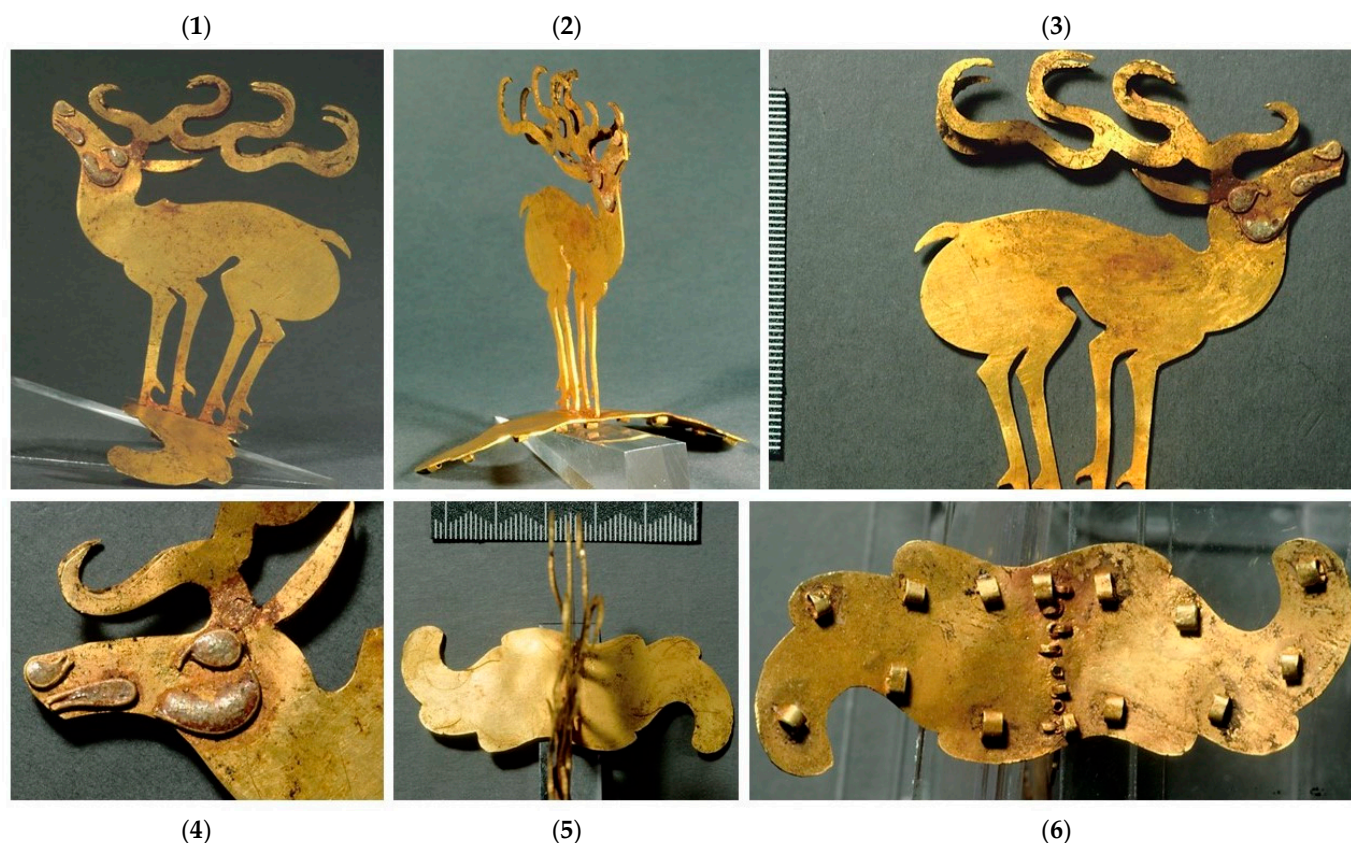

Figure 5. (1–6) Gold-sheet deer figurine; (1,2) upright gold-sheet animal figurine with two deer antlers; (3,4) cellular enamel in filigree and fastening rivet for a second gold-sheet antler bar; (5,6) base of the gold-sheet deer figurine with 14 sheet-metal eyelets on the underside for attachment to the man's headdress and physical connection along the centerline. Photos by B. Armbruster.

Most of the goldwork items from Arzhan show reliefs depicting animals of various dimensions and designs. These were initially worked in chip carving and then cast in gold through the lost-wax process. According to their context of use, such notched reliefs were conceived to accentuate fully three-dimensional or more planar visual effects, and elsewhere were combined with openwork. The technique affords dynamic effects of light and shadow that animate the animals and their figural details in attractive and lively ways.

A case in point is the necklace worn by the woman. It consists of a flat cast gold plate in the shape of a crescent moon with a flat notched relief on its surface and a loop-in-loop chain attached to each end (Figure 6(1–6)). In this case, the elongated animal bodies of panthers, boars, and deer were nested between spiral patterns (Čugunov et al. 2010, pl. 79. 2). The hollow-cast miniature cauldron and the shafts of long needles are further examples of bas-reliefs that were initially shaped through chip carving (Figures 7(1–3) and 8(2)). The decorated surfaces of these works are completely covered with relief decoration, i.e., in *horror vacui*.

The complex animal frieze on the man's massive neck ring is composed of numerous animal bodies (Figure 9(1–6)). It consists of four continuous animal frieze bands that spiral in alternating directions around the round-barred, ring-shaped part. While the neck ring itself is three-dimensional in design, the animals are worked in half-relief (Figure 9(2)). The animal representations include predatory felines, horses, goats, sheep, two-humped camels, wild boars, and a deer (Čugunov et al. 2010, pls. 4 and 35–36).



Figure 6. (1–6) Woman's necklace, notch-cut in bas-relief, perforated ends, loop-in-loop chains. Photos by B. Armbruster.

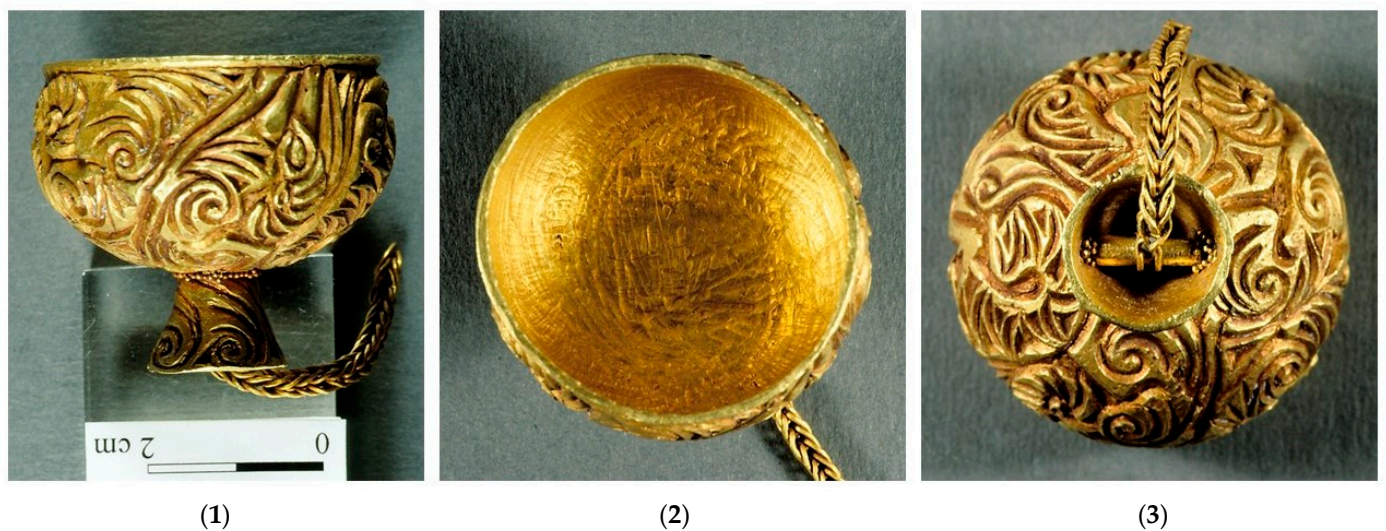
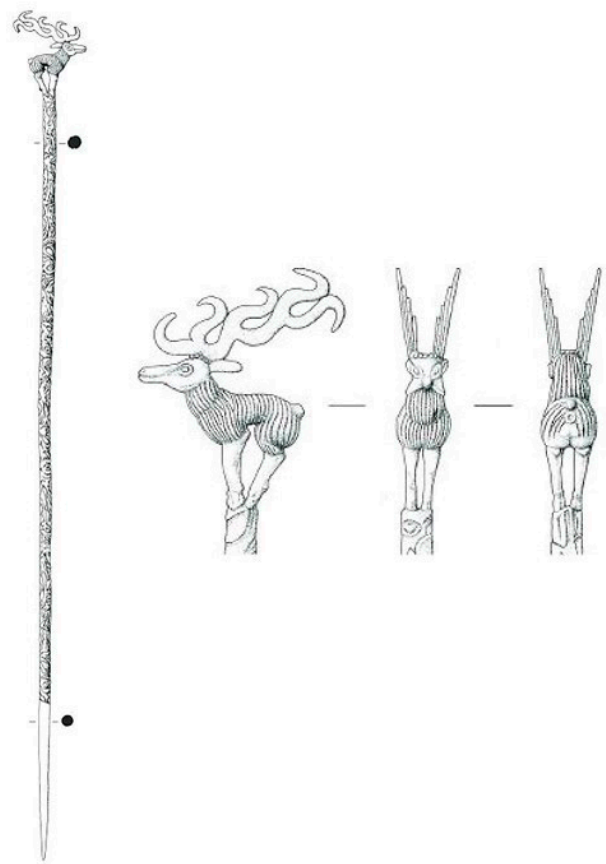

Figure 7. Pendant in the form of a miniature cauldron, hollow cast in the lost-wax process over a core. (1) Notch-cut relief on the outside and granulation line at the transition between the body and the stand; (2) traces of scraping on the inside; (3) suspension inside the cauldron stand consisting of a cross pin and loop-in-loop chain, with granulation decoration. Photos by B. Armbruster.



(1)



(2)

Figure 8. (1) Pinhead with fully sculpted stag. Photo by B. Armbruster; (2) drawing of pin and pinhead (after Čugunov et al. 2010, pl. 56).



(1)

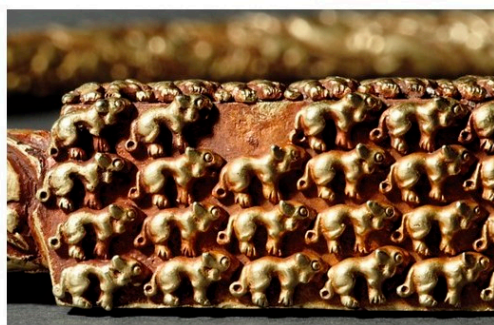

(2)



(3)



(4)



(5)



(6)

Figure 9. (1) Cast, closed, and solid neck ring from the man; (2) front piece with small, soldered panthers (one piece missing); (3–6) the circumferential animal frieze in notch-cut. Photos by B. Armbruster.

The animal frieze was cast together with the front piece using the lost-wax process, wherein the relief was carved into the wax model using the chip technique and then transferred into metal using a mold. After the casting procedure was completed, the surface was finished with punches, chisels, and scrapers. As a comparison piece to this animal frieze, we can point to the fragments of a massive neck ring with a rectangular cross-section, also bearing notch-cut decoration from Pattan, Kohistan in Pakistan (Rahman 1990; Čugunov et al. 2010, p. 312, Figs. 284, 3–7). The front piece of the example from Arzhan has a rectangular cross-section, and was initially left smooth and undecorated during casting. Subsequently, the numerous small panther figurines—unlike the animals on the neck ring, all oriented in the same direction—were cast in a series of individual half-reliefs. Each panther was then soldered separately to the two smooth sides visible from the front to form parallel rows (Figure 9(1)) (Čugunov et al. 2010, pl. 35).

Thousands of appliqués in the forms of small predatory felines, and hundreds in the forms of wild boars, were prepared as semi-reliefs in wax and cast in large series (Figure 10(1–3); see below). The animals are shown in the characteristic “tiptoe” posture mentioned above and in a side view that accentuates the recognizable silhouette of the two animal species (Čugunov et al. 2010, pls. 37, 38, 44). It is worth nothing that, despite their small dimensions, the appliqués are provided with anatomical details, such as eyes, mouths, ears, tails, and paws or hooves. The backs are slightly concave, most likely to reduce the weight of the individual pieces, which would have been a necessary measure considering that the sheer weight of over 2500 cast animal figures sewn to the male outfit would have added up to a substantial quantity of gold.

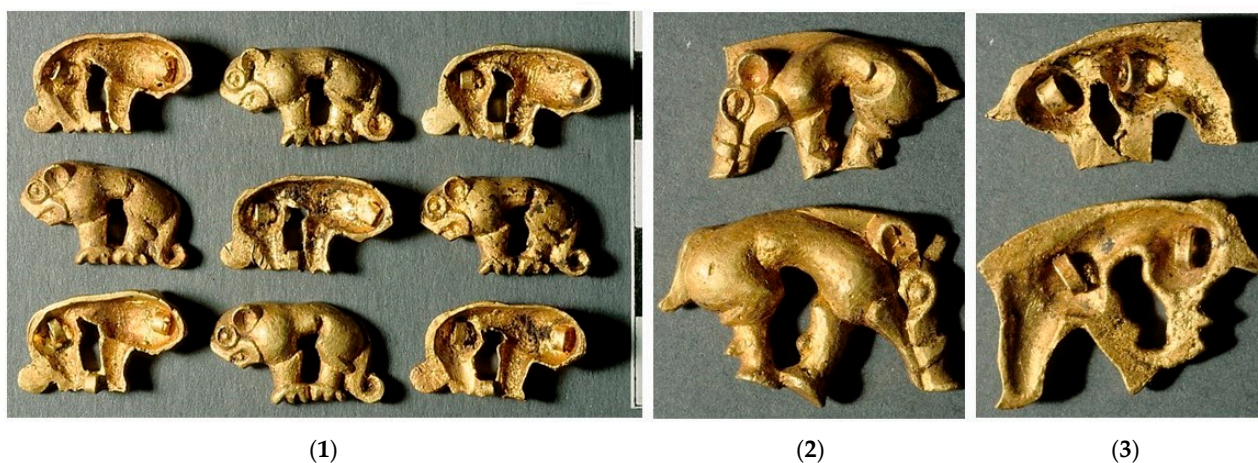

Figure 10. Series-cast animal figurines, the fronts in semi-sculptural relief, the backs hollow and with soldered eyelets bent from sheet-metal strips; (1) panther; (2,3) boar. Photos by B. Armbruster.

An example of a three-dimensional conception of the animal style is the long pin found with the female body, which was decorated with a freestanding deer figure tiptoeing on its hooves (Figure 8(1)) (Čugunov et al. 2010, pls. 74. 2a–e and 52. 1). As with the previous examples we looked at, this figurine was carved in a wax model and then cast in the lost-wax process. Only the double-sheet gold antlers were made separately and attached by soldering. The small, crouching ram figures, on the other hand, were cast in a mixed method, combining half-relief at the body and full-relief at the neck and head (Figure 11(1,2)) (Čugunov et al. 2010, pls. 62. 3–7 and 78. 4–5). The figures were provided with a semicircular bent sheet at the base and served as sliders on the woman’s dagger belt.

In addition to these items, numerous strap elements and belt accessories cast in gold are decorated with animal forms in notched relief. Among them are stylized variants, such as an impressive omega-shaped clasp with two heads of birds of prey—probably eagles—facing away from each other (Figure 12(1–5)). Although a solid cast object, it is provided with openings. The front was heavily reworked, as is evident from the tool marks

left by a scraper in and around the large loop and on the notch relief of the bird heads. The surfaces on the reverse and on the relief of the fasteners, by contrast, still show the raw finish of the casting skin, which was, in this instance, very rough.



Figure 11. (1,2) Small sliders with hybrid (half-relief and in the round) ram figures and sheet metal. Photos by B. Armbruster.



Figure 12. Omega-shaped fastener with two birds of prey heads. (1,4) Front side with distinct traces of having been worked over with a scraper and grinder; (2,3,5) back side with cast skin clearly visible. Photos by B. Armbruster.

The decoration on the pommel and guard of the man's dagger consists of four curled tigers (or other predatory felines) arranged in opposing pairs. The animals are clearly recognizable thanks to the visual effect of the inlaid gold wires (Figure 13(1–4)). Numerous highly stylized, smaller animal bodies adorn other areas of the handle as well as the

central ridge of the blade. Additional gold inlays were added to the lateral parts of the dagger handle's circumference. From a technical standpoint, this inlay work is particularly noteworthy, as it extends over the rounded surfaces of the relief as well as the flat areas of the blade. On other objects, such as iron arrowheads, the application of gold inlay is also impressive, with its finely executed figural designs (Čugunov et al. 2010, p. 47, pl. 46. 1). One large triangular arrowhead, for example, shows figure work—a goat's head and a bird of prey with its head and claws turned back—in black reserve, while large areas in the background are evenly covered in gold (Figure 14(1,2)).



Figure 13. (1) Iron weapons with inlay decoration, the men's dagger and two ring handled knives; (2–4) details of the dagger with linear (tiger) and flat (blade) inlays; (5) small gold pieces from inlays. Photos by B. Armbruster.



Figure 14. (1,2) Iron arrowhead with gold inlay; detail of the arrowhead. Photos by B. Armbruster.

The outlines of the animal bodies derive their special charm from the contrast between the light background and the dark figures, with their interior details demarcated with gold lines. The scene represents the predator tearing its prey into pieces. While decorated

arrowheads are known from other sites in the Scythian world, it is extremely rare that they are decorated with extended figural groups conceived in a coherent artistic idiom (Alexeyev 2012, pp. 60–61).

1.2. Functional Groups

From a functional point of view, the personal adornments and costume components associated with the female and male buried in Arzhan 2 (Tomb 5) should be distinguished from the ornamental elements made for the weaponry and wooden vessel. Modern reconstruction drawings and exhibition mannequins wearing replicas of the clothing, footwear, headgear, jewelry, and weapons offer an impression of the splendor that the personal equipment of the couple from Arzhan once afforded (see Čugunov et al. 2006; Čugunov et al. 2010, plates 1–81; Stepanova and Pankova 2017, p. 93, Fig. 75).

The personal adornments include pieces that were worn directly on the body, such as necklaces and earrings (Figure 15(1–7)). The finds consist mostly of unique items; only one jewelry set was made to be worn as a matching pair. The costume components comprise some custom-made items that were worn as unique pieces—among them, pins, a pendant in the form of a miniature cauldron with a loop-in-loop necklace (Figure 7(1,3)), and the singular elements of the headgear, such as the man’s stag figure mentioned above (Figure 5) and the woman’s chiseled panther appliqué (Figure 16(1,2)). Other items were made as pairs. These consisted mostly of earrings, band-shaped trimmings employed as boot ornaments, and horse-shaped decorative plates attached to the headgear. Small appliqués in the form of feline predators—probably panthers—were produced in large quantities and sewn to the cloaks or mantles of the two buried individuals. Among these appliqués, we can distinguish two series that were stylistically related but manufactured in different ways.



Figure 15. Pair of female earrings; (1) tunnel earplugs with granulation, filigree, and enamel; and suspended filigree-decorated rings and link chain; (2) filigree ring with conical extension; (3) enamel cells with granulation; (4) triangular granulation and enamel surrounded by twisted wire; (5) perforations at the base of the conical extension for attaching pendant strands of beads; (6,7) filigree work of the complex rings. Photos by B. Armbruster.

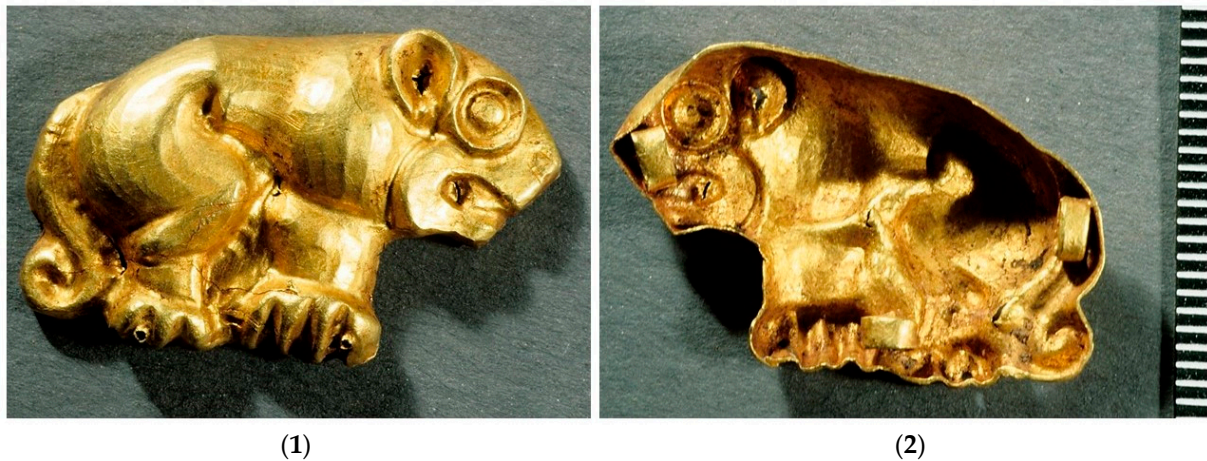

Figure 16. Panther emblem chased from thin sheet metal. (1) Front side with clear chasing traces of the punch and two perforations on the claws; (2) hollow back side with three soldered sheet-metal eyelets for mounting. Photos by B. Armbruster.

The man's 2632 small animal appliques were made from the same casting mold, while the woman's 2297 identically shaped panther figurines were struck from thin gold sheet using a die or punch (Figures 17 and 18(1–3)). As a result, these strikingly similar variants of appliques differed significantly in weight. Both variants were provided with small sheet-metal eyelets that were soldered to the back and sewn to the fabric or leather of the cloak in curvilinear patterns (Čugunov et al. 2010, p. 29, Fig. 37, pp. 34–35, Figs. 44–45). A less plentiful but significant series of 312 boar appliques was cast in two different sizes and served to decorate the wooden lining of the quiver (Figure 10(2,3)).



Figure 17. Cast appliques in the shapes of predatory felines from the male in the burial. Photo by B. Armbruster.



Figure 18. (1) Small figurines of a predatory felines from the woman, made of thin sheet metal through pressing into a die; (2) front sides; (3) back sides with eyelets. Photos by B. Armbruster.

Other clothing and shoe trimmings consisted of countless sewn-on miniature beads, which are estimated to number around 25,000 pieces for the man's garment alone. Measuring only about one millimeter in size, the beads covered the man's trousers, the hem of the woman's skirt, and parts of her shoes (Čugunov et al. 2010, pl. 34. 2–7). The miniature beads attest to a range of production techniques, having been cast or formed as open or closed shapes in sheet metal (Figure 19(1,2)).



Figure 19. Miniature beads, (1) cast and (2) sheet metal. Photos by B. Armbruster.

Among the weapons decorated with gold are a battle axe (Figure 20(1–4)), two daggers (Figures 13(1–4) and 21(1–5)), two ring knives (Figure 13(1)), and several iron arrowheads

with gold and silver inlays (Figure 14(1,2)). The woman's iron dagger consists of a blade with gold inlays and an openwork cast gold handle attached by a rivet. The inlaid patterns of the iron weapons are formed in combinations of abstract spiral or flame motifs, as well as zoomorphic images.

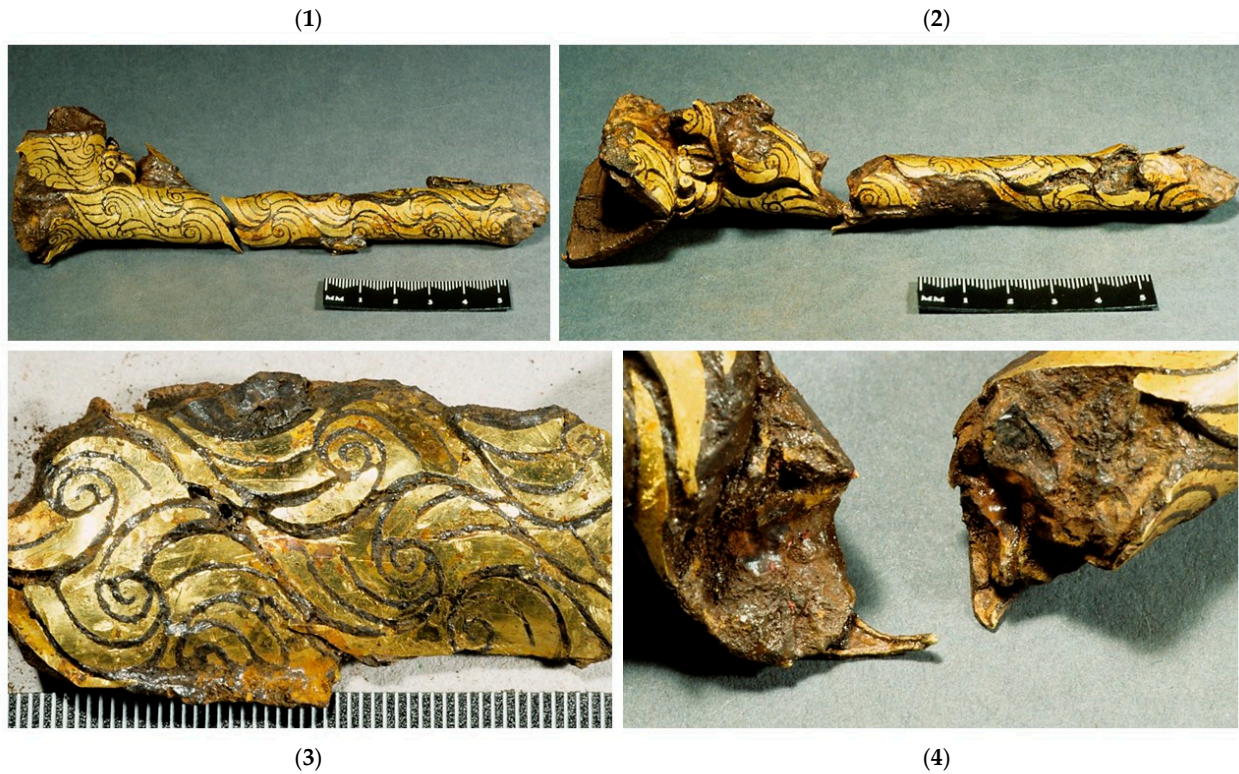

Figure 20. (1,2) Two views of the fragmentary battle axe; (3) details of the inlay decoration and (4) a view of the back of an inlay element. Photos by B. Armbruster.

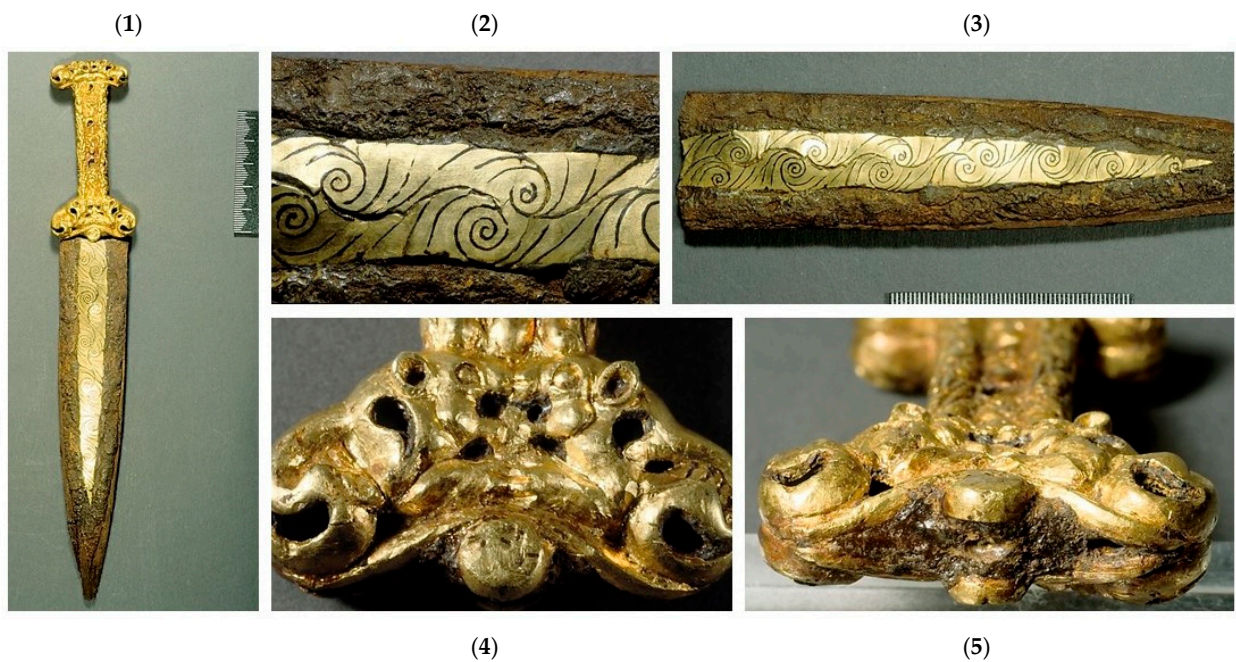

Figure 21. (1) Iron dagger blade found with the deceased woman; (2,3) details of the gold surface inlay; (4,5) two views of the rivet pin and remnants of the blade attached to the gold dagger handle with it. Photos by B. Armbruster.

The gold elements from the weapons include the items that adorned the quiver's carrying strap, among them, numerous hollow-cast sliders, strap tongues, and end elements, as well as locking pieces (Figure 22(1,2)). Other items consist of thin-walled cylindrical sleeves and gold-sheet fittings for a bow and a whip handle made of organic materials that have disintegrated (Figure 23) (Čugunov et al. 2010, pls. 45 and 50).



Figure 22. (1,2) Cast belt trim, sliders, and finials. Photos by B. Armbruster.



Figure 23. Elements of a whip, hollow-cast end pieces, and open cylindrical sheet-metal sleeves. Photo by B. Armbruster.

These decorative elements are often designed to create a two-tone effect with the color of the base material, such as leather or wood. Among them are both heavy pieces of strap decoration that were cast with details in openwork and light fittings made of thin sheet metal, including the decorative elements of the bow. The bow was also decorated with gold-wire elements.

As an example of an object made of wood and covered with pressed-relief sheet metal, we can highlight a vessel with a handle covered in a decorative gold sheet in the shape of a hoof (Figure 24(1–4)) (Čugunov et al. 2010, pl. 81. 1). The finds featured a wooden comb with a gold-plate handle and a bronze mirror with gold slides

(Čugunov et al. 2010, pl. 80. 1, 4). The ingenuity and material investment expended in enhancing the numerous objects from the princely tomb with gold—be they made of bronze, iron, or organic materials—demonstrate the exceptionally high esteem in which the buried couple was no doubt held.

The ways in which Early Scythian goldsmiths were able to combine different materials, stylistic expressions, and technical solutions foreground their dexterity as craftspeople, their capacity as designers, and their deep understanding of their materials.

Only a few pieces show clear signs of wear, among them the man's massive neck ring. The pristine condition of most other items indicates that most of the goldsmiths' works were never, or only extremely rarely, worn in everyday life. As a result, it seems likely that the goldsmiths made most items shortly before the burial as grave offerings for display in the funerary ritual.

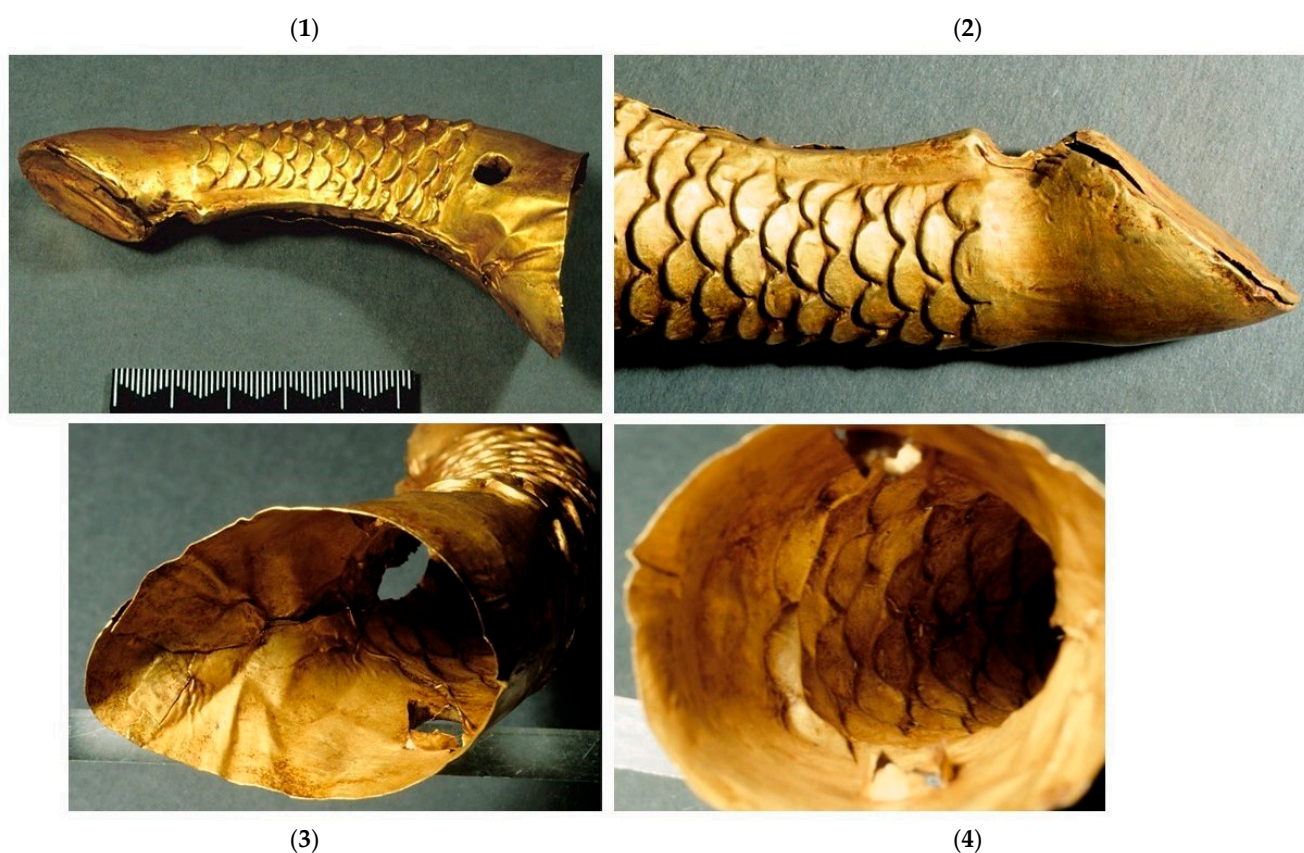

Figure 24. Pressed gold-sheet decoration of a wooden bowl handle; the scale-like relief was carved into the wooden handle. (1,2) Exterior of the hoof, relief, and rivet hole; (3,4) view of the interior showing the negative relief. Photos by B. Armbruster.

2. The Goldsmiths' Techniques

Several craft traditions are discernible in the precious metalwork, suggesting either that the collection represents the output of several workshops or that one workshop was able to accommodate this diversity, both technically and stylistically. At least five main areas of artisanal specialization can be identified: cast products with notched or chip-carved decoration; simple sheet-metal products; pressed sheet-metal work; objects with granulation, filigree, or enamel; and precious metal inlays in iron.

Many pieces were made using a combination of several techniques executed in an operational sequence determined by the requirements of each technological action. On complex pieces, the decoration drew on multiple technological principles. The miniature cauldron, for instance, is primarily characterized by its exterior relief that was first carved, and then cast and reworked. Closer inspection, however, also reveals that the object bears

discreet granulated decoration in two areas, as well as wirework in the form of a loop-in-loop chain attached to the vessel's foot (Figure 7(1–3)). Another example is the long decorative pin with a cast ornamental relief around the shaft and a bowl-shaped pinhead at its end (Figure 25(1)). Furthermore, an openwork decorative plate and a row of granulation were soldered to the shaft just below the pinhead.



Figure 25. (1) Line granulation at the head of a long needle; (2) scatter granulation at the chain suspension of the miniature vessel. Photos by B. Armbruster.

Of particular interest is the manufacture of substantial quantities of feline figurines of the same type. This mass production of thousands of animal figurines or even miniature beads requires an appropriate workshop organization to economize labor time. Measures to limit the amount of precious material used are evident only in the pressed sheet appliques produced for the woman's garment.

In the following discussion, we investigate the goldsmithing techniques, tools used, and operational sequences of technological actions with reference to the finds from Arzhan 2. Case studies are used to illustrate the salient identifying features of each technique.

To date, no analytical results of alloy compositions represented in the gold from Arzhan have been published. It is presumably native gold with small amounts of silver and even smaller quantities of copper. The goldsmiths were certainly familiar with the principles of intentional alloying, since the solder on several items relied on the admixture of some copper to lower the metal's melting point.

2.1. Casting Process

The production sequence of all gold objects is based on an initial cast item. In some instances, this preliminary product already featured the object's shape and relief decoration. Elsewhere, the initial element consisted of an ingot that the goldsmith transformed into wire or sheet metal through hammering.

Ingot casting: Ingot casting was used to produce the preliminary elements, which were then formed into plates, sheets, rods, or wires through plastic deformation. Molds made of solid materials, such as clay, stone, or bronze, can be used to make ingots. The simplest option, however, is to pour the molten metal from the crucible into a sand pit in the workshop floor or into a piece of charcoal with an appropriately shaped depression carved into its surface (Armbruster 2001).

Lost-wax casting: The vast majority of the gold finds from Arzhan were cast by means of the lost-wax method. The procedure is particularly suitable for casting complex reliefs, as well as hollow or solid three-dimensional forms. The objects decorated with relief were first modeled in wax, and then the decorative details were carved. The small animal figures

with a cavity at the back also belong to this category of cast products (Figures 10(1,2) and 17) (Armbruster 1993; Hunt 1980; Fröhlich 1981). Most of the cast pieces, regardless of whether they bear notched decoration or not, show traces of scraping and cutting resulting from the removal of the rough casting surface on the visible parts of the object, whereas the backs often show clearly identifiable remnants of the rough casting skin (Figure 26(1,2)).



Figure 26. (1,2) Strap end with notched relief in animal style, distinct rough cast skin on the reverse side. Photos by B. Armbruster.

In the lost-wax casting process (Figure 27), the wax model is shaped precisely in the form of the desired object (Hunt 1980; Sias 2005). This can be done by modeling, removing material through carving (i.e., subtractively), or adding or assembling elements using liquefied wax (i.e., additively). The finished model is then provided with casting channels and a casting funnel made of wax. In a subsequent stage, the complete wax model, except for the end of the casting funnel, is encased in several layers of refractory clay with very few organic inclusions. Enriched with charcoal powder and finely ground clay, the first layer can be applied as a liquid solution resembling a slip in order to reproduce the model's decoration or relief in all its details. Before a new layer of clay is applied, the previous one must be allowed to dry completely.

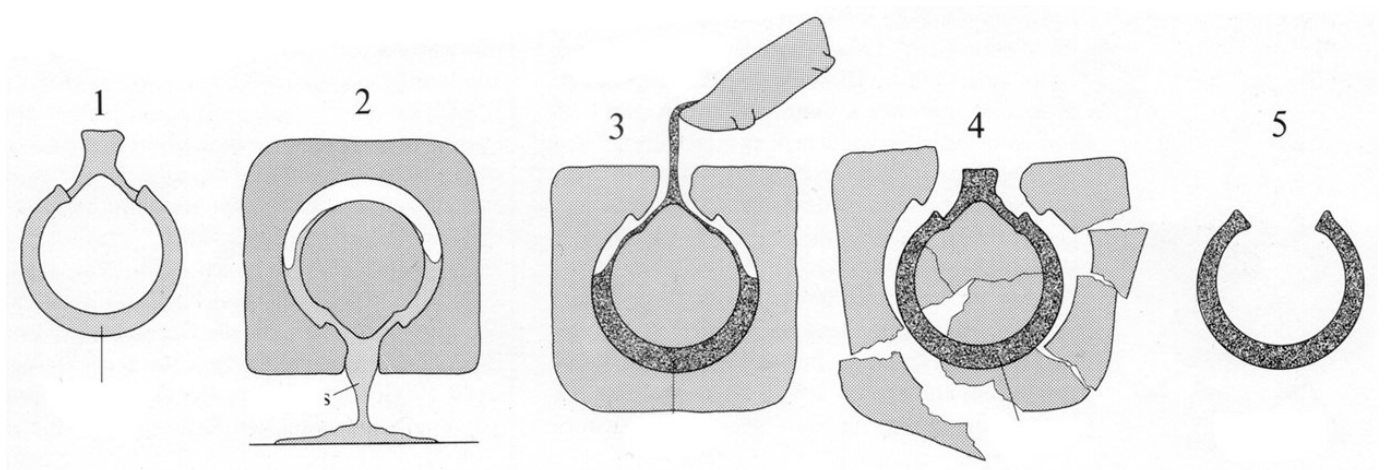

Figure 27. Schematic drawings of the lost-wax casting process. (1) Wax model with casting channels and casting funnel; (2) clay investment (casting mold) and removal of melted wax after drying; (3) filling of the remaining cavity with molten metal; (4) breaking of the clay mold jacket after cooling; (5) raw cast product after the removal of channels and casting funnel (after Wübbenhorst and Engels 1989, p. 14, Fig. 7).

After the mold has dried out completely, it is heated until the melted wax can be poured out. The resulting cavity is then filled with molten metal until the casting funnel overflows. After cooling, the clay mold is destroyed and all clay residue removed; the casting channels are then cut off and the surface of the raw cast is worked over. Since the clay of the casting mold is tempered with organic materials (such as animal dung) to prevent shrinkage cracks, any gases that might form while the molten metal is poured can escape through the cavities left by the organic matter removed through the firing process. The lost-wax casting method transfers all details directly into the metal object. As a rule, however, a rough casting skin forms on the surface of the object, as can be clearly observed on many objects made in Arzhan. Such traces are removed either by abrasion (scraping, grinding, or polishing), densification (chasing), or chiseling. On the casts from Arzhan, however, remnants of the casting skin are not always visible in the notch cuts, which speaks to the extraordinary care expended on the finishing process. Owing to the complex shapes of the finished products, it is nevertheless possible to conclude that these objects were produced through the lost-wax technique.

Lost-wax process with casting core or openwork: Hollow objects, such as the miniature cauldron (Figure 7(1–3)), the two end pieces of the whip handle (Figure 23), and numerous elements of the belt decorations (Figures 28(1–4) and 29(1–3)), were cast over a core. The casting core, like the casting mold shell, was probably also made of clay containing little organic matter. To achieve the open cavity, the wax pattern is modeled over the dried clay core and then encased with the clay investment of the mold. Core supports become necessary when the core is completely covered by the wax model. To add such supports, metal pins are inserted through the wax pattern so that the clay core and outer clay investment are connected. They serve to hold the core in place after the wax has been melted out, allowing the molten metal to fill the cavity between the core and the mantle. This hollow casting technique enables not only the production of a great variety of object shapes, but also the efficient use of metal.



Figure 28. (1–4) Hollow-cast sliders with relief outside and casting skin inside. Photos by B. Armbruster.



Figure 29. (1–3) Hollow-work and openwork cast sliders with notched decoration. Photos by B. Armbruster.

Serial casting: For the small animal figures that occur in very large numbers, such as panthers and boars, which were cast with slightly hollowed backs, it is likely that they were not produced individually but rather in multiples in a complex lost-wax casting process. In this process, several individual wax models are attached to a so-called “wax tree” (Autorengruppe TAG 2016; Franchi and Bonora 2005, p. 54; Untracht 1987, p. 543, Figs. 11–83). This construction consists of a central “trunk” and numerous fine “branches” of wax, to the ends of which the small wax figures are attached with liquid wax (Figure 30).

The identical wax models can be produced in series beforehand by impressing a solid model of the respective animal figurine in moist clay. This can be done several times on one slab of clay to facilitate the work. After the open clay mold has dried, the impressions can be filled with wax. Another possible procedure involves stone or wooden molds from which the negative form of the animal figure has been carved out. These open negative molds can also be filled with wax to create wax figurines in large numbers. To create the back cavities, the mold can be inverted before the wax solidifies completely, allowing some wax to drip off (Figure 10(1–3)).

Finishing the cast objects: The casts are freed from the casting channels or separated from the casting tree by knocking them off with a chisel and hammer. The cast products usually have a rough surface, the so-called “casting skin.” Therefore, after casting, the cast surface is finished by grinding and polishing with grinding stones and polishing agents, scraping and chasing with the help of punches and chisels.

The omega-shaped fastener from the quiver’s sling with bird-of-prey heads provides an illustrative example of the cast skin, still unmistakably visible on the reverse and even in the notch relief of the decorative heads on the obverse (Figure 12(2,3,5)). The item, however, also quite clearly shows the scraping and grinding marks on the front of the decoration (Figure 12(1,4)).

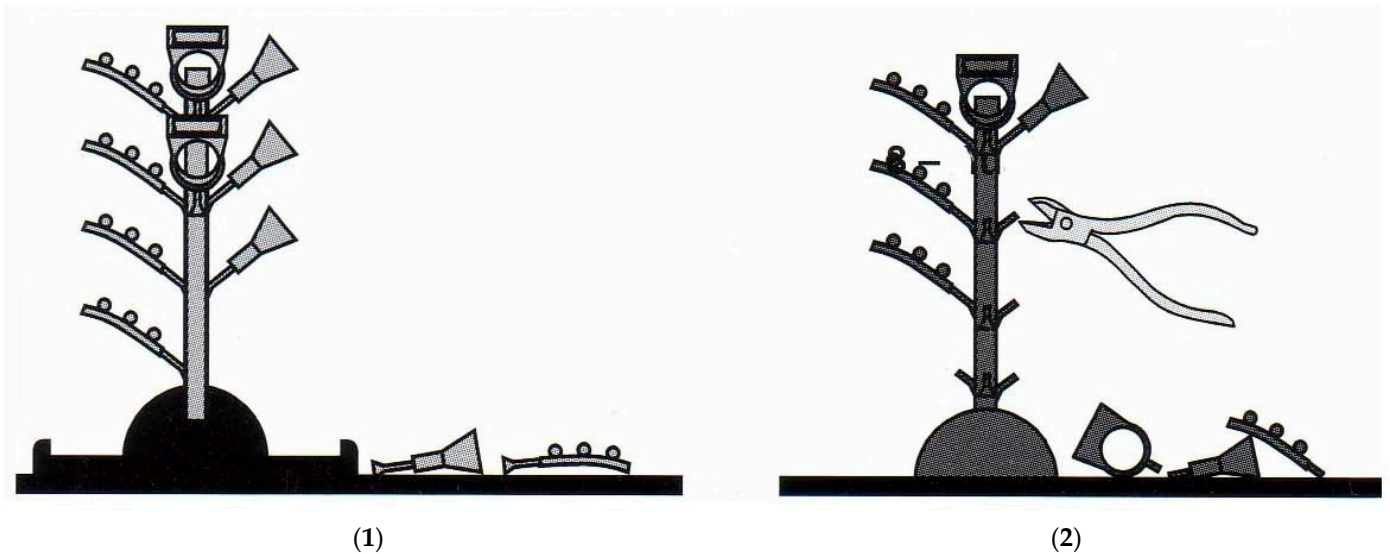

Figure 30. Schematic drawing of a modern casting tree. (1) Wax tree; (2) metal tree after casting process with objects on branches being clipped off (after [Autorengruppe TAG 2016](#)).

2.2. Plastic Deformation Techniques

In order to study the techniques of plastic deformation attested by the finds from Arzhan 2, we turn to the preliminary and final products made of plates, sheets, and rods that were shaped through twisting, bending, chasing, and hammering or repoussé.

Through the process of shaping precious alloys, the cross-section or thickness of the metal is changed, while the volume and weight remain the same. Therefore, the initial and final products of the crafting sequence, which usually begins with an ingot precursor, have the same weight, since no material is lost. Some methods of plastic processing—notably, hammering, twisting, bending, and chasing—render the material hard and brittle. This effect can be counteracted through intermediate stages of annealing. This procedure requires a workpiece of gold to be heated periodically in a charcoal kiln and then cooled once it has reached a red-hot state before the plastic deformation can proceed. The experienced goldsmith must, therefore, know exactly the point at which annealing becomes necessary; otherwise, cracks or fractures may occur. This would render the piece unfit for purpose.

Plates and sheets: As preliminary or final products, gold-sheet works are made by manual forging with hammer and anvil (Figure 31). The striking tools may have been made of stone, bronze, or iron. Furthermore, deer antler, bone, and hardwood implements may also have been used.

The sheet-metal work from Arzhan 2 is of supreme craftsmanship. The uniform thickness of materials in the individual pieces is remarkable, as is the corresponding evenness of smooth surfaces, such as on the man's boot fittings (Figure 32(1,2)). This high degree of accuracy led Chugunov to surmise that rolling mills were already in use by the Early Scythian period. Our study of the materials led us to conclude, however, that the evenness is due to the remarkable artisanal abilities of the Scythian goldsmiths, rather than the use of rolling mills. Sheet metal was also employed to make the countless tiny beads and small sheet-metal band eyelets, which were bent from a section of appropriately shaped sheet metal and then soldered to the ornamental elements, such as the figurines of predatory felines or the horses of gold sheet (Figures 3(2), 4(1,2), 5(6), 10(1,3), 16(2), 17, and 18(2)).

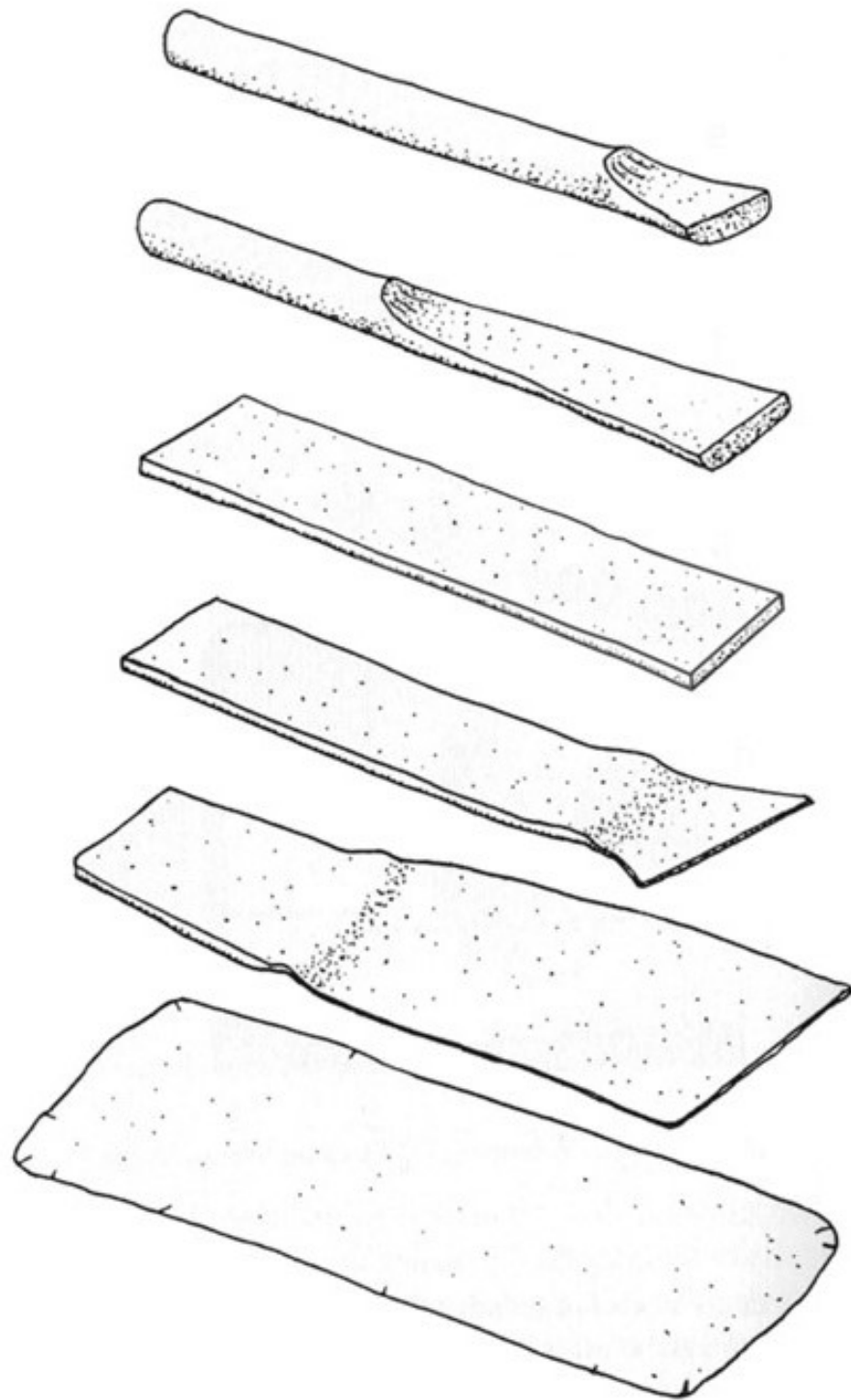

Figure 31. Working steps in the plastic deformation of a cast ingot into a sheet (after Nicolini 1990, pl. 217, e–j).

Whereas the flat metal figures in the shapes of specific animal silhouettes were chiseled from gold sheet (Figures 3(1,2), 4(1,2) and 5(1–6)), other sheets were cut out in rectangles and formed into tubular sleeves. Still others served as preliminary products for more complex objects, such as the woman’s decorative bands (Figure 33(1–4)), or for pressed sheet-metal work (e.g., Figures 18(1–3) and 24(1–4)).



(1)

(2)

Figure 32. (1,2) Boot fitting from the man's body made of smooth, undecorated sheet metal, with a contour of a stylized cloud or wing and perforated ends. Photos by B. Armbruster.

(1)

(2)



(3)

(4)

Figure 33. (1–4) Ornamental bands from the woman's boots showing surface granulation, filigree, enamel, and perforated ends. Photos by B. Armbruster.

Chasing of sheet metal and of casts: Chasing is the technique of shaping metal or adding relief decoration by applying indirect percussion with a hammer and punch to sheet metal resting on a resilient impact pad (Corwin 2010; Steins 2001). No material is removed during the process. The sheet is usually attached to a support by some elastic compound or putty, also known as chasing pitch. For shallow reliefs, softwood or thick leather may also serve as a striking base. The punches can be made of bronze, iron, hardwood, or deer antler (Armbruster 2003b). These pin-shaped tools have a prepared working end that can be blade-shaped, spherical, flat, domed, or hollow, or have an ornamental pattern in relief

(Figure 34). The other end is shaped to receive the hammer blow and indirectly transfer the impact energy to the sheet metal (Figure 35). In the process, the sheet is driven into the putty, creating a relief through plastic deformation. The material thickness of the metal sheet changes according to the degree of deformation through stretching or compression.

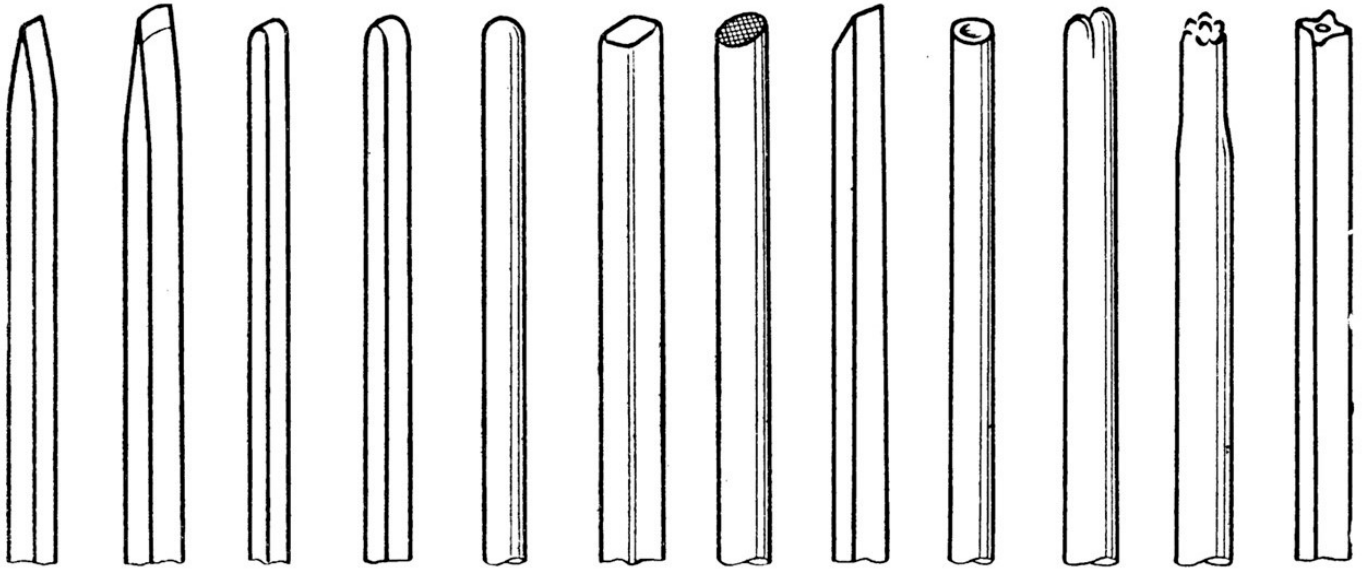

Figure 34. Schematic representation of various chasing punches (Brepohl 1980, p. 230, Fig. 191).

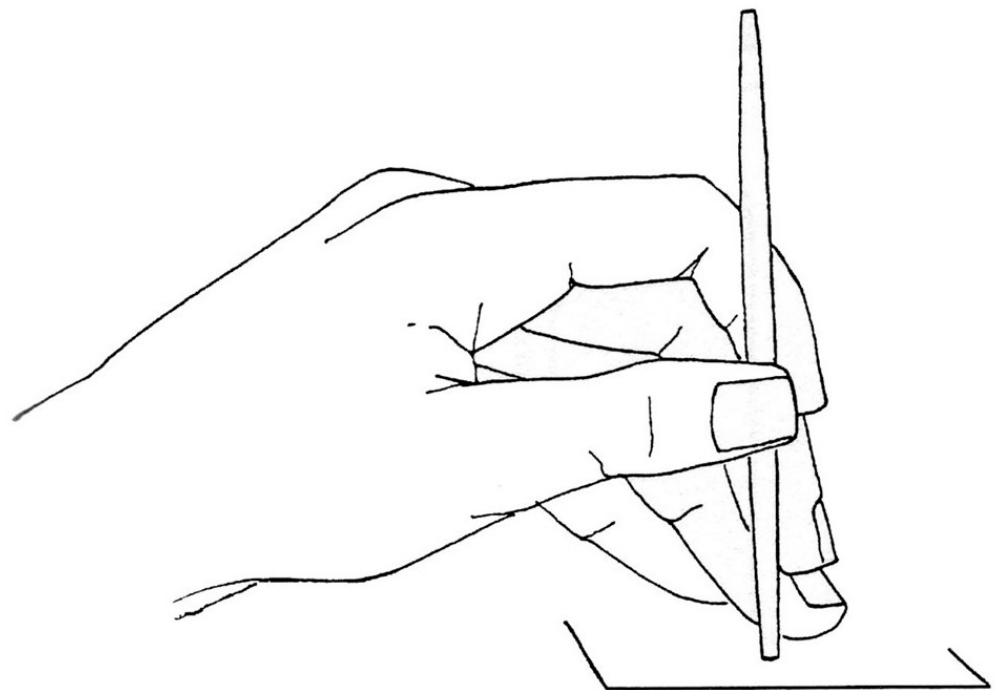

Figure 35. Handling of a punch driven into the sheet surface with a percussion instrument (Fröhlich and Fröhlich 1974, p. 44).

Among the finds from Arzhan 2, the use of sheet-metal chasing is clearly identifiable as a technique for both shaping and decorating objects on only one item: the single panther emblem on the woman's headdress (Figure 16(1,2)). Chasing, however, also served as a decorative technique and for finishing the surfaces on the numerous pressed sheet-metal works in the form of identical figurines of small predatory felines (e.g., Figure 18(2)).

In cast objects, chasing can also be used for finishing—as opposed to shaping—surfaces with punches. In this process, the principle of plastic deformation, with the aid of a punch and hammer, is employed to compact and smooth the uneven areas of the cast surface. The notch-cut works from Arzhan were therefore reworked not only through cutting techniques, such as scraping, chiseling, and engraving, but also through deformation with punches.

Pressed sheet work with dies and serial production: The working of sheet metal with dies and decorative punches or stamps is generally used for the serial production of a considerable number of identical sheet-metal objects, as is the case for the more than two thousand panther figurines on the cloak or cape of the deceased woman (Figure 18(1–3)). This shaping technique is based on the deformation of a thin sheet of metal with the aid of a prefabricated relief that is incorporated positively or negatively into a die (Armbruster 2003a).

As a rule, such relief-bearing dies are made of bronze or hardwood. The thin sheet is simply pressed into the depressions of the relief (Figure 36). Pins or punches made of wood, antler, bone, or bronze can be used for this purpose. This work is usually done, not in one stroke, but rather, in several steps, during which the sheet slowly takes on the shape of the die. The die can also be stamp-shaped, especially in the production of small pressed-sheet items.

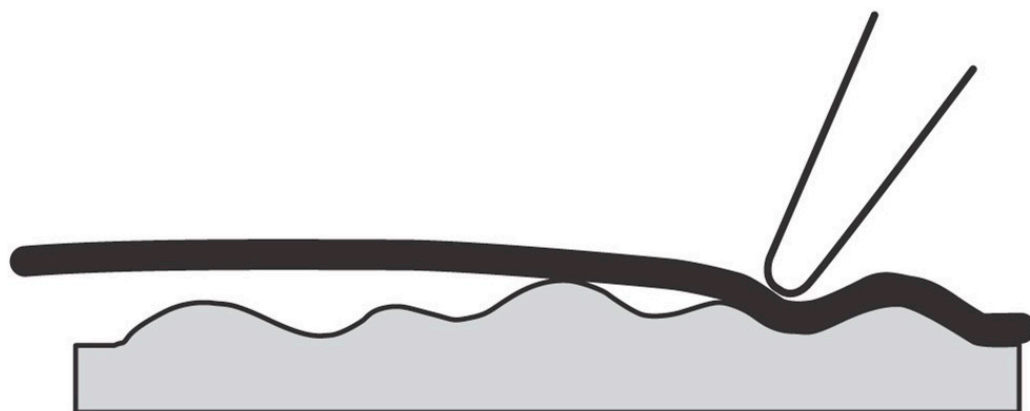

Figure 36. Schematic of the use of a die (gray) for plastic shaping of a gold sheet (black) using a pin with a rounded tip (white) (Armbruster 2004, Fig. 13, 1).

The pressed sheet-metal figurines differ from the cast examples worn by the man only in minor details; morphologically, they look very similar when viewed from a distance. While the sheet of the pressed examples is of regular thickness and the relief pattern is clearly visible on the reverse, the cast panthers have irregular walls, show no relief on the back, and have a solid-cast tail (Figure 37(1,2)). Both types of appliqués are provided with two, sometimes three, soldered sheet-metal eyelets.

Among the finds from Arzhan 2, there are also three pressed-sheet works that contain a wooden die as a stabilizing material and had been shaped on this carved wooden relief core. In some instances, the wood with relief was still preserved in the objects when they were excavated (Čugunov et al. 2010, pl. 43). The peculiarity of this technical execution of a relief is that the die is intended to remain in the workpiece to reinforce the object's structural integrity. The items are rare individual pieces, such as the scaled golden plating of the gorytos (bow-and-arrow case) (Figure 38(1–5)) and the wooden bowl (Figure 24(1–4)), both of which were made with wooden dies. This category of objects with impressed designs on wooden cores bears remarkably thick gold-sheet plating. Although these gold-sheet parts would have been fairly stable, the wooden backing was nevertheless retained to reduce the mechanical stress on the objects during their use. Such an internal scaffold was certainly required inside the handle of the wooden bowl, which was made of a single piece of wood.



Figure 37. Significant differences can be recognized in the detail of the contour, material thickness, and hollow tail; (1) pressed sheet with uniform and modest wall thickness; (2) thick-walled cast with solid tail and cutout between front and rear legs. Photos by B. Armbruster.

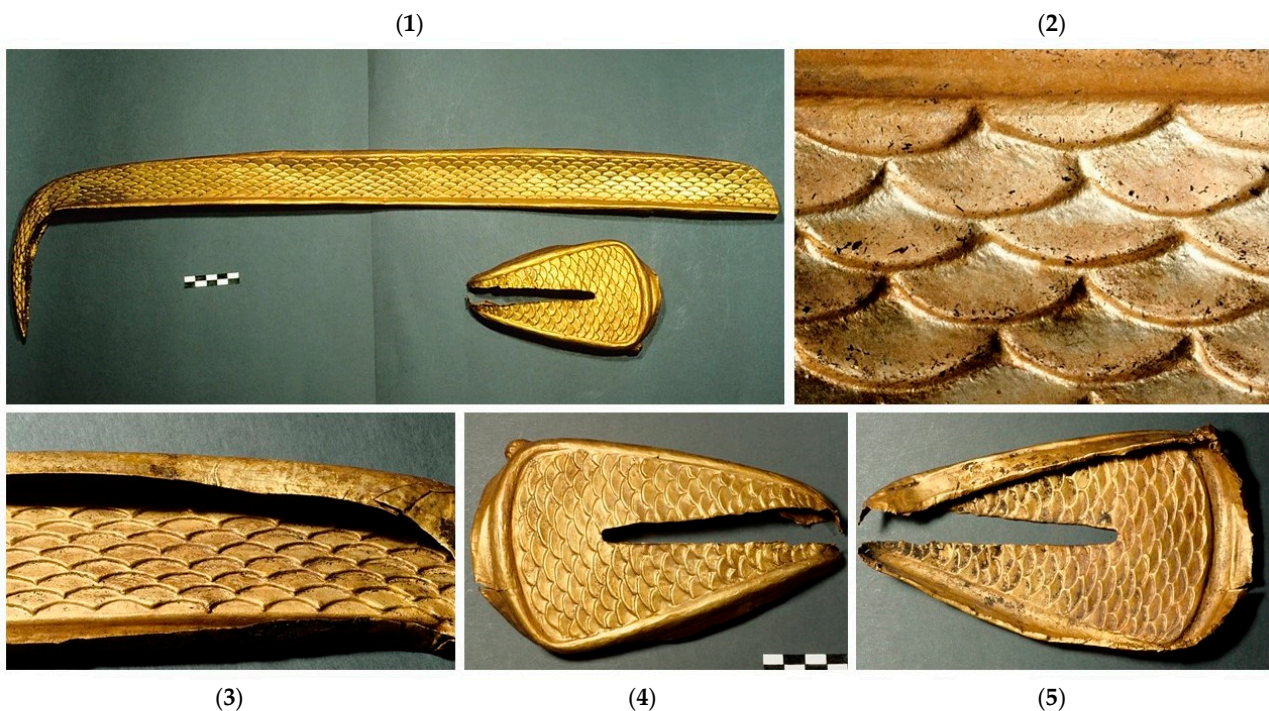

Figure 38. (1) Side-and-bottom reinforcements of the quiver (gorytos), made by pressing the gold sheet over a relief wooden model used as a die; (2,3) pressed sheet of the side reinforcement; (4,5) pressed sheet of the bottom. Photos by B. Armbruster.

Openwork in sheet metal: Openwork in sheet metal occurs in Arzhan in both animal-style objects and other work (Figure 39(1–3)). The openings are made by chiseling and engraving. The cut-out areas of the gold objects allow the color of the support material to show through. In the case of the pierced decorative plate of the female’s headdress (Figure 39(1,2)), which was fixed upright, the ambient light and colors shine through.



Figure 39. Openwork on the (1) horse plates, (2) a plate of the female's headdress, and (3) a decorative element of a pin. Photos by B. Armbruster.

Wire-making and chain-making: Wires occur at Arzhan in various thicknesses and mostly have a circular cross-section. They are used as chain links, ring-shaped constructive components of complex earrings or clasps, decorative elements for filigree work, and borders for enamel fields. Among the very few textured examples is the twisted square wire that borders the disc rings of the woman's ear ornaments (Figure 15(4)).

In the Iron Age, manual hammering could produce strong wires with square or round cross-sections with a diameter of about 0.9 mm (Drescher 1986). A round wire is obtained by hammering a square wire over the edges (Figure 40). This initially produces a polygonal cross-section and then, with further shaping, a round one (Untracht 1987, p. 248, Figs. 6–239). A metal or hardwood block with semicircular grooves, also known as a swage block, can facilitate this time-consuming work. As in other techniques of deformation, periodic annealing is an indispensable prerequisite for successful wire production.

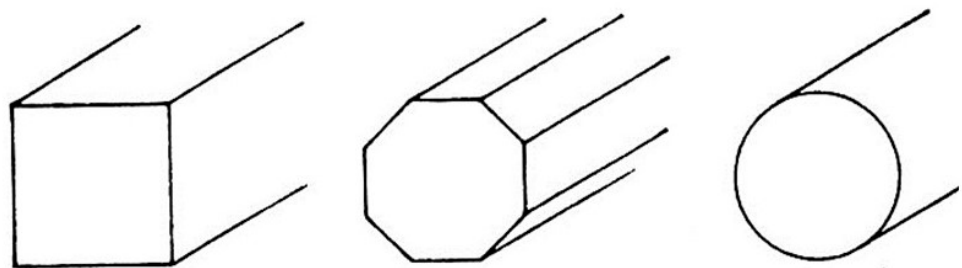

Figure 40. Hammering of wire, from square to polygonal to round cross-section (Untracht 1987, p. 248, Figs. 6–239).

Thin round wires, conversely, are twisted and rolled from narrow strips of sheet metal (strip twisted) or square precursors (block twisted) (Figure 41). This technique of wire manufacture was the common process before the introduction of the draw plate (Oddy 1977; Ogden 1982, pp. 46–58; Formigli 1993). It leaves quite characteristic manufacturing marks in the form of circumferential, helicoidal lines on the round wire. Wire-making by rolling has been widely studied and well documented for ancient gold-working.

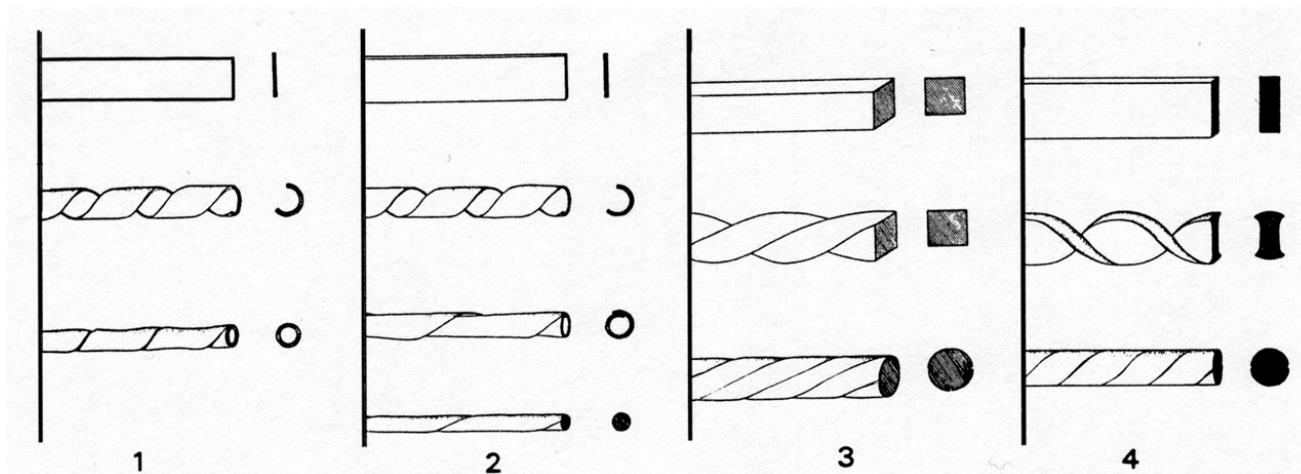

Figure 41. Schematic diagram for the production of thin filigree wire by (1,2) “strip twisting” and (3,4) “block twisting” (Formigli 1993, Figs. 2–4).

The ring-shaped chain links of the ear pendants (Figure 15(1)) and several links of the loop-in-loop chains (Figure 6(1,2,5,6)) from Arzhan 2 were closed by soldering. Other wire elements were also fixed by soldering the components to a support made of sheet metal, such as the one on the flat sheet horse and the woman’s ribbon-shaped boot trimmings with filigree, granulation, and enamel decoration (Figure 42(1,2)).



(1)

(2)

Figure 42. Helicoidal traces of wire rolling on (1) the man’s horse plate and (2) the woman’s boot fitting. Photos by B. Armbruster.

Particularly important wire works from Arzhan include the complex ring elements of the ear pendant, consisting of numerous filigree wires (Figure 15(1–7)), as well as the small-linked loop-in-loop chains on the woman’s necklace (Figure 6(1,2,5,6)) and on the miniature cauldron (Figure 7(1,3)). Otherwise, the use of wires plays a relatively subordinate role in the overall picture of the examined goldwork.

Each of the filigree rings of the woman’s paired ear ornaments is composed of an open ring formed of innumerable wires and a hollow conical sheet-metal body soldered directly to it and decorated with filigree, granulation, and enamel (Figure 15(1–7)). The open composite ring has a rectangular cross-section. The numerous gold wires were attached to each other through soldering to form a band, as we can see at the open end, where the countless wires were left visible (Figure 15(7)). The filigree work follows a scheme in which strands of five similar wire-forms were laid out parallel to each other in a zigzag pattern. Smooth round wires and wires corded from two fine round wires were used. The two rings were worked with extraordinary regularity.

Link chain: The chain found by the woman's ear pendants consists of 12 ring-shaped links made of round wire, which were hung into each other and closed by soldering (Figure 43).



Figure 43. Chain with ring-shaped links, found on the woman's ear pendants. Photo by B. Armbruster.

Loop-in-loop chains: Loop-in-loop chains occur in Arzhan 2 as two chain-strands on the woman's neck ornament (Figure 44(1,2)) and for the suspension of the miniature cauldron (Figure 7(1,3)) (Čugunov et al. 2010, pls. 78. 7a–b and 79. 2a).

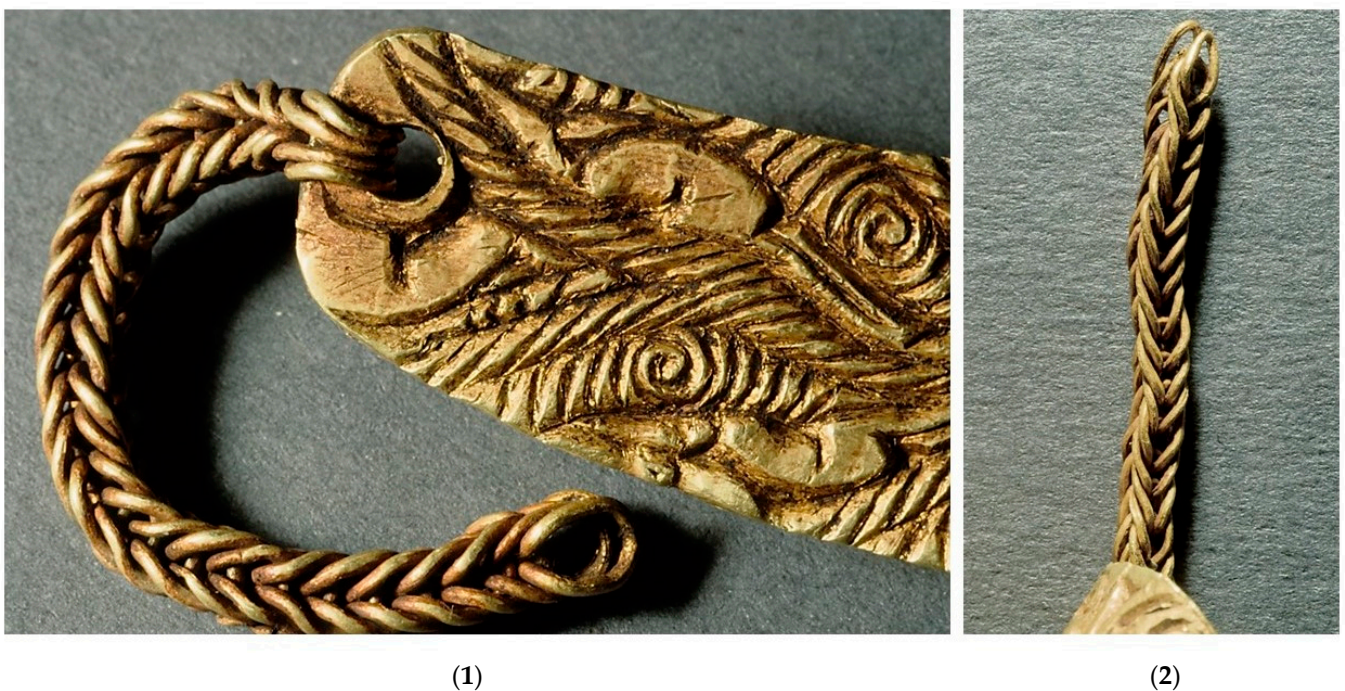

Figure 44. Loop-in-loop chain (1) of the woman's neck ornament and (2) of the miniature cauldron. Photo by B. Armbruster.

The manufacture of a loop-in-loop chain requires numerous identical wire rings or eyelets (Lemaigre 1983; Ogden 1982, p. 58). To produce these elements, a wire is usually wound tightly around a pin of appropriate diameter. The goldsmith then separates each coil using a chisel. Each individual ring is first closed by soldering the ends together. One after the other, each individually elongated wire eyelet is then pushed through the next, bending over each eyelet with looped ends to accommodate the next eyelet in the loops thus formed (Figure 45(1,2)).

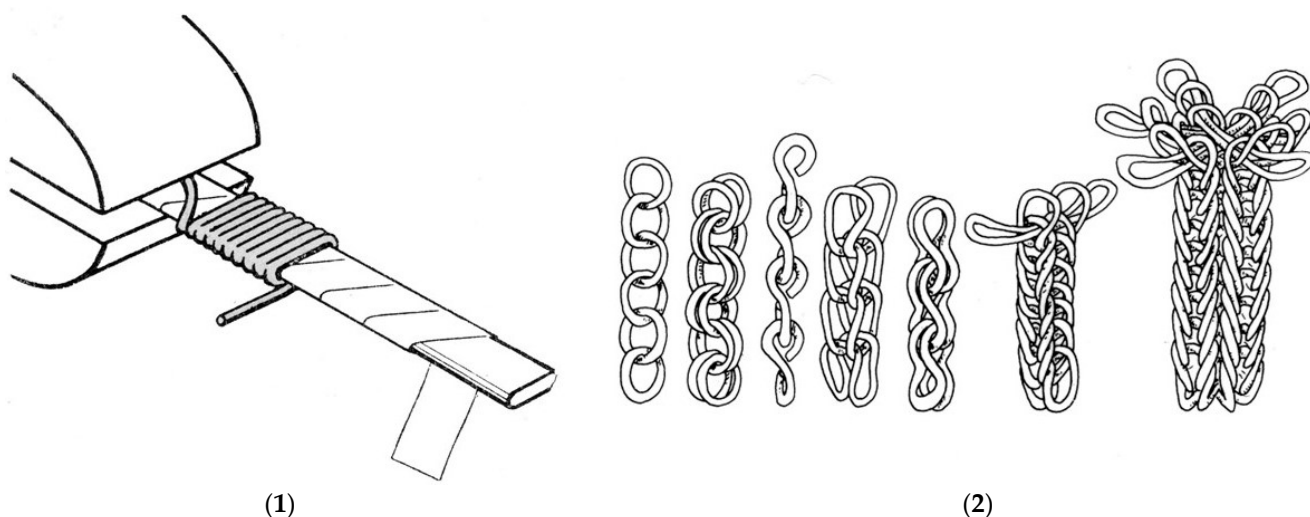

Figure 45. (1) Making equal-sized eyelets or chain links by wrapping wire around a rod (Brepohl 1980, p. 19, Fig. 142); (2) link and loop-in-loop chain-making (after Ogden 1982, p. 58, Fig. 4:45).

2.3. Connecting Techniques

Mechanical riveting or flanging and soldering have been identified as joining techniques for the construction of composite pieces. Both principles were used to assemble separate parts or to close eyelets.

Riveting: In riveting, the elements to be joined were first provided with rivet holes and then mechanically joined with a pin. In the case of cast objects, such as the woman's gold dagger handle, the holes were already devised during the casting process (Figure 21(4,5)). In the case of hammered sheet goldwork, by contrast, the rivet holes were pierced through the sheet metal with the aid of a metal point, as can be seen on the sheet-metal stag figurine (Figure 5(3,4)). The hammered rivet pin is then passed through the holes and compressed at both ends by plastic deformation in order to expand them slightly and firmly join the pieces together (Figure 46). This deformation can be achieved simply by hammering one end while the other rests on a firm support. Alternatively, one can also make use of a base with a recess, known as a rivet bench, or a hollow punch.

Riveting rarely occurred among the finds from Arzhan. In one instance, the technique was used to fix one half of the antler to the stag figurine made of sheet metal from the decoration of the man's headdress (Figure 5(3,4)). A second example of riveting can be found on the woman's dagger, as a connecting element between the golden handle and the iron blade (Figure 21(4,5)). Furthermore, in some instances, such as the gold sheet fitting of the wooden vessel, rivet holes indicate that nail-shaped pins had originally been used and are now missing. The perforations on the sheet-metal appliques from the boots of the man and woman are probably not for rivets but for sewing the plaques to their leather backing (Figures 32(1,2) and 33(4)).

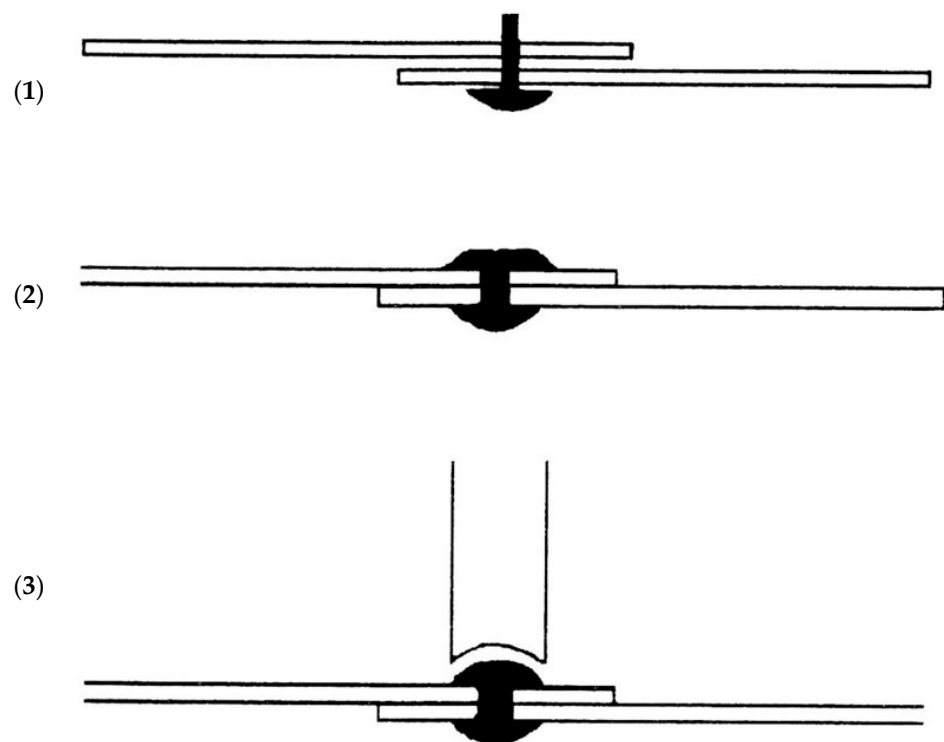

Figure 46. Rivets; two overlapping sheets. (1) Rivet pin with head; (2) deformation of second rivet head; (3) rounded rivet head and hollow punch (after [Hodges 1964](#), Fig. 13).

Flanging: Flanging is a technique of physical connection that binds metal parts by interlocking or bending. As an example, the sheet-metal stag figure found with the male was joined to its base plate by flanging (Figure 5(6)).

Dynamic physical connections: Possible methods of physical fastening also include movable links, such as hooking (see, for instance, the ring-shaped decorative element of the ear ornament, (Figures 15(2) and 52(2)), mobile eyelet connections of chain links and their attachment to an object (Figures 6, 7(3) and 44), the application of slides to a belt of organic material (Figures 22 and 28), and the sewing of beads or metallic decorative elements with small back eyelets to fabric, felt, or leather (Figures 18, 19 and 37).

Soldering: Soldering was used to join chain links or other individual elements into composite objects, such as the woman's wire and sheet-metal ear ornaments, made of two gold-sheet parts (Figures 15(1–7) and 47(1,2)) ([Lang and Hughes 1980](#); [Maryon 1936](#); [Wolters 1975](#)). Soldering was also used to attach small eyelets to the back of appliqués or to fix small elements in the form of wires or granules onto surfaces to create decorative filigree, granulation, and enamel.

The soldered pieces exhibit remnants of metallic solder, indicating that, by adding small amounts of copper, the goldsmith was able to produce a gold alloy that had a lower melting point than the gold alloy of the pieces to be soldered. Small pieces of this solder alloy were cut from sheet metal or wire in the appropriate alloy and placed on the area to be soldered. In order to protect the soldered area from oxidation, the Scythian goldsmith used a flux of unknown composition. The piece was then heated in the furnace until the solder melted and diffused into the base metal, thus joining the individual parts. Remnants of the solder alloy can be seen particularly clearly on the back of the gold-sheet horses.

Subtractive techniques—Chiseling, cutting, engraving, and scraping: The techniques of goldsmithing that remove material from the base by chipping include chiseling, cutting, engraving, and scraping. The abrasive processes of finishing by grinding and polishing can also be included in this category. Chiseling and cutting were used on the Arzhan goldwork to cut out sheet-metal motifs along the contours, as well as for the openwork of pierced pieces

(Figure 48(1–3)). Traces of the chisel can often be seen on the edge of the sheet-metal work and on the openings. Engraving was also used as a decorative technique to create engraved decorative lines. One can observe, however, the traces of engraving and scraping most commonly where the relief surface of cast notch work was finished after casting (e.g., Figures 6(3,4), 9(3–6) and 12(1,4)). Hardened iron tools were necessary for this technique.



Figure 47. Cylindrically curved and disc-shaped sheet-metal parts of the woman's ear ornaments, (1) soldered joint of the cylinder, and (2) soldered connection between the vertical and horizontal sheet elements. Photos by B. Armbruster.

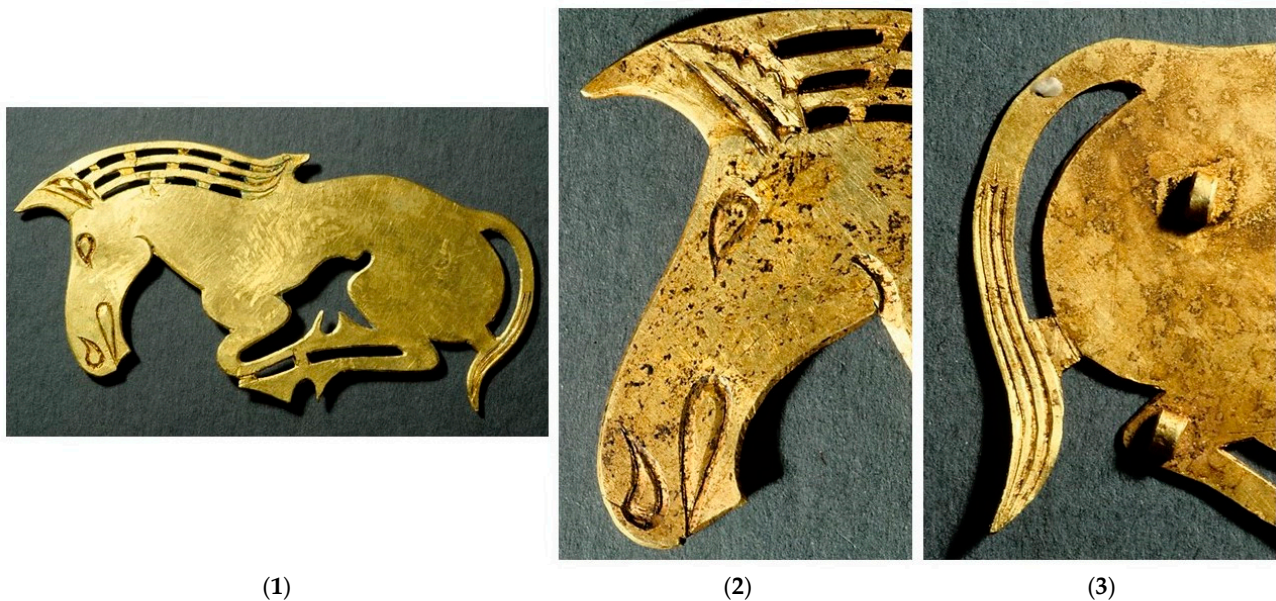

Figure 48. (1) Horse plaque from the woman; (2,3) engraved and chiseled lines and openwork on the horse's head and tail. Photos by B. Armbruster.

In chiseling, one hand holds the cutting tool while the other hand guides the percussion instrument and transfers pressure to the chisel. The chisel is a metal pin with sharpened cutting edges at one end that produces chips, thus lifting the material.

Engraving differs from chiseling in the handling of the cutting tool. The engraver's burin consists of a metal pin with cutting edges, sharpened in a specific way and set into a wooden handle (Bunte 1985; Untracht 1987). The graver is not struck with a hammer like the chisel; rather, the palm of the hand exerts the necessary pressure on the tool's wooden handle, while the engraver guides the burin. The technique produces chips and, therefore, a loss of material (Figure 49B).

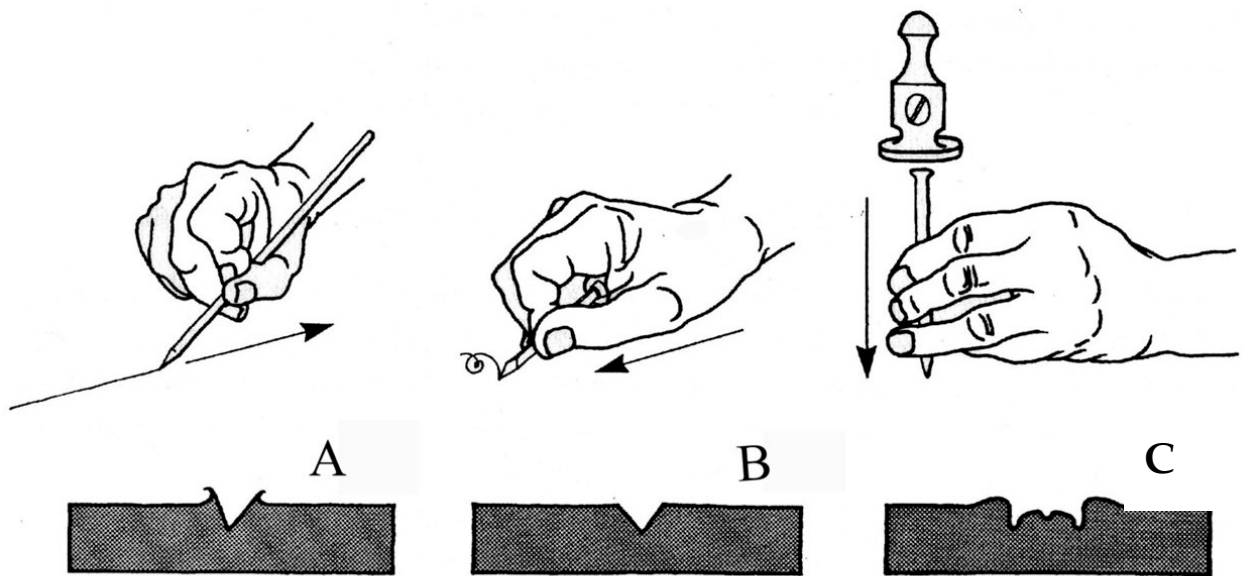

Figure 49. Differences in the handling and operational procedures for (A) the tracing of lines (with material displacement); (B) engraving (with chipping); (C) chasing (solely through plastic deformation) (after Lowery et al. 1971, p. 171).

Scraping covers a larger area than engraving or chiseling. A sharpened tool is scraped over the metal surface with pressure, thereby smoothing the surface through compression as well as abrasion. In modern metalwork, a distinction is made between impact scrapers and cranked drawing scrapers (Figure 50).

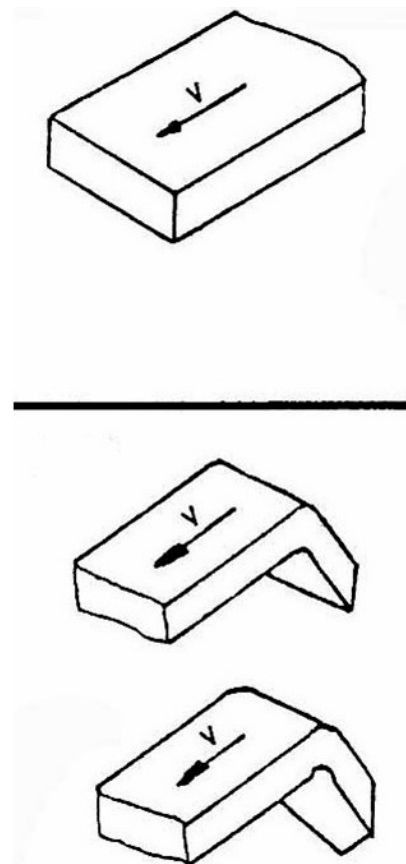

Figure 50. Flat impact scraper and cranked drawing scraper (after Autorengruppe TAG 2016, p. 38).

2.4. Decorative Techniques

Tracing preliminary drawings: On some objects, preliminary drawings can be observed on the surface. The sketch-like traces served to distribute the decoration over the available surface. Such preliminary drawings are scratched with a pointed, pin-shaped tool known as a “scriber” made of bronze or iron (see Figure 49A). A small point fixed into a wooden shaft is sufficient for this purpose. Tracing differs from engraving in that it does not remove material but merely displaces it.

Filigree and granulation: The decorative techniques of filigree and granulation are based on soldering tiny granules or small decorative elements made of wire to a metal surface (Wolters 1986, 1987). The filigree technique uses sections of thin, usually coiled, wire that have been bent into decorative elements. The numerous tiny granules needed for granulation are made by melting small pieces of gold clipped from gold sheet or wire. The technique’s principle is based on the special material property of metals that causes them to contract into spheres when in a liquid state. It is possible to produce a large number of granules by heating many small pieces of gold, separated by charcoal powder, in a clay crucible to the melting point so as to form small spheres (Nestler and Formigli 1993). After cooling, the spheres are separated by washing away the charcoal powder and can then be used as decorative elements. To attach the spheres, a gold solder that can be broken into tiny grains with coarse grinding stones is employed. The solder grains are then sprinkled over the granules and soldered in the furnace.

Both filigree and granulation occur among the Arzhan finds, mostly on sheet-metal bases, as can be seen, for instance, on the decorative elements of the woman’s ear ornaments (Figure 15(1–7)) and bootlaces (Figure 33(1–4)). Three types of granulation patterns can be identified: linear, triangular, and scatter (Figure 51(1,2)) (Nestler and Formigli 1993; Wolters 1986). In all instances, the granules are heterogenous in size, indicating that they had not been sorted.



(1)



(2)

Figure 51. (1,2) Small beads and a conical slider with enamel decoration and scatter or triangular granulation. Photos by B. Armbruster.

Two unusual applications of filigree and granulation among the Arzhan finds deserve special attention. Among them is the filigree work on the two ring-shaped elements of the ear ornaments that consisted, as already mentioned, entirely of wire and were additionally decorated with granulation and enamel (Figure 52(1,2)). Granulation occurs among the Arzhan finds not only on sheet-metal bases—on which granulation is, to this day, most commonly applied—but also on solid cast objects, such as the miniature cauldron (Figures 7(1,3) and 25(2)) and the long jewelry pin (Figure 25(1)).

Enamel: Enamel is a glass mass that is crushed into granules or powder in a mortar. In the form of small fractions, the enamel grains are placed in the designated fields before

the workpiece is heated in the furnace until the enamel mass melts and begins to adhere to the metal surface while cooling (Maryon 1971; Wessel 1971).

As a decorative technique, the process of enameling involves the application of crushed glass crystals to object surfaces. In the Arzhan finds, enamel decoration is achieved through cell fusion, also known as cloisonné enameling, a method in which the glass powder is deposited in a compartment previously delineated with wire that was soldered to the sheet-metal base for this purpose (Figures 5(1,4), 15(1–3,7), 33(1–4), 42(1,2) and 51(1,2)).

Gold and silver inlays on iron objects: The gold decorations of the iron objects from Arzhan are also of extraordinary fineness and quality.

In the inlay method, a softer metal, usually in the form of small sheet or wire elements of gold or silver, is inserted into a harder metal, such as bronze or iron (Maryon 1971; Rieth 1936; Born 1994; Wolters 2002). The physical connection is based on the clamping and interlocking of the inserted element in the specially prepared pits, cavities, grooves, or roughened surfaces on the metal substrate (Figure 53). In cast bronzes, these pits can be created in the casting process. In the case of iron objects, the pits can be worked out either through plastic deformation with the aid of a chisel or punch, or through chipping with a chisel or burin.



Figure 52. (1) Enamel remnants in the teardrop-shaped filigree cells and (2) surface enamel between the triangular granulation of the ear ornaments. Photos by B. Armbruster.

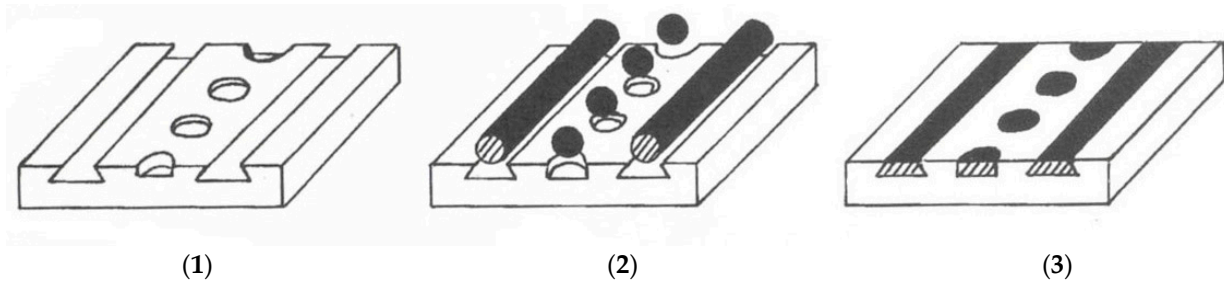

Figure 53. Three phases of inlay work. (1) Groove with undercut sidewalls in the surface of the harder metal; (2) inserts; (3) inlay of softer metal physically fixed into place through plastic deformation (after Manfredi et al. 1992).

As a rule, these pits are undercut at the sides so that the inserted material can interlock. This is done by exerting pressure with a percussion instrument. Plastic deformation usually takes place with the help of punches that transmit the hammer blow indirectly.

The man's dagger and one of the ring-handled knives show a half-relief on the blade and a three-dimensional relief on all sides of the dagger handle (Figures 13(1–4) and 54(1)). A relief can be worked into red-hot iron with the help of chisels, punches, and hammers. If the piece is worked on both sides, it is necessary to work on a bed of sand or ash so that the plastic deformation of the front side does not damage the back side. It is highly unlikely that the relief was shaped after the gold inlays had been applied. The women's dagger blade and another ring-handled knife show a flat inlay (Figures 21(1–3) and 54(2)).

To judge from several 0.3-mm-thick gold inlays from Arzhan that have fallen out (Figure 13(5)), these elements are clearly not thin pieces of foil but stable pieces of sheet metal. The backs have slight protrusions at the edges, devised to fix the inlays to the metal base or to a putty. These extensions are not visible on the front side, suggesting that the individual elements were made separately and then inserted into the surface. Perhaps additional organic adhesives were used to create a stronger bond.



(1)

(2)

Figure 54. (1) On one of the knife handles, the gold inlays were sculpted to match the relief of the iron base (Figure 13(1)). (2) Flat inlay. Photos by B. Armbruster.

3. The Goldsmiths' Tools

Given the complexity of their products, the goldsmith workshops that produced the finds from Arzhan 2 must have been equipped with versatile tools. Since no tools have been discovered that can provide direct insight into Early Scythian workshop practices, the range of equipment employed must be inferred indirectly from the traces of work and other features preserved on the objects' surfaces. Furthermore, we can arrive at a general picture of the equipment by drawing parallels with documented workshop remains from the Late Bronze Age and Early Iron Age. Explanatory models for the manufacturing processes that were potentially in use can also be developed through analogies drawn from an interdisciplinary approach to research that combines information from a range of scientific fields.

The workshops' utensils were no doubt highly adaptable without relying on any permanent installations. The furnace most likely consisted of a simple pit loaded with charcoal as fuel. The fire must have been fanned by a bellows, possibly made of goatskin. The bellows, crucible, tongs, and tools of plastic deformation could be stored in a sack or box and were easy to transport. In Mali, for instance, goldsmiths who smelt, cast, and forge, as well as produce goldwork with granulation and filigree, move about the country with mobile workshops (Armbruster 1995, p. 130); only the furnace and possibly the wooden pole for fixing the anvil must be set up at each temporary encampment. Mobile metal

workshops of nomadic itinerant metal workers, like those we presume to have made the Early Scythian goldsmith art, can still be observed in non-European countries.

From the finds at Arzhan, the following goldsmith tools can be deduced. An Early Scythian workshop must have had molds for the casting process, with a furnace and bellows, crucibles, and tongs for holding, transporting, and tilting the crucible containing the melting material. For the lost-wax casting process, wax or hardened fat is needed for the models. Refractory clays and organic leavening agents are the presumed ceramic materials needed to encase the wax model as a clay mold and to create the casting crucibles. Solid molds made of wood or metal, and two-part molds were probably used for the serial production of the wax models. Furthermore, fuel was required, which may have included charcoal, animal dung, and other combustible organic residues, such as nutshells.

In addition to casting, the goldsmith's furnace was also used for the intermediate annealing of objects undergoing plastic shaping, such as hammering or chasing, to prevent them from becoming brittle during the process of plastic deformation. A furnace was also required for soldering and enamel work. It can be assumed that, for this purpose, the goldsmith made him- or herself a small muffle of clay that protected the workpiece in the furnace from ash and other dirt, and ensured uniform firing conditions.

In order to clean the casts, various substances for grinding and polishing the surface were used, among them stones or other abrasives, such as sand or ash, or dried siliceous plants, notably, horsetail. Subsequently, the surfaces of the cast objects could be further refined through plastic deformation with punches, most likely made of bronze.

In the next phase, chipping tools were employed, among them chisels, gravers, and scrapers. As various experiments and resistance measurements have shown, tools made of bronze or soft iron are unsuitable for chipping or notching precious metals. Tools made of carburized iron (that is, steel) must have been present in the tool inventory of the Early Scythian goldsmiths. Such tools may have consisted of small hardened and sharpened blades that were mounted in a wooden handle. The sharpening of the working end could have been accomplished through forging and grinding. Hardening soft iron tools by carburizing or nitrite-hardening is a relatively uncomplicated practice. In fact, this technique is still in use today among traditional itinerant goldsmiths. As an example, ethnographic observation in Mali has shown that this process can be performed with simple ingredients, such as salt, horn shavings, and charcoal. The procedures used by traditional African goldsmiths and ironsmiths to harden chisels, burins, or files are comparable in their chemical effects to the nitrite baths employed in modern industrial production ([Armbruster 1995](#), p. 121).

Chisels were also used to remove casting protrusions, casting channels, sheets, or wires, and cut out the contours or openings of a sheet-metal object, while pointed mandrels served to punch holes.

For the techniques that involved plastic deformation, the equipment of the Scythian goldsmiths included hammers, anvils, chisels, punches, drawing needles, and dies. The hammer and anvil were used to produce sheet metal, rods, and wires for finishing casts and any necessary hammering work. Another type of tool for shaping metal is the forming or dapping block—a cuboid of metal, wood, or stone with depressions in the form of hemispheres (doming block) or grooves (swage block) of various dimensions. By pushing and pressing metal in the appropriate openings of such blocks, sheet metal can be transformed into domes for beads or wires with round or triangular cross-sections.

Finally, punches were used to smoothen the rough surfaces of the cast notched reliefs. An examination of the objects from Arzhan also shows that those shaped with the aid of a die were subsequently worked over with punches. Modeling punches of various shapes and sizes must have been in use. On some panther figures produced through the pressing of sheet with dies, a pointed punch was also employed to emphasize the feline's eyes with a punched border. Curiously, no impressions of decorative punches with a design at their working end appear to have been in use. In other geographical regions, such punches and dies are standard items in the goldsmith's tool repertoire.

Dies made of metal were used for the serial production of small, pressed sheet-metal work. Dies made of wood were used to produce large individual pieces of sheet metal in which the wooden lining remained in the object as reinforcement.

Apart from the aforementioned tools made of bronze, iron, stone, and ceramics, the Scythian artisans must also have used substances like salts and acids, which are commonly found in goldsmiths' workshops as cleaning agents for workpieces.

4. Concluding Remarks

The extraordinary discovery of the intact elite tomb of Arzhan 2 offers new insights into the complex goldsmithing techniques of the Early Scythians in Siberia. While gold ornaments were made for both the living and the dead, most pieces known to us were intended exclusively for funeral ceremonies, as is evident from the lack of wear and the occasional presence of burrs and ridges from the casting process. They attest to the region's high technical and artistic level of goldsmithing craft in the late 7th and early 6th centuries BCE. The works bear out how highly developed the organization and specialization of the applied arts were and how extensive the cultural contacts of the equestrian nomads must have been. The early dating demonstrates that the precious metalwork from Arzhan 2 predates any parallels from Kazakhstan. The finds are considered the earliest evidence to date of this elaborate and versatile technology in Scythian Siberia, while the characteristic design features of the Early Scythian animal style clearly indicate local production. It should also be noted, however, that sophisticated techniques of goldsmithing—including lost-wax casting, soldering, filigree, granulation, and enameling—were known prior to the 7th century BCE, both further afield in the Near East, and in the Mediterranean.

This brief account of a wide range of virtuoso gold-working techniques among the Early Scythians reveals highly sophisticated traditions of material knowledge and technology. The gold objects from Arzhan also provide reliable (if indirect) evidence for reconstructing the equipment employed in the goldsmiths' workshops. Ethnological analogies show that the tools of a mobile workshop can be easily gathered in a bag or other container and transported over long distances. This observation is consistent with the Scythians' nomadic lifestyle. Four main groups of craft traditions can be identified among the objects: cast products with notched reliefs; chased and pressed sheet metal; objects with granulation, filigree, and enamel; and gold and silver inlays in iron.

The precious metal finds from Arzhan are both aesthetically and technologically of very high quality, and represent a considerable investment in material, labor, and knowledge. The details of their design and manufacture offer an unprecedented glimpse into a previously little-understood Early Scythian metalworking tradition. As mentioned initially, to date, no direct parallels for such a rich and highly developed knowledge of precious metalworking techniques are known anywhere in southern Siberia or further afield in the eastern steppe belt.

Author Contributions: Conceptualization, B.A. and C.M.; methodology, B.A. and C.M.; formal analysis, B.A. and C.M.; investigation, B.A. and C.M.; resources, B.A. and C.M.; data curation, B.A. and C.M.; writing—original draft preparation, B.A.; writing—review and editing, B.A. and C.M.; visualization, B.A. and C.M. All authors have read and agreed to the published version of the manuscript.

Funding: This research received no external funding.

Data Availability Statement: Data available on request from the author.

Acknowledgments: The authors would like to thank Hermann Parzinger and the Eurasia Department of the German Archaeological Institute in Berlin for their invitation to study the goldsmiths' work from Arzhan 2. During the principal author's visit to the State Hermitage Museum in Saint Petersburg, her investigations were supported by Konstantin Chugunov, Svetlana Burshneva, and Rafael Minasyan.

Conflicts of Interest: The author declares no conflict of interest.

Notes

- ¹ This publication also features the full dimensions and weights of the objects discussed in the present article (Čugunov et al. 2010, pp. 26–86). Since this information is either irrelevant to our examination or is visible from the scales included in the photographs, it has not been restated here.

References

- Alexeyev, Andrey. 2012. *The Gold of the Scythian Kings: In the Hermitage Collection*. St. Petersburg: State Hermitage Publishers.
- Antonini, C. Silvi. 1998. L'arte animalistica nelle steppe. In *L'uomo d'oro. La cultura delle steppe del Kazakistan dall'eta del bronzo alle grandi migrazioni*. Edited by Grigore Arbore Popescu, C. S. Antonini and K. Baipakov. Milano: Electa, pp. 77–86.
- Armbruster, Barbara. 1993. A study on lost wax casting processes in Mali and Burkina Faso (Western Africa). Workshops and casting techniques as ethno-archaeological demonstration material. In *Atti del seminario antiche officine del bronzo. Materiali, strumenti, tecniche, Murlo 1991*. Edited by Edilberto Formigli. Siena: Nuova Immagine Editrice, pp. 153–64.
- Armbruster, Barbara. 1995. Traditionelles Goldschmiedehandwerk in Westafrika und bronzezeitliche Metallverarbeitung in Europa. Technologien im ethnoarchäologischen Vergleich. *Beiträge zur Allgemeinen und Vergleichenden Archäologie* 15: 111–201.
- Armbruster, Barbara. 2001. Metallguß. In *Reallexikon der Germanischen Altertumskunde* 19. Edited by Heinrich Beck, Dieter Geuenich and Heiko Steuer. Berlin and New York: De Gruyter, pp. 622–42.
- Armbruster, Barbara. 2003a. Preßblecharbeiten. Technologisches. In *Reallexikon der Germanischen Altertumskunde*. 23. Edited by Heinrich Beck, Dieter Geuenich and Heiko Steuer. Berlin and New York: De Gruyter, pp. 409–13.
- Armbruster, Barbara. 2003b. Punze, Punzieren. In *Reallexikon der Germanischen Altertumskunde*. 23. Edited by Heinrich Beck, Dieter Geuenich and Heiko Steuer. Berlin and New York: De Gruyter, pp. 602–7.
- Armbruster, Barbara. 2004. Goldsmiths' tools at Hedeby. In *Land, Sea and Home. Proceedings of a Conference on Viking-Period Settlement at Cardiff, July 2001. Society for Medieval Archaeology Monograph* 20. Edited by John Hines, Alan Lane and Mark Redknap. Leeds: Taylor & Francis Group, pp. 109–23.
- Armbruster, Barbara. 2007. Die Goldschmiedetechnik von Arzhan 2. In *Im Zeichen des goldenen Greifen*. Edited by Wilfried Menghin and Hermann Parzinger. München, Berlin, London and New York: Prestel, pp. 95–99.
- Armbruster, Barbara. 2009. Gold technology of the ancient Scythians—Gold from the kurgan Arzhan 2, Tuva. La technologie de l'or chez les Scythes anciens—l'or du kurgan Arjan 2 Touva. *ARCHEOSCIENCES—Revue d'Archéométrie* 33: 187–93. [CrossRef]
- Armbruster, Barbara. 2010. Technologische Aspekte der Goldschmiedekunst aus Arzan 2. In *Der skythenzeitliche Fürstengurgan Arzan 2 in Tuva. Archäologie in Eurasien* 26. Edited by Konstantin V. Čugunov, Hermann Parzinger and Antoni Nagler. Berlin: Philipp von Zabern, pp. 174–90.
- Armbruster, Barbara. 2014. Ethnoarchäologie und Experimentelle Archäologie in der prähistorischen Goldforschung. In *Metalle der Macht—Frühes Gold und Silber. Metals of power—Early gold and silver*. 6. *Mitteldeutscher Archäologentag, vom 17. bis 19. Oktober 2013 in Halle (Saale). 6th Archaeological Conference of Central Germany, October 17–19, 2013 in Halle (Saale). Tagungen des Landesmuseums für Vorgeschichte Halle. Band 11/I*. Edited by Harald Meller, Roberto Risch and Ernst Pernicka. Halle: Landesamt für Denkmalpflege und Archäologie Sachsen-Anhalt, pp. 323–34.
- Armbruster, Barbara, and Maria Filomena Guerra. 2003. L'or archéologique, une approche interdisciplinaire. *Techné* 18: 57–62.
- Aruz, Joan, Ann Farkas, Andrei Alekseev, and Elena Korolkova, eds. 2000. *The Golden Deer of Eurasia: Scythian and Sarmatian Treasures from the Russian Steppes*. New York: MetPublications.
- Autorengruppe TAG. 2016. *Technisch-Wissenschaftliche Grundlagen des Goldschmiedens Teil 1. Grundtechniken der Herstellung von Schmuck und Gerät. Goldschmiedeschule mit Uhrmacherschule Pforzheim & Fachredaktion Uhren-Juwelen-Schmuck*. Pforzheim: Autorengruppe TAG.
- Babenko, Leonid. 2023. The pectoral of Tovsta Mohyla: Understanding the gold insignia of ancient Scythia. *Arts* 12: 136. [CrossRef]
- Bidzilya, Vasilii I., and Sergei V. Polin. 2012. *Skifskii tsarskii kurgan Gaimanova Mogila*. Kyiv: Izdatel'skii dom Skif.
- Born, Hermann. 1994. Terminologie und Interpretation von Tauschierertechniken in der altvorderasiatischen, altägyptischen und alteuropäischen Metallkunst. In *Tauschierarbeiten der Merowingerzeit. Kunst und Technik. Bestandskataloge* 2. Edited by Wilfried Menghin. Berlin: MVF Staatliche Museen zu Berlin, pp. 72–81.
- Brepohl, Eberhard. 1980. *Theorie und Praxis des Goldschmieds*. Leipzig: Carl Hanser Verlag GmbH & Co. KG.
- Bunte, Ute. 1985. Ziertechniken auf Bronzeoberflächen. In *Archäologische Bronzen, antike Kunst, Moderne Technik*. Edited by Hermann Born. Berlin: D. Reimer, pp. 58–63.
- Corwin, Nancy Megan. 2010. *Chasing and Repousse: Methods Ancient and Modern*. London: Brynmorgen Press.
- Čugunov, Konstantin V., Hermann Parzinger, and Antoni Nagler. 2003. Der skythische Fürstengrabhügel von Aržan 2 in Tuva. Vorbericht der russisch-deutschen Ausgrabungen 2000–2002. *Eurasia Antiqua* 9: 113–62.
- Čugunov, Konstantin V., Hermann Parzinger, and Antoni Nagler. 2006. *Der Goldschatz von Aržan. Ein Fürstengrab der Skythenzeit in der südsibirischen Steppe*. München: Schirmer Mosel.
- Čugunov, Konstantin V., Hermann Parzinger, and Antoni Nagler, eds. 2010. *Der skythenzeitliche Fürstengurgan Arzan 2 in Tuva. Archäologie in Eurasien* 26. Berlin: Philipp von Zabern.
- Cunliffe, Barry. 2019. *The Scythians: Nomad Warriors of the Steppe*. Oxford: Oxford University Press.
- Drescher, Hans. 1986. Draht. In *Hoops RGA?* 6. Berlin and New York: De Gruyter, pp. 140–52.

- Formigli, Edilberto. 1993. Sulla tecnica di costruzione dei fili d'oro nell'oreficeria etrusca. In *Symposium "Outils et ateliers d'orfèvre des temps anciens" (Saint-Germain-en-Laye 1991). Antiquités Nationales, mémoire 2*. Edited by C. Eluère. Saint-Germain-en-Laye: Société des Amis du Musée des Antiquités Nationales et du château de Saint-Germain-en-Laye, pp. 35–38.
- Franchi, Claudio, and Gian Luca Bonora. 2005. Technique e sapetti manifatturieri. In *I tesori della steppa di Astrakhan. Mostra 17 marzo al 29 maggio Palazzo Venezia, Roma*. Edited by Larissa Anisimova, Gian Luca Bonora, Claudio Franchi, Lyudmila M. Karaeva and Viacheslav V. Plakhov. Milano: Electa, pp. 46–55.
- Fröhlich, Max. 1981. Zur Technik des Goldgusses der Ashanti (Ghana). In *Das Gold in der Kunst Westafrikas*. Edited by Eberhard Fischer and Hans Himmelheber. Zürich: Museum Rietberg, pp. 43–58.
- Fröhlich, Max, and Ruth Fröhlich. 1974. *Benvenuto Cellini. Abhandlungen über die Goldschmiedekunst und die Bildhauerei*. Basel: Kirschgarten.
- Griaznov, Michail Petrovič. 1984. *Der Grosskurgan von Aržan in Tuva Südsibirien*. Munich: Beck.
- Hodges, Henry. 1964. *Artifacts. An introduction to early materials and technology*. London: Bristol Classical Press.
- Hunt, Leslie B. 1980. The long history of lost wax casting. Over five thousand years of art and craftsmanship. *Gold Bulletin* 12: 63–79. [\[CrossRef\]](#)
- Jettmar, Karl. 1979. Die zentralasiatische Entstehung des Tierstils. *Beiträge zur Allgemeinen und Vergleichenden Archäologie* 1: 145–58.
- Korolkova, Elena Fiodorovna. 2017. The Siberian collection of Peter the Great. In *Scythians: Warriors of Ancient Siberia*. Edited by St. John Simpson and Svetlana Pankova. London: The British Museum, pp. 34–41.
- Kossack, Georg. 1980. Mittelasien und skythischer Tierstil. *Beiträge zur Allgemeinen und Vergleichenden Archäologie* 2: 91–107.
- Lang, Janet, and Michael J. Hughes. 1980. Joining techniques. In *Aspects of early metallurgy. British Museum Occasional Paper 17*. Edited by W. A. Oddy. London: The British Museum, pp. 169–78.
- Lemaigre, A. C. 1983. Chains and necklaces. In *Gold Jewelry*. Edited by T. Hackens and R. Winkers. Louvain La Neuve: Publications d'histoire de l'art et d'archéologie de l'Université catholique de Louvain, pp. 205–10.
- Lemonnier, Peter. 1992. *Elements for an Anthropology of Technology*. Ann Arbor: University of Michigan, Museum of Anthropology.
- Leroi-Gourhan, André. 1993. *Gesture and Speech*. Cambridge: Massachusetts Institute of Technology.
- Lowery, Phillip R., Richard D. A. Savage, and Robert L. Wilkins. 1971. Scribe, graver, scorer, tracer: Notes on experiments in bronze working technique. *Proceedings of the Prehistoric Society* 37: 167–82. [\[CrossRef\]](#)
- Manfredi, Sophie, Françoise Passard, and Jean-Pierre Urlacher, eds. 1992. *Les derniers barbares au coeur du massif du Jura. La nécropole mérovingienne de la grande Oye à Doubs, VIe-VIIe après J.-C. Besançon: Cêtre*.
- Mantsevich, Anastasia Petrovna. 1987. *Kurgan Solokha: Publikatsii odnoi kolleksii*. Leningrad: Iskusstvo.
- Maryon, Herbert. 1936. *Soldering and Welding in the Bronze Age and Early Iron Age*. Technical Studies in the Field of the Fine Arts. Boston: Harvard University, vol. 5, pp. 75–108.
- Maryon, Herbert. 1971. *Metalwork and Enamelling*. New York: Dover Publications Inc.
- Meyer, Caspar. 2013. *Greco-Sythian Art and the Birth of Eurasia. From Classical Antiquity to Russian Modernity*. Oxford: Oxford University Press.
- Minasjan, Rafael Sergejevič. 1998. Zur Herstellungstechnik der Gold- und Silbergegenstände. In *Königskurgan Certomlyk. Ein skythischer Grabhügel des 4. vorchristlichen Jahrhunderts. Hamburger Forschungen zur Archäologie 3*. Edited by Renate Rolle, Viaceslav Ju. Murzin and Andrey Alekseev. Mainz: Philipp von Zabern, pp. 167–84.
- Minasjan, Rafael Sergejevič. 2004. Sekrety skifskikh yuvelirov. In *Aržan: Istočnik v Doline carej; archeologičeskie otkrytija v Tuve. Ėrmitaže, Sankt Peterburg*. Edited by Mikhail Borisovich Piotrovskij and Hermann Parzinger. Sankt-Petersburg: Slaviya, pp. 40–44.
- Minasjan, Rafael Sergejevič. 2014. *Metalloobrabotka v drevnosti i srednevekov'e*. Sankt-Peterburg: Gosudarstvennyj Ėrmitaž.
- Nestler, Gerhard, and Edilberto Formigli. 1993. *Etruskische Granulation. Eine antike Goldschmiedetechnik*. Siena: Nuova Immagine.
- Nicolini, Gérard. 1990. *Techniques des ors antiques. La bijouterie ibérique du VIIIe au IVe siècle. 1 & 2*. Paris: Picard.
- Oddy, Andrew. 1977. The production of gold wire in Antiquity. Hand-making methods before the introduction of the draw-plate. *Gold Bulletin* 10: 79–87. [\[CrossRef\]](#)
- Ogden, Jack. 1982. *Jewellery of the Ancient World*. London: Trefoil Books.
- Parzinger, Hermann. 2009. Die frühen Reiternomaden der eurasischen Steppe: Neue Lebens- und Gesellschaftsformen zwischen Jenissei und unterer Donau. In *Das Gold der Steppe. Fürstengräber jenseits des Alexanderreich*. Edited by W. Seipel. Wien: Kunsthistorisches Museum, pp. 16–29.
- Parzinger, Hermann. 2011. *Aržan 2 und die frühe Skythenzeit in Südsibirien. Terra Scythica: Materialy meždunarodnogo simpoziuma "Terra Scythica", 17–23 avgusta 2001 g., Denisova peščera, Gornyi Altaj*. Novosibirsk: Verlag des Instituts für Archäologie und Ethnographie der SA RAW, pp. 192–203.
- Parzinger, Hermann. 2017. Burial mounds of Scythian elites in the Eurasian steppe: New discoveries. *Journal of the British Academy* 5: 331–55.
- Piotrovskij, Mikhail Borisovich, and Hermann Parzinger. 2004. *Aržan: Istočnik v Doline carej; archeologičeskie otkrytija v Tuve; [izdanie podgotovleno po materialam vystavki, organizovannoj v Gosudarstvennom Ėrmitaže, Sankt Peterburg, so 2 marta po 2 maja 2004 goda]*. Sankt-Petersburg: Slaviya.
- Popescu, Grigore Arbore, Chiara Silvi Antonini, and Karl Baipakov, eds. 1998. *L'uomo d'oro. La cultura delle steppe del Kazakhstan dall'eta del bronzo alle grandi migrazioni*. Milano: Electa.
- Rahman, S. 1990. Unique find of gold ornaments from Pattan (Kohistan). *Journal of Central Asia* 13: 5–18.

- Rieth, Adolf. 1936. Anfänge und Entwicklung der Tauschieretechnik. *Eurasia Septentrionalis Antiqua* 10: 187–98.
- Rolle, Renate. 1998. *Königskurgan Čertomlyk: Ein skythischer Grabhügel des 4. vorchristlichen Jahrhunderts*. Mainz: Philipp von Zabern.
- Rudenko, Sergej Ivanovič. 1962. *Die Sibirische Sammlung Peters I*. Moscow: Verlag der Akademie der Wissenschaften der UdSSR.
- Schiltz, Véronique. 1994. *Les Scythes et les nomades des steppes, VIIIe siècle avant J.-C.–Ier siècle après J.-C.* Paris: Gallimard.
- Sias, Fred S. 2005. *Lost-Wax Casting. Old, New and Inexpensive Methods*. Penleton: Woodsmere Press.
- Sillar, Bill, and Michael S. Tite. 2000. The challenge of ‘technological choices’ for materials science approaches in archaeology. *Archaeometry* 42: 2–20. [[CrossRef](#)]
- Simpson, St. John, and Svetlana Pankova, eds. 2017a. Early nomads of Central Asia and southern Siberia. In *Scythians: Warriors of Ancient Siberia*. London: The British Museum, pp. 72–81.
- Simpson, St. John, and Svetlana Pankova. 2017b. *Scythians: Warriors of Ancient Siberia*. London: The British Museum.
- Steines, Adolf. 2001. *Moving Metal the Art of Chasing and Repousse*. Huntingdon: Blue Moon Press.
- Stepanova, Elena, and Svetlana Pankova. 2017. Personal appearance. In *Scythians: Warriors of Ancient Siberia*. Edited by St. John Simpson and Svetlana Pankova. London: The British Museum, pp. 90–97.
- Untracht, Oppi. 1987. *Jewelry Concepts and Technology*. London: Doubleday.
- Wessel, Klaus. 1971. Email. In *Reallexikon zur Byzantinischen Kunst* 2. Edited by Klaus Wessel. Stuttgart: Hiersemann Verlag, pp. 111–30.
- Wolters, Jochem. 1975. *Zur Geschichte der Löttechnik*. Hanau-Wolfgang: Degussa.
- Wolters, Jochem. 1986. *Die Granulation. Geschichte und Technik einer alten Goldschmiedekunst*. München: Callwey.
- Wolters, Jochem. 1987. Filigran. In *Reallexikon zur Deutschen Kunstgeschichte*. 8. München: Beck, pp. 1062–184.
- Wolters, Jochem. 2002. Tauschierung. In *Lexikon des Mittelalters*. 8. München: Artemis-Verlag, pp. 510–11.
- Wübbenhorst, Heinz, and Gerhard Engels. 1989. *5000 Jahre Giessen von Metallen: Fakten, Daten, Bilder zur Entwicklung der Giessereitechnik*. Düsseldorf: Giesserei-Verlag.
- Zaitseva, Ganna Ivanovna, Konstantin V. Chugunov, Valentin A. Dergachev, Antoni Nagler, Hermann Parzinger, E. Marian Scott, Anatolij A. Sementsov, Sergey Vasiliev, Bas van Geel, and Johannes van der Plicht. 2004. Chronological studies of the Arzhan 2 Scythian monument in Tuva (Russia). *Radiocarbon* 46: 277–84. [[CrossRef](#)]

Disclaimer/Publisher’s Note: The statements, opinions and data contained in all publications are solely those of the individual author(s) and contributor(s) and not of MDPI and/or the editor(s). MDPI and/or the editor(s) disclaim responsibility for any injury to people or property resulting from any ideas, methods, instructions or products referred to in the content.