

Review

The Power System and Microgrid Protection—A Review

Jalal Sahebkar Farkhani ¹, Mohammad Zareein ², Arsalan Najafi ^{3,*} , Rui Melicio ^{4,5} 
and Eduardo M. G. Rodrigues ^{6,*} 

¹ Department of Electrical and Computer Engineering, University of Birjand, Birjand 97175, Iran; jalal.sahebkar@birjand.ac.ir

² Department of Engineering, University of Ferdowsi, Mashhad 91779, Iran; mohammadzareein@mail.um.ac.ir

³ Faculty of Engineering, Sepidan Branch, Islamic Azad University, Sepidan 73611, Iran

⁴ IDMEC, Instituto Superior Técnico, Universidade de Lisboa, 1049-001 Lisbon, Portugal; ruimelicio@gmail.com

⁵ ICT, Department Física, Escola de Ciências e Tecnologia, Universidade de Évora, Largo dos Colegiais 2, 7004-516 Évora, Portugal

⁶ Management and Production Technologies of Northern Aveiro—ESAN, Estrada do Cercal 449, Santiago de Riba-Ul, 3720-509 Oliveira de Azeméis, Portugal

* Correspondence: arsalan.najafi@iausepidan.ac.ir (A.N.); emgrodrigues@ua.pt (E.M.G.R.)

Received: 11 October 2020; Accepted: 18 November 2020; Published: 21 November 2020



Abstract: In recent years, power grid infrastructures have been changing from a centralized power generation model to a paradigm where the generation capability is spread over an increasing number of small power stations relying on renewable energy sources. A microgrid is a local network including renewable and non-renewable energy sources as well as distributed loads. Microgrids can be operated in both grid-connected and islanded modes to fill the gap between the significant increase in demand and storage of electricity and transmission issues. Power electronics play an important role in microgrids due to the penetration of renewable energy sources. While microgrids have many benefits for power systems, they cause many challenges, especially in protection systems. This paper presents a comprehensive review of protection systems with the penetration of microgrids in the distribution network. The expansion of a microgrid affects the coordination and protection by a change in the current direction in the distribution network. Various solutions have been suggested in the literature to resolve the microgrid protection issues. The conventional coordination of the protection system is based on the time delays between relays as the primary and backup protection. The system protection scheme has to be changed in the presence of a microgrid, so several protection schemes have been proposed to improve the protection system. Microgrids are classified into different types based on the DC/AC system, communication infrastructure, rotating synchronous machine or inverter-based distributed generation (DG), etc. Finally, we discuss the trend of future protection schemes and compare the conventional power systems.

Keywords: protection system challenges; microgrid; protection schemes; wide area protection; intelligent algorithms

1. Introduction

Protection system schemes have increasingly become important due to the increasing complexity and challenges in power systems. The miscoordination and false tripping of protective relays have played a significant role in blackouts and in propagating cascading events [1]. The North American Electric Reliability Council (NERC) has reported that the contribution of protection systems in cascading events is more than 70% [2]. A CIGRÉ [3] study has stated that 27% of bulk power system disturbances result from false trips of tie protection systems. Figure 1 illustrates an update of some major blackouts and disturbances all around the world [3,4].



Figure 1. Worldwide major system disturbances and blackouts in the past several decades.

The main task of a protection system is to separate the fault section from the healthy part for a stable supply of electrical energy without any interruption, cascading failures, and blackout events. Conventional power system coordination includes the primary and back-up protection [5,6]. The main parts of the power system (grid), including generation, high voltage transmission line, and distribution, have to be adjusted to appropriate settings. The protection challenges significantly increase with the growth of the power system.

Generation: There are many protective functions and protection schemes in generator protection systems. The authors in References [7,8] investigated the differences between distance (21) and voltage-controlled or voltage-restraint time-overcurrent (51V) protective relays as the backup protection of a generator. Investigations revealed that the relays 21 and 51V protection functions should not be activated in a zone relay protection system. Depending on the upstream system configuration, both protective relays function 21 or 51V can be used as the generator backup protection. The 21 and 51V protective functions are used as back up protection with, respectively, distance relays and directional overcurrent (DOC) relays in transmission lines.

High voltage transmission lines: Transmission systems are used for delivering electrical energy from generation to customer. There are a lot of faults that occur in the transmission system due to the expansion and long lines. Distance protection is one of the most commonly used ways to protect transmission lines with different zones. Power swing is a significant problem in a protection system, where the impedance seen by the distance relay oscillates due to the swings in the voltage and current in the transmission line. When power swing goes into the operating zone, the relay may unnecessarily trip [9]. The issues of the transmission system with parallel lines increase due to the mutual coupling, back-feed, in-feed, and poor discrimination between the faulty and healthy lines. These issues affect the distance protection especially in the case of fault occurrence near the far end bus [10,11]. Several solutions have been proposed to solve the problems of parallel lines protection [12–14]. The authors of References [12,13] proposed methods to protect parallel transmission lines using wavelet transform by employing its magnificent characteristics to detect the disturbances in the current signals and to estimate the phasors of all signals as well as to achieve high-speed relaying. In Reference [14], the authors proposed an adaptive distance protection based on the information surrounding the protected line under different operating conditions. The impact of flexible AC transmission system (FACTS) on protective devices, such as distance relays, in the transmission line has

been shown. The FACTS devices in transmission lines enhance the power transfer capability of the line, while causing serious problems for distance protection of transmission lines [15,16]. The transformer inrush current influences protective relays. The inrush currents lead to the maloperation of transformer differential relays [17,18]. The early solution to avoid the maloperation of differential relays is to delay the relay operation [19]. Reference [20] presented a differential relay with only harmonic restraint for bus protection. Modern transformer differential relays use either harmonic restraint or blocking methods [21]. These methods ensure relay security for a very high percentage of inrush and over-excitation cases. The method is not useful with very low harmonic content in the operating current.

Distribution system: In recent years, the structure of distribution networks has changed with the diversification of consumers and technological breakthroughs. Therefore, protection issues of distribution networks have increased. High impedance fault (HIF) is one of the challenges in a distribution network. High impedance faults in distribution feeders cause abnormal electrical conditions that cannot be detected by a typical protection system because of low fault current and high impedance at the fault point [22]. Moreover, failing to detect an HIF may cause fire hazards and risk to human life [23–25]. Various solutions have been presented to detect HIFs. Chakraborty and Das [23] presented an HIF detection method with several even harmonics existing in voltage waveforms. The authors of Reference [24] used a method with a systematic design of feature extraction based on the HIF detection and classification method. A discrete wavelet transform has been proposed for HIF detection along with frequency range and RMS conversion to implement a pattern recognition-based detection algorithm [26].

A set of interconnected loads and DGs within clearly defined electrical boundaries that act as a single controllable entity can be operated in both grid-connected and islanded modes [28]. The increase in the cost of energy delivery from power plants to consumers and the need for improving system reliability and environmental benefits justify the movement towards DG technologies [29]. In existing protection methods, a microgrid can cause many challenges in terms of the protection of blinding zones, false tripping of protective relays, decreasing fault levels, islanding, and auto-reclosers [30–32]. Figure 2 depicts a typical model of a microgrid that is connected to the grid at the point of common coupling (PCC).

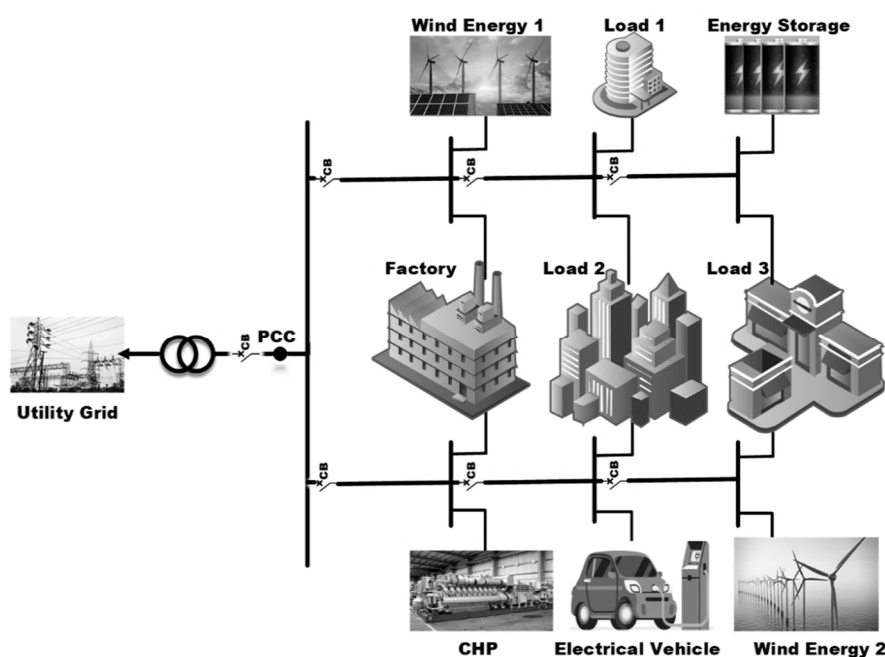

Figure 2. Single line diagram of a microgrid connected to the grid; CHP: combined heat and power CB: circuit breaker.

Microgrids are very diverse concerning their connection, protection, communication, DC/AC system, type of DG, etc. The authors of Reference [33] divided microgrids into three types with different operation modes including facility microgrids, remote microgrids, and utility microgrids. Facility microgrids operate in intentional or unintentional islanded mode, remote microgrids only include the islanded mode and utility microgrids operate in grid-connected mode. Additionally, facility and utility microgrids have utility connections modes contrary to remote microgrids. Remote microgrids are mainly used in distant areas, islands, and large geographically spans. The authors of Reference [34] investigated two types of DGs, i.e., a typical rotating synchronous machine and an inverter-based DG. The main reason for this classification is the difference between the short circuit current level and AC/DC voltage. A remote microgrid spans a larger geographical area compared to facility and utility microgrids. The authors of Reference [35] classified microgrids into three main categories depending on the connection to AC or DC buses, i.e., a microgrid can be AC, DC, or hybrid AC/DC. These researchers addressed the advantages and disadvantages of AC and DC systems. Most power system components, such as loads and transmission lines, work with AC systems. The authors of Reference [36] compared the fault current characteristics of AC and DC distribution systems in the presence of DGs. They investigated the differences among the protection schemes in AC/DC systems and found that the AC short circuit current has a sinusoidal waveform with two zero-crossing in each period including a fault impedance value and a high-raising-rate current. In Reference [35], the disadvantages of AC systems are presented in terms of DGs synchronization, power quality, and three-phase unbalance. Some of the advantages of DC systems are higher efficiency, no power factor losses, and low voltage level as well as no need for inverters and transformer. In addition, the nature of DC power facilitates exploiting renewable resources and supplying DC loads. A hybrid microgrid facilitates the direct integration of both AC- and DC-based DGs in the same distribution network. Reference [37] has proposed a fault analysis method based on a simplified model of AC/DC hybrid microgrid system. The method used a mathematical model equivalent simplification for the analysis of the characteristic system under fault conditions. Figure 3 shows a hybrid structure with both AC and DC microgrids.

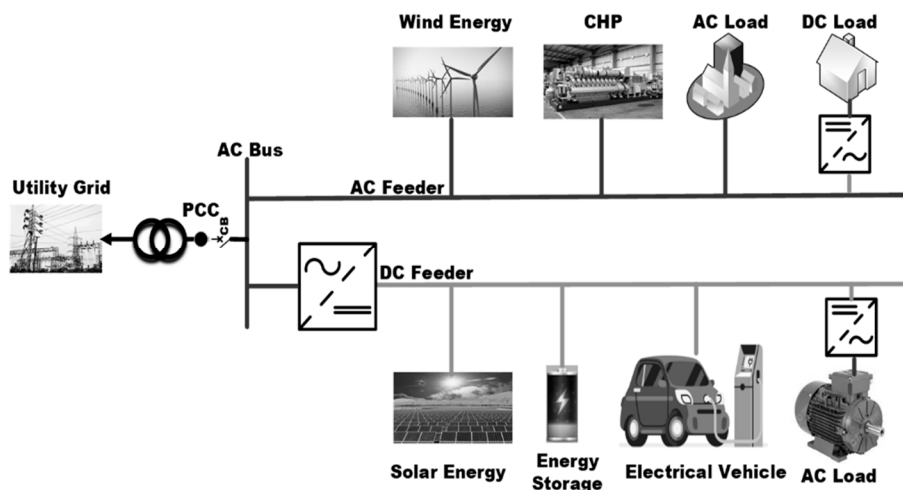

Figure 3. A hybrid microgrid (AC and DC systems).

A smart grid provides an optimal way of distributing electricity from various sources of generation plants and DGs. The goals of employing a smart grid in the power system are as follows:

- involving individuals as an integral part of the power system, consumers or electricity providers;
- using more renewable energy;
- decreasing the dependency on electricity generation from power plants;
- decreasing complete blackouts;

- boosting the power system capacity to supply electricity;
- reducing the time to restore the power system after fault occurrence;
- peak shaving [38].

There have been several discussions on the protection of microgrids, each of them has focused on different issues. In Reference [36], the authors present a detailed technical overview of microgrids and smart grids in light of present developments and future trends. They described the functions of smart grid components that include smart device interface components, advanced forecasting, control of generation/storage units, data transmission/monitoring, power flow, and energy management. Reference [37] analyzed the fault current characteristics in AC and DC distribution systems, first, then it describes the protection methods for AC and DC systems, and, finally, it compares the protection methods in AC and DC networks. Reference [39] presented a review on issues and approaches for microgrid protection. This reference focused on microgrid control including centralized and decentralized controls. Reference [40] reviewed the adaptive protection methods for microgrids. It presented different methodologies of adaptive protection systems with microgrids. A review on the protection schemes and coordination techniques in microgrid systems on presented in Reference [41]. This reference concentrated on protection coordination techniques in microgrids, such as coordination using time–current discrimination using the particle swarm optimization (PSO) algorithm and a modified PSO optimization algorithm.

In the present review, in addition to extending the mentioned works, the authors try to address new challenges, such as blinding zones, and future trends in protection systems. In doing so, first, the protection problems of a power system (generator, transmission line, and distribution system), especially the challenges with the advent of distributed generation networks, are discussed. As a reminder, some of these problems still exist in networks and suitable solutions need to be discussed. Then, the classification of microgrids is briefly discussed. Some problems are expressed in different ways). The last section of the paper describes future real protection systems consisting of wide-area protection and adaptive systems. Wide-area protection is based on measurements that are obtained from phasor measurement unit (PMU) and intelligence protection systems can solve many issues related to the protection systems of the future. Moreover, the wide-area protection with different data transfer processes, including remote terminal unit (RTU), supervisory control and data acquisition (SCADA), energy management systems (EMS), PMU, are reviewed.

The rest of the paper is organized as follows. Section 2 explains the issues that may occur in a power system after adding DGs and microgrids. Section 3 discusses different methods of solving the protection issues in the presence of DGs. Section 4 proposes the future trends in protection schemes regarding wide-area protection (WAP) and intelligent algorithms. Finally, the conclusion is presented in Section 5.

2. DG and Microgrid Challenges

Despite the numerous advantages of the presence of DGs or microgrids in the power system from an environmental and economic point of view, there are also negative impacts on the power system. The major challenge of distributed sources is their effects on the protection system. The presence of a DG changes the structure and the electrical parameters in the distribution network. Traditional structures of distribution networks are radial and, therefore, the protection system is designed for a radial scheme. Adding a DG leads to a change in the direction of the current and looped structure in the distribution system. Additionally, fault current levels may change by embedding a DG [42]. This may lead to a loss of protection coordination. Consequently, the conventional protection schemes are not sufficient to protect power systems [43,44]. In addition, the distribution networks with the high penetration of DG are operated connected and isolated from the grid. Reference [43] proposed the hardware-in-the-loop (HIL) adaptive protection scheme (APS) to solve the protection challenges of DGs. This method is based on the optimal calculation of relay setting groups with online self-adjustment. A novel method has been presented in Reference [44] to detect faults with HIFs.

Reference [45] discussed various protection challenges and schemes in microgrids. The microgrid should be operated in both grid-connected and islanded modes, and the protection system should be able to disconnect the microgrid from the grid as fast as possible. The adaptive protection scheme with digital relays and advanced communication is the most successful scheme of microgrid protection.

2.1. Blinding Zones

Current-based relays (overcurrent (OC) and earth fault (EF)) are the main protection devices in conventional distribution networks. The blinding zone is an area, where the fault cannot be detected by current-based relays. The short circuit current seen by the feeder OC relay is reduced due to the contribution of DG when the distributed energy resources are placed between the fault point and the OC relay. Figure 4 shows the possible blinding zones in the distribution network in the presence of a DG. More possible blinding zones may occur by a DG that is embedded between the feeding substation and the fault point. As shown in the figure, the blinding points occur when the total current is divided among different feeding sources. The short-circuit current at each fault point includes the feeder current and the DG current as shown in Equation (1) [30,39]:

$$I_{Sc} = I_{fault,Feeder} + I_{fault,DG} \tag{1}$$

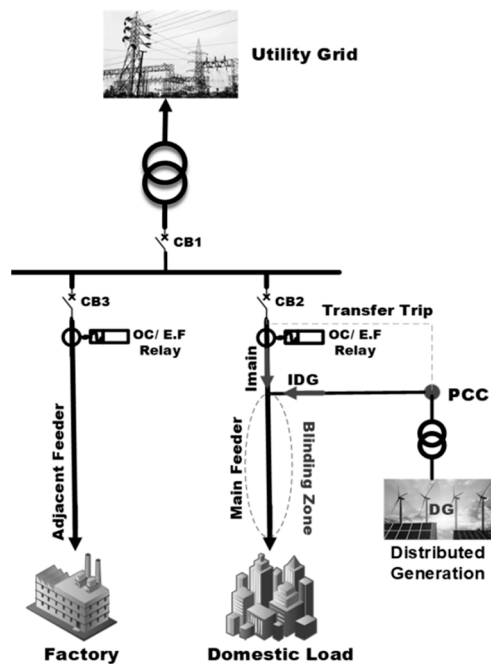

Figure 4. Possible blinding zones in a typical distribution network.

Of course, the type, location, and capacity of the DG are important for distinguishing the blinding points. Various distribution sources have different short circuit levels, which vary depending on whether the DG is inverter-based (photovoltaic source) or synchronous generator (CHP generators) and operates in grid-connected or islanded modes [46].

In other words, an OC relay cannot pick-up in blind zones. Figure 5 illustrates the operation and blinding zones by the characteristic curve of the OC relay (pick-up current was 400A [30]). Many researchers have tried to improve the performance of OC relays in blind zones. The change in settings is the conventional method to protect the distribution network in blind zones. Reference [30] investigated the recloser effect on covering the blinding zones and improving the reliability in a real distribution network. A recloser relay in a suitable location can also detect high impedance faults.

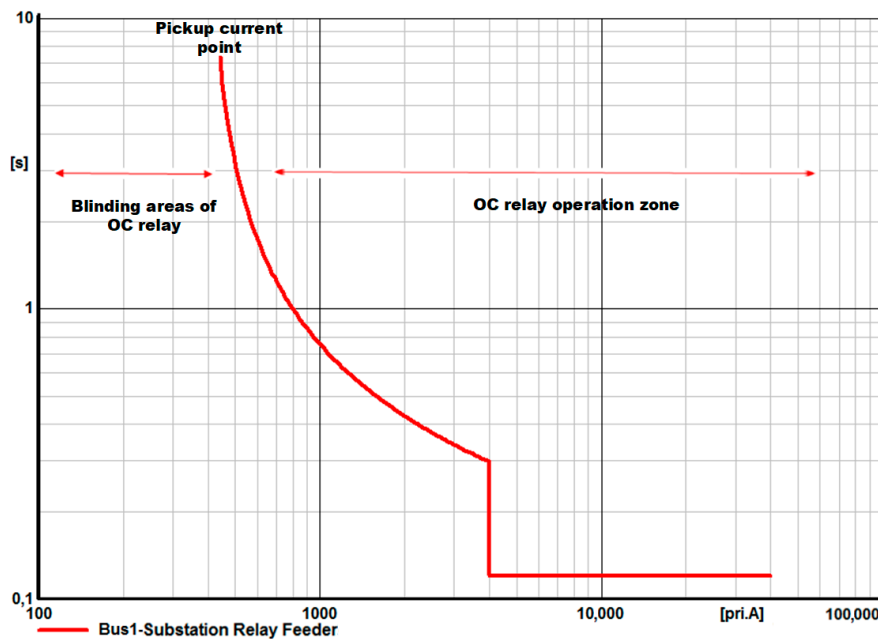

Figure 5. Characteristic curve of the overcurrent (OC) relay operation zone and blinding zones.

The high penetration of DG may result in underreaching or overreaching problems of distance relays in distribution systems. A distance relay is less sensitive to changes in power system topology comparing to an OC relay [27]. The distance relay setting has a definite time for any fault in the transmission line or a distribution feeder. It may not operate according to the zone setting in the presence of a DG. The measured impedance of the line changes with high penetration of the DG.

2.2. Sympathetic or False Tripping

The high penetration of various sources may change the flow of the fault current in the radial feeder of a distribution network. A traditional AC distribution system has a radial topology with a non-directional OC relay. Non-directional OC relays cannot determine the change in fault current direction, and this causes an unwanted trip in the main feeder [47,48]. Reference [47] proposed DOC relays to protect radial distribution networks in the presence of DGs. The DOC settings are divided into OC and directional elements. A DOC relay restricts the relay maloperation due to the short circuit occurring on the adjacent feeders. The DOC element settings consist of the fault direction (forward and backward), maximum torque angle, and polarizing quantity (voltage and current). A method has been proposed in Reference [48] to avoid sympathetic tripping of non-DOC relays in the distribution network with an embedded DG. This method is offline to overcome false tripping issues and uses a genetic algorithm and a linear programming to access optimal responses. In Reference [49], a method was proposed for utilizing single-setting and dual-setting DOC relays with a minimum number of two schemes for protection. The interior-point method has been used for the optimization problem and solving the protection coordination problem. Reference [50] suggested a novel quaternary protection scheme with dual-DOC relays to protect microgrids. This scheme uses a centralized protection control strategy that can re-adjust the optimal relay setting automatically with computational intelligence optimization. Reference [51] presented a protection method in inverter-based microgrids by comparing a current-only polarity between the pre-fault current and the fault current components. The detection of fault is based on the angle difference between the pre-fault current and fault current components.

Figure 6 depicts the basic principle of false tripping in the main feeder (DGs feeder) due to a fault on the adjacent feeder. As shown in the figure, the main feeder relay may operate by a fault on the adjacent feeder.

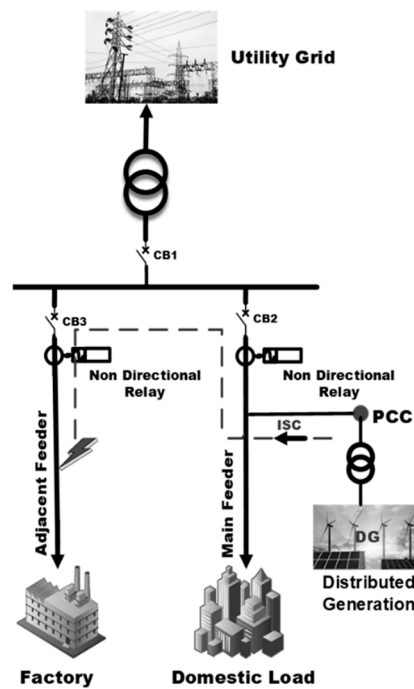

Figure 6. Sympathetic tripping of adjacent feeder in the presence of DG.

A DOC relay was proposed as the best solution to avoid the sympathetic tripping in the presence of DG in multi-loop systems [47,48].

2.3. Islanding Problems

A microgrid with high penetration of DGs and interconnected loads can be operated in grid-connected and islanded mode [52]. Based on the Institute of Electrical and Electronics Engineers (IEEE) standard 1547, the DG should be isolated upon the occurrence of any type of fault in the grid [53]. As the main advantage, islanded mode enables the microgrid to inject energy to the local loads to enhance the reliability of the power system. However, in such a system, the protection and control of the microgrid during grid-connected and islanded modes are very complicated [54]. Overcurrent relays as the main protection device in radial distribution are not adequate to protect the microgrid in islanded mode [55].

2.4. Recloser–Fuse Problems

Reclosers and fuses are the main protective devices that are used to protect distribution systems against faults. Reclosers are utilized to clear temporary faults in the main feeders, while fuses are used to protect the system against permanent faults in lateral feeders. The presence of DGs may increase the fault current in distribution systems, so this presence may cause abnormality and miscoordination of reclosers and fuses [56,57].

DGs may affect the recloser performance in two ways: loss of coordination between the fuse and recloser or reducing recloser sensitivity. Moreover, the presence of a DG may influence the recloser pick-up sensitivity [58]. Figure 7 illustrates the design of DG and recloser placement in the distribution network.

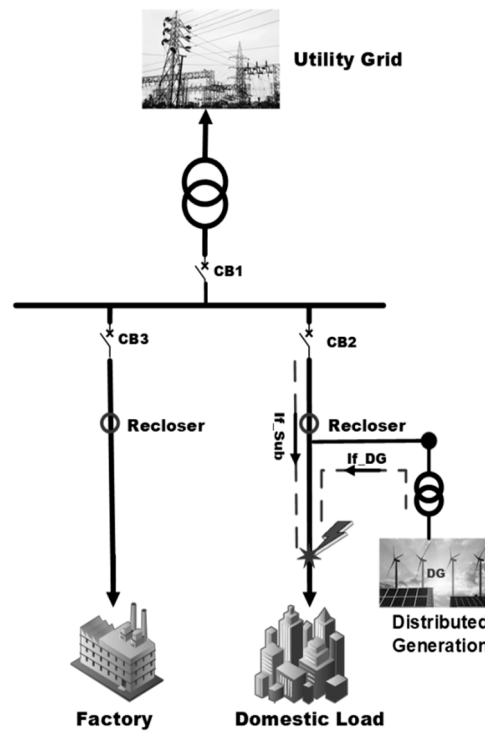

Figure 7. Recloser coordination in the presence of DG.

2.5. Sensitivity and Response Time

A microgrid has a very fast response time and low system inertia, especially in islanded mode. This is due to the lack of high reserves in DG sources, especially reactive power. A protection system must be able to detect quickly and accurately, as small disturbances cause catastrophic consequences in the system [59].

2.6. Variation of Short Circuit Level

Short circuit current is a significant factor in determining and protecting the equipment in a power system. Short circuit current increases with DG penetration in the power system. The short circuit level depends on the type and operation mode of DGs. The fault level is different in synchronous generators and inverter-based DGs. The maximum fault current of an inverter-based DG is not more than twice the inverter-rated current [42,60]. The synchronous machine-based DGs can generate fault currents that are 4 to 10 times greater than inverter-based DGs [61]. The variation of short circuit level is reflected in traditional protective devices, such as fuses and OC relays. Inverter-based DGs may cause trip failure in protective devices [42]. Additionally, the short circuit levels in grid-connected microgrids are greater than islanded ones [40]. In the islanded mode, some DGs have limited short circuit capabilities that are not adequate to be detected by the protective devices. Of course, the variations in the short circuit can affect the relay operating time, especially indefinite time sections, for example, in OC and distance relays. A fault current limiter (FCL) is implemented to limit the fault current values [62].

In [63], several methods have been proposed to reduce the negative effects of DGs as follows:

- Modifying or changing the protection scheme;
- Installing FCL;
- Restricting DG capacity;
- Isolating the DG from the power system immediately after detecting the fault;
- Using an adaptive protection.

3. Protection Scheme of Microgrid

The coordination of traditional protection relays as standalone units with fixed settings is based on the operating time of the primary and backup protection (Figure 8) [64–66]. This scheme of power system protection cannot adapt to the changes in topology and operation mode. Reports have indicated that the conventional protection schemes have a main role in major blackouts of power systems [67]. Therefore, the demand and structure of the distribution network as well as the nature of the distribution system have changed with the high penetration of DGs.

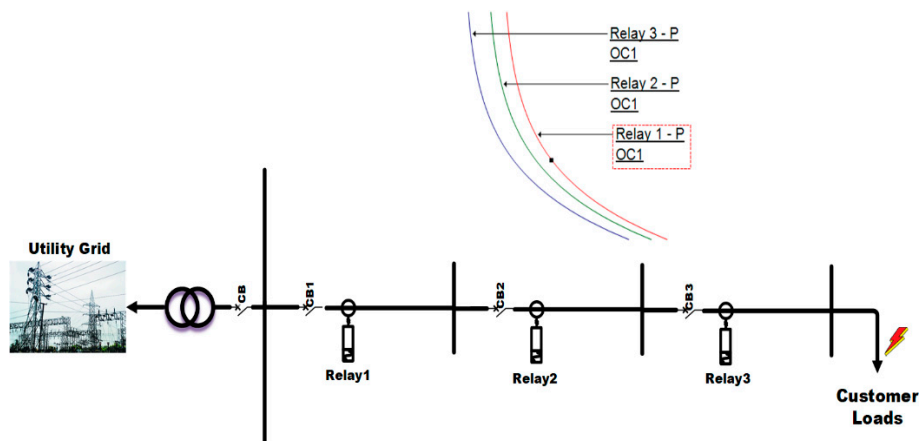

Figure 8. Traditional coordination of protective relays.

The major challenges of the distribution network are associated with the changes in the nature of the microgrid. Many schemes have been proposed to protect the distribution network with high penetration of resources.

3.1. Modifications of Scheme

Embedded various distributed resources in traditional distribution networks cause problems in the protection system. There are several simple solutions to improve the conventional structure of distribution networks such as changing relay settings and using DOC relays.

3.1.1. Changing Relay Settings or Relay Type

The simple solution to protect against changes in the power system topology is the readjustment of the protective relay settings. In blinding zones, the relay cannot pick-up the fault and these zones can be covered by increasing the sensitivity of the relay through reducing the pickup current value. It should be noted that changing relay setting may cause problems in the protection coordination [29,55]. In Reference [68], a method of microgrid protection has been proposed by using low voltage ride through (LVRT) operation. The protective relay setting values have been corrected in the outcome of the simulation results. Reference [69] has presented an improved OC protective relay based on the compound fault acceleration factor and the beetle antennae search (BAS) optimization in microgrids. The method has enhanced the speed of the OC protection and the coordination between the primary and backup relays.

A DOC relay has been proposed to protect the DG feeder from sympathetic tripping as a result of fault on the adjacent feeder [46]. In particular, the DOC relay is required to prevent the unwanted tripping in neighboring feeders [55]. Modern protective relays are digital and multifunctional with the capability of activating multiple protections simultaneously.

3.1.2. Fault Current Limiter

A fault current limiter is a series device used to limit the fault current and does nothing in normal operation; fast action is needed to limit the short circuit current level using a preset value by inserting a series of high impedance values under fault condition [62]. Several FCL technologies and applications have been reported in References [70,71]. The FCLs have been classified into four groups: the superconducting FCLs (SFCLs), solid-state FCLs (SSFCLs), hybrid FCLs (HFCLs), and other technologies [72]. Figure 9 shows the classification of different types of FCL.

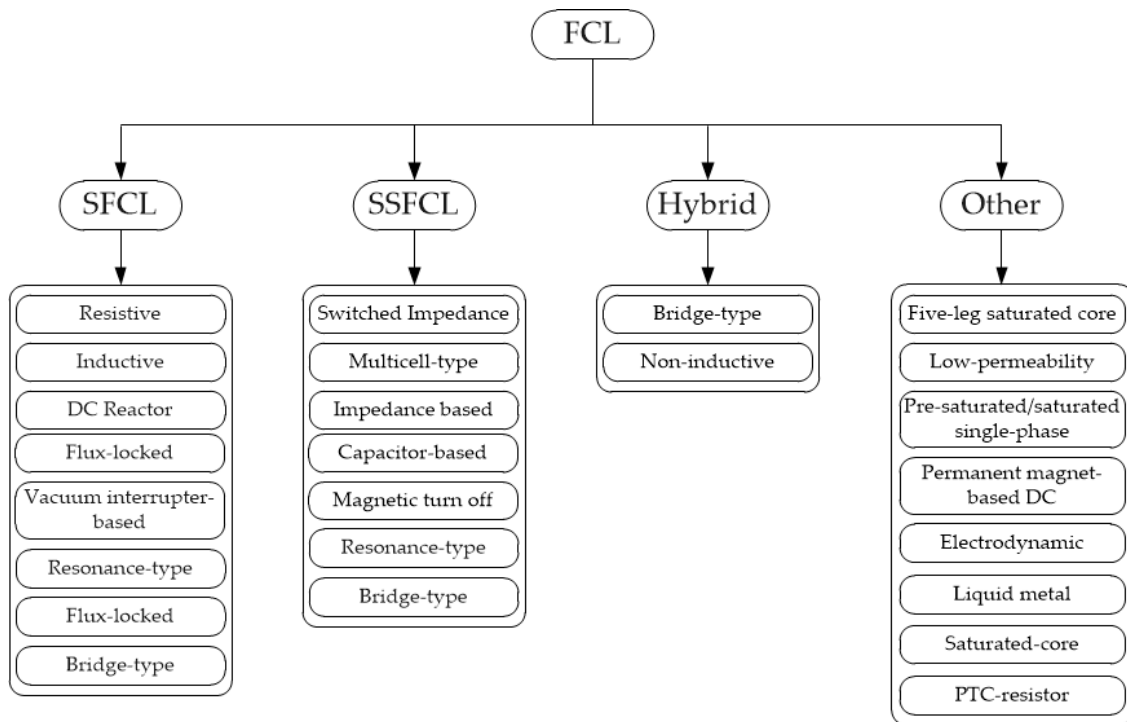

Figure 9. Classification of different types of FCLs [72].

Inductive FCLs have superior performance and higher operation speed than other FCLs [73]. Inductive and resistive FCLs are examined to limit the current drawn from DGs during a fault somewhere in the power system. An FCL was implemented at the beginning of a radial distribution feeder equipped with a DG [62]. In Reference [58], a solution was presented using FCLs to restore the relay coordination in looped distribution networks. Figure 10 shows a fault current limiter in the distribution network with a DG.

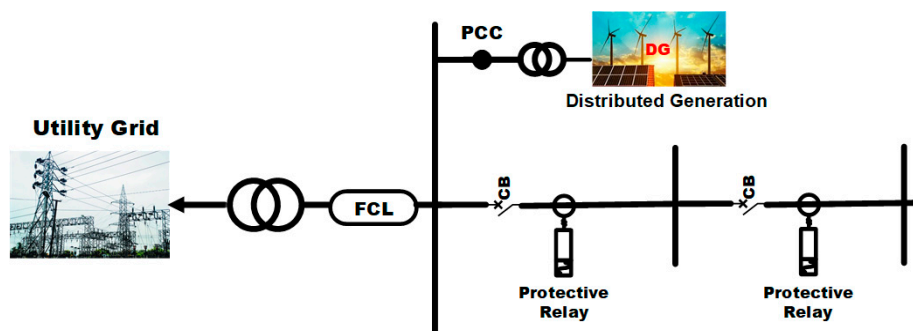

Figure 10. Fault current limiter–DG system interconnection.

3.2. Impedance-Based Protection Method

An impedance-based protection method protects a distribution network in the presence of DGs. Fault location is estimated by the impedance method based on the measurement of voltage and current at the relay point or at the two ends of the line [74,75]. A distance relay is a protective device that measures the impedance of a line using the voltage and current at the relay point. Distance protection does not normally need communication among relays [74,76]. Reference [76] described the efficiency of various types of admittance criteria during high resistance faults. Analog or digital techniques are used to realize admittance-type protections. The admittance-type protection can be used under the damaged or switched-off resistor conditions. Moreover, admittance-based protection can be widely used in resistor-grounded networks. The authors of Reference [77] studied a distance protection scheme for detecting and protecting both islanded and grid-connected microgrids. Distance relays can clear faults quickly, thereby facilitate maintaining the stability of the system during contingencies. Figure 11 shows different zones of distance relays. Distance relays usually cover three zones (zone 1, zone 2 and zone 3). Zone 1 of a distance relay commonly covers 80% of the protected line and operates without delay. The other two zones (zones 2 and 3) are overreaching zones with time delay. Zone 2 of a distance relay is usually designed to cover the protected line plus 50% of the shortest adjacent line or 120 percent of the protected line, whichever is greater. Zone 3 provides a backup protection for zones 1 and 2 of unclear faults in the adjacent sections [78].

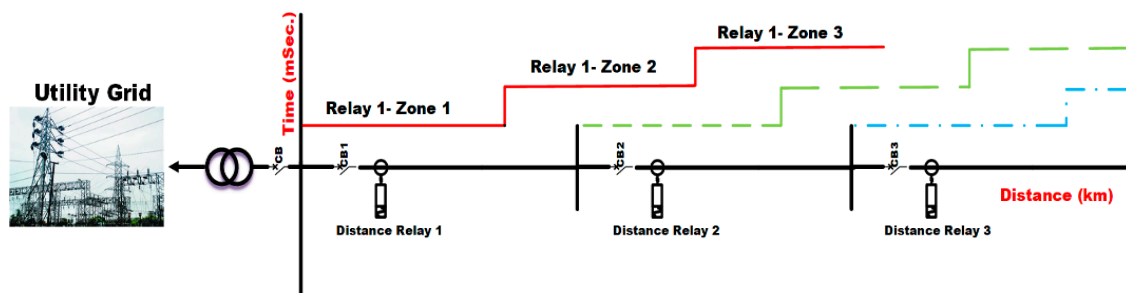

Figure 11. The zones of distance protective relays.

The authors of Reference [79] studied distance relays using the wavelet transform (WT) method for detecting faults. The analysis of wavelet is widely used for signal processing that can be applied effectively to overcome difficulties of the traveling wave protection techniques. The WT method is a novel signal processing technique developed from the Fourier transform (FT) [80,81].

A dyadic wavelet transform was used in Reference [80] for investigating transmission line protection. The discrete approximation factor of dyadic wavelet transform with Haar wavelet is used as an index for detecting the transmission line faults. The proposed algorithm technique uses a moving data window. Reference [81] presented a new wavelet transform based on fault detection. This fault detection method utilizes artificial neural networks (ANNs) to accurately approximate decomposition of phase voltages and current samples. In Reference [82], a microgrid protection scheme was proposed based on the autocorrelation of three-phase current envelopes by using the squaring and low-pass filtering techniques. The protection method included fault detection, fault direction, fault zone identification, fault classification, and tripping units. This method provides the coordination of the primary and backup protection. In Reference [83], a hybrid method was presented to detect ground fault in the blinding zones. The approach consisted of detailed coefficients of discrete wavelet transform (DWT) using a pulsation signal generator injection in an ungrounded low voltage direct current (LVDC) microgrid. The WT method is based on transformation from the time domain into the time-frequency domain. Fault location method uses two different ways based on the existing communication scheme, a single-ended method, and a double-ended method. A single end fault location scheme is also possible when the current and voltage transients are available at the relaying

point. In the double-ended method, the fault is recorded simultaneously at both ends of the line by two separate channels [75,84–86].

The impedance method is the most known main-frequency component-based method. This method can calculate the fault location without requiring any especial hardware/software by obtaining data [87]. The authors of [88] improved the impedance-based fault location by using a short-distributed line model. The high penetration of DGs changes the short circuit current level. The low fault current in inverter-based microgrids is mainly due to the inverter's controller and not due to the power system's impedance. Elkhatib and Ellis [89] studied an impedance-based pilot protection scheme. Their proposed protection scheme employed communication between relays or, in general, between relays of the same protection zone to locate the fault. The relay feeder was equipped with an impedance element to detect a fault with a directional element that determines the direction of the fault. The communication-assisted impedance-based protection scheme was proposed for inverter-dominated microgrids. Consequently, the vast literature and extensive existing experiences in designing impedance and directional elements can be utilized in designing these protection elements [90,91]. Different pilot protection logics can be used to determine the location of faults. Nunes and Bretas [92] investigated the fault location in an unbalanced DG system using an impedance-based method. Reference [93] proposed an efficient protection scheme for a DC microgrid with high penetration of constant power loads (CPLs). This method exploits the fault location scheme strategy using the transient behavior of the first-order derivatives of fault current; in addition, it utilizes pre-fault data for fault location in the CPL line and for detecting high- and low-resistance faults in dc microgrids. In Reference [94], a microgrid protection and control scheme has been proposed in synchronous islanded mode using the PCC breaker relays, battery energy storage system (BESS) inverter controller, and remote input/output mirror bits based communications approach (85RIO). Figure 12 shows the impedance-based protection scheme with various distributed resources.

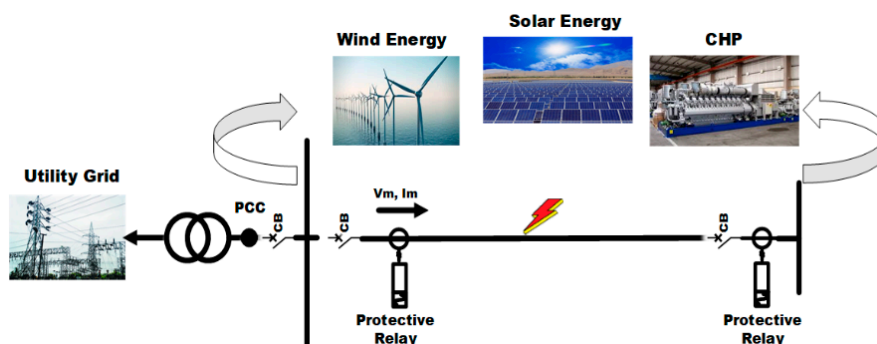

Figure 12. Impedance-based protection scheme.

3.3. Differential-Based Protection Method

Differential protection is another common method to protect transmission lines and transformers in power systems [74,95,96]. The principle of differential relay operation is based on using the imbalance current flow into and out of a specific protected zone. The differential-based protection method is mainly utilized to detect low short circuit current in the islanded microgrid. The method cannot be used as a complete protection scheme and is more suited to detect downstream earth faults, while some other techniques have to be taken into account to identify further faults like upstream ground faults, line-to-line (L–L) faults, and symmetrical faults. The method also utilizes communication links for differential operation [40]. Figure 13 depicts the differential-based protection scheme of a microgrid with a communication channel.

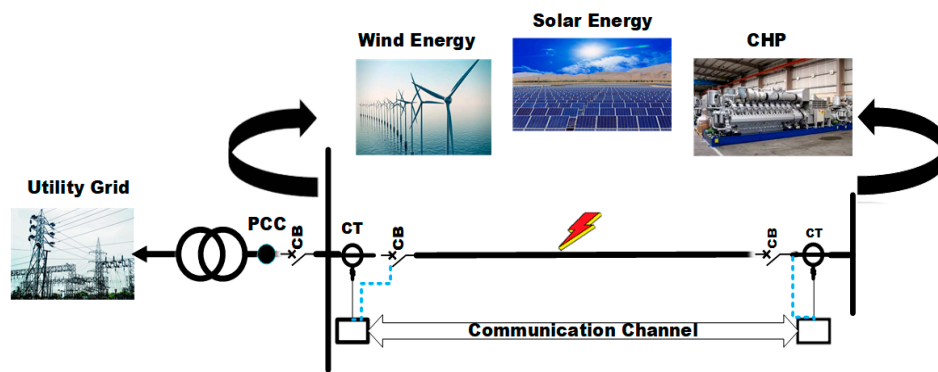

Figure 13. Differential-based protection scheme.

Normally, this scheme has the best selectivity since it depends on the communication between the beginning and the end of the protected line segment [74]. The authors of Reference [97] investigated an adaptive wide-area current differential protection system. The method divides the power system into different protection zones that are dynamically online. The protection system adaptively changes with the topological variations of the power system. References [42,44] proposed the protection of a microgrid with a communication network using digital relays. These methods use differential protection for low fault currents, such as in an HIF and inverter-based-microgrid. In Reference [98], a communication-assisted OC protection scheme was proposed for PV in DC microgrids. This method is based on differential protection, which is used as the backup protection. The protection scheme in grid-connected and islanded operation mode of a DC microgrid uses OC relays. Otherwise, a protection scheme has been suggested based on differential protection. Reference [99] has presented a protection scheme in the loop distribution system in the presence of DGs. This method is based on the equivalent circuit of the distribution system and uses a control center with high-speed communication as the centralized protection scheme.

3.4. Harmonic Current

The high penetration of converter-based distributed generation has increased harmonics levels in microgrid topologies. The power system harmonics depend on the topology of the network as well as the source of harmonic interactions [100,101]. Modern relays can monitor total harmonic distortion (THD) of the inverter terminal, which can control the system concerning the harmonic changes. The harmonic content method is mainly designed to protect the DG rather than the power system [101]. The relationship between stability and harmonic importance of the microgrid has been studied in [102,103]. The harmonic impedance is a key factor in assessing harmonic emission levels in electrical power systems. Reference [102] proposed a new measurement technique by a complex data-based least-square regression, combined with two techniques of data selection. The method takes into account two techniques of data selection. The two kinds of data-selection methods can be used together to cross-check the results of each other. The control strategies of inverter operation in a different mode has been suggested in Reference [103] in which each component of the microgrid harmonic is determined. In this method, the harmonic impedance is measured by injecting a current disturbance.

Al-Nasseri and Redfern [104] presented a new type of protection scheme for microgrids based on the harmonics content of the inverter output voltage. Their method can protect against faults that are both internal and external to the protection zone. The method uses the Fourier transform (FFT) and THD. In Reference [105], a new high-frequency protection relay has been proposed to detect and isolate the fault by injecting harmonic signals. According to the strategy of harmonic injection, only one DG takes responsibility for the activation of the corresponding relay. As a result, the relays behave like directional relays. The main advantage of this method is that the resultant directional relays do not need any voltage transformer to detect direction of the fault. Therefore, it is a cost-effective solution for microgrid protection.

3.5. Voltage-Based Scheme

The voltage-based method is another approach to protect microgrids using voltage measurements [106]. The method uses the voltage level gradient through the power system during faults and is often applied as a backup protection scheme [86,107]. The authors of Reference [106] implemented the voltage-based protection scheme in combination with directional elements to develop a protection scheme for low fault and low voltage radial microgrids. Several research works have described the abc–dq transformation to detect voltage disturbances. The method converts the signals from abc reference to a dq frame [108,109]. The output voltages of micro-source are transformed into DC quantities by the dq reference frame. Any disturbance at the micro-source output due to the fault on the grid is reflected as disturbances in the dq values [108]. The authors of Reference [108] suggested a protection scheme based on the abc–dq transformation of the voltage waveforms to detect faults in a microgrid. The proposed method can protect both internal and external faults in a set zone of protection associated with the microgrid.

Redfern and H. AL-Nasseri [110] presented the voltage-based protection method in a dq rotating frame in islanded microgrids. Their method presents a variety of faults in a three-phase power system and a voltage-based protection scheme monitoring the voltages seen at the converter's terminals. The principles of this scheme can be applied to both single-phase and three-phase generators. It should also be noted that determining the fault location based on voltage measurements is extremely difficult due to the magnitude of the voltage dip during the faults. This is because the voltage magnitude would be the same at different locations [89]. In addition, the voltage drop may not be large enough in HIFs. Consequently, the under-voltage protection function may not be able to distinguish a faulty condition from a power system overload [55].

3.6. Adaptive Protection

The protection system cannot protect the power system against widespread changes. An adaptive protection scheme can change the relay setting/protection requirement according to the new prevailing conditions such as operational or topological changes [111–114]. The power system protection is improved, and system security is enhanced by following adaptive protection philosophy. The adaptive protection schemes are more effective for the protection of such a power system [46]. Adaptive protection is “an online activity that modifies the preferred protective response to a change in system conditions or requirements in a timely manner using externally generated signals or control action”. Adaptive protection has been developed since the 1980s [61]. An adaptive protection scheme solves the problem of both grid-connected and islanded modes of operation [115]. In an adaptive protection system, there is an automatic readjustment of relay settings, when microgrid mode changes from grid-connected to islanded and from islanded to grid-connected.

The authors of References [116,117] investigated an adaptive OC-based microgrid protection scheme that only considers synchronous generators and lacks HIF detection. The authors of Reference [118] used an adaptive protection only for a power system with synchronous generators that have a significant fault current contribution. The proposed method is unable to detect a single-phase fault and every fault type.

References [43,119,120] have proposed a method using communication-assisted adaptive protection schemes. This method is used for looped/meshed distribution systems with DG penetration. The method is based on each DOC relays of the setting group in advance using optimization algorithms. Reference [118] also used adaptive schemes that include two sets of relay settings, one for the grid-connected and the other for islanded mode. This adaptive scheme determines the relay communication protocol/communication infrastructure for interacting among the relays and master controller. The relays update the settings with the master controller that senses the topology of the microgrid and communicates [46,118]. Reference [111] proposed an adaptive multi-stage OC relay protection scheme in the presence of DGs in the distribution network. The adaptive DOC relay coordination was performed using the ant colony optimization (ACO) and genetic algorithm (GA) [112].

In Reference [113], an adaptive protection coordination scheme has been proposed for numerical DOC relays by using the commercial AMPL (a mathematical programming Language)-based IPOPT (interior point optimization) solver.

An adaptive protection system was studied in References [67,114] using the optimal coordination of OC relays. The method is divided into two separate parts: an adaptive protection device and an adaptive protection system. The device, in general, uses actual data and can adapt to the changes in the processing mode for certain zones. The adaptive protection scheme based on GPS in the distribution network with high penetration of DGs is presented in References [29,41,121]. The distribution network was divided into several zone breakers according to a reasonable balance of DGs and local loads.

Tables 1–3 list the classification of different items of the review. Nowadays, different protection schemes are increasingly used in the real world. Table 1 presents the items in the literature for the protection of microgrids including the type of DGs, protection scheme, protective relay, the simulation situation (including simulation of a real network or simulation of a test case), and the year of publication. Some protection schemes in the table have been implemented in the real world, and their simulation and experimental results are given in the paper. A comparison between simulation and experimental results confirms the research quality. The empirical results are according to real-time conformity. For instance, the protection scheme and the type of the relays and DGs are completely similar in References [30,120], while the former implemented a real network and the latter simulated a test case. The empirical results are according to real-time conformity.

Table 1. Classification of different items used in microgrid protection schemes in the literature.

Refs.	Published Year	DG Presence	Protection Scheme	Real/Simulation	Protective Relay
[75]	2003	Without DG	Impedance Based	Real	Current and Voltage
[29]	2004	DG	Adaptive	Simulation	Fuse and Recloser
[108]	2006	Inverter Based	Voltage Based	Simulation	Voltage
[62]	2008	DG	Modification	Simulation	DOC
[104]	2008	Inverter Based	Harmonic Based	Simulation	IDM
[44]	2010	SE/WT	Differential Based	Real	Differential
[64]	2010	SM Based	Adaptive	Simulation	Current Based
[66]	2010	SM Based	Adaptive	Simulation	Current Based
[92]	2011	SM Based	Impedance Based	Real	Distance
[106]	2011	SM and Inverter Based	Modification	Real	OC
[55]	2012	Inverter Based	Modification	Real	Current and Voltage
[103]	2012	Inverter Based	Harmonic Based	Simulation	Current Based
[27]	2013	DG	Impedance Based	Real	Distance
[42]	2014	Inverter Based	Differential Based	Simulation	Differential
[57]	2014	DG	Adaptive	Real	Fuse and Recloser
[101]	2014	Inverter Based	Harmonic based	Real	IDM
[86]	2014	Inverter Based	Adaptive	Simulation	Current
[43]	2015	DG	Adaptive	Simulation	DOC
[56]	2015	DG	Modification	Real	Fuse and Recloser
[74]	2015	SM Based and WT	Impedance Based	Real	Distance
[111]	2015	SM and Inverter-Based	Adaptive	Simulation	OC
[112]	2015	SM and Inverter Based	Adaptive	Simulation	DOC
[58]	2016	SM Based	Modification	Real	Fuse and Recloser
[89]	2017	Inverter Based	Impedance Based	Simulation	Distance
[120]	2017	SM Based	Adaptive	Simulation	OC
[88]	2018	Inverter Based	Impedance Based	Real	Distance
[105]	2018	Inverter Based	Harmonic Based	Real	DOC

Table 1. Cont.

Refs.	Published Year	DG Presence	Protection Scheme	Real/Simulation	Protective Relay
[113]	2018	DG	Adaptive	Simulation	DOC
[30]	2019	SM Based	Modification	Real	OC
[47]	2019	SM Based	Modification	Real	DOC
[119]	2019	SM and Inverter Based	Adaptive	Real	Current and Voltage
[51]	2019	Inverter Based	Modification	Simulation	Current Based
[98]	2019	Inverter Based	Modification	Simulation	OC
[49]	2020	Inverter Based	Adaptive	Simulation	DOC
[50]	2020	DG	Modification	Simulation	DOC
[68]	2020	SM and Inverter Based	Modification	Real	OC
[69]	2020	DG	Modification	Simulation	OC
[82]	2020	SM and Inverter Based	Modification	Simulation	OC
[83]	2020	Inverter Based	Impedance Based	Simulation	IDM
[93]	2020	Inverter Based	Modification	Real	Current Based
[94]	2020	Inverter Based	Adaptive	Real	IDM
[99]	2020	DG	Adaptive	Simulation	Current Based
[116]	2020	SM and Inverter Based	Adaptive	Simulation	Current and Differential
[122]	2020	DG	Adaptive	Simulation	DOC
[123]	2020	DG	Adaptive	Simulation	DOC

Three-phase (L.L.L), two-phase (L.L), two-phase to-ground (L.L.G), single line-to-ground (L.G). Solar energy (SE), wind turbine (WT), synchronous machine (SM), intelligent device manager (IDM).

The main contributions of the literature are given in Table 2. Important works on different protection schemes from the beginning until now are summarized in Table 2.

Table 2. Classification of important research works in the field of protection systems.

Refs.	Published Year	Main Contribution
A.Y. Abdelaziz et al. [114]	2002	AP scheme by applying an LPT
D.W.P. Thomas et al. [75]	2003	Single-end fault location based on the TW
J.-A. Jiang et al. [80]	2003	Fault location using the dyadic WT with Haar wavelet
S.M. Brahma and A.A. Girgis [29]	2004	AP based on communication and network device data
T.M. Lai et al. [26]	2005	DWT and NNR classification, HIF detection
H. Al-Nasseri et al. [108]	2006	Proposing a method based on the abc-dq transformation
W. El-Khattam and T.S. Sidhu [62]	2008	Coordination of the DOC relay by FCL based on DGs capacity
H. Al-Nasseri and M. Redfern [104]	2008	The FD by using the DFT and THD
E. Sortomme et al. [44]	2010	Using the DS by high-rate sampling of the current
A. Prasai et al. [64]	2010	Multi-level protection based on communication with PLC
H. Wan et al. [66]	2010	Multi-agent protection system based on communication
J.U.N. Nunes and A.S. Bretas [92]	2011	Fault location estimation based on the impedance-based scheme
M.A. Zamani et al. [106]	2011	Proposing a programmable MPRs relay with directional elements in grid-connected and islanded modes without communication
M.A. Zamani et al. [55]	2012	MBP coordination strategy through the communication-assisted
H. Shi et al. [103]	2012	Using harmonic impedance by injecting a current disturbance
M.F. Al_Kababjie et al. [79]	2012	Fault location of distance relay using the Haar WT
A. Sinclair et al. [27]	2013	Setting the distance protection based real event data
S.A.M. Javadian et al. [31]	2013	Analyzing the risk of protection systems operation in the presence of DG
E. Casagrande et al. [42]	2014	Using the DS by the symmetrical component of the current
P.H. Shah and B.R. Bhalja [57]	2014	The adaptive scheme for coordination between recloser-fuse
X. Li et al. [86]	2014	TW using MM technology and multi-end protection scheme
J. Merino et al. [101]	2014	Proposing a passive islanding detection method based on the 5th harmonic voltage magnitude
V. Papaspiliotopoulos et al. [43]	2015	The HIL AP scheme

Table 2. Cont.

Refs.	Published Year	Main Contribution
A. Supannon and P. Jirapong [56]	2015	Using the AAT to suitable coordination of the recloser–fuse
Hengwei Lin et al. [74]	2015	Adopting the distance protection considering infeed current
S. Shen et al. [111]	2015	AP scheme by using Thevenin equivalent parameters
M.Y. Shih et al. [112]	2015	Adaptive PS with ACO and GA
K.A. Wheeler et al. [58]	2016	Algorithm for assessing the fuse-reclose protection coordination
M.E. Elkhatib and A. Ellis [89]	2017	Impedance PS with the CA
E. Purwar et al. [120]	2017	Optimal relay coordination with independent settings
S.H. Mortazavi et al. [24]	2018	Estimating HIF location with time-domain analysis
R. Dashti et al. [88]	2018	Fault locating using current and voltage at the beginning of feeder and DG terminal
S. Beheshtaein et al. [105]	2018	Harmonic-based OC relay by using injecting harmonic signals
M.N. Alam [113]	2018	AP scheme with AMPL based IPOPT solver
Q. Cui et al. [25]	2019	MDL-based algorithm, HIF detection
J. Sahebkar et al. [30]	2019	Adding recloser to protect of the blind areas
A.H. Abdulwahid [38]	2019	FD with WT and avoiding malfunction of differential protection
J. Sahebkar et al. [47]	2019	Using the DOC to avoid the false tripping of the adjacent feeder
B. Wang and L. Jing [51]	2019	Using current-only polarity comparison
A. Shabani and K. Mazlumi [98]	2019	Using communication-assisted in OC protection scheme
A.M. Tsimtsios et al. [119]	2019	The PS based on PnP with the CA, numerical relays
M. Nabab Alam et al. [49]	2020	Using single-setting and dual-setting DOCRs
P. Tharara and P. Jirapong [50]	2020	Using a dual-DOC relay to protect the microgrid
H. Shin et al. [68]	2020	Using OC relay based on LVRT operation and relay settings
L. Ji et al. [69]	2020	Improved OC relay based on compound fault acceleration factor
s. Baloch et al. [82]	2020	Protection scheme based on autocorrelation of current envelopes using the squaring and low-pass filtering technique.
K.-M. Lee and C.-W. Park [83]	2020	Using a hybrid method by pulsating signal generator and DWT in ungrounded LVDC
N. Bayati et al. [93]	2020	Using the fault location scheme of CPL in a dc microgrid
Vukojevic and S. Lukic [94]	2020	Using seamless Transition islanding and grid synchronization in PCC
H.-C. Seo [99]	2020	Using a method based on the equivalent circuit
O.A. Gashteroodkhani et al. [116]	2020	protection technique using Time-time -transform and DBN
S. Saldarriaga-Zuluaga et al. [122]	2020	Using optimal coordination of DOC by GA
S. Saldarriaga-Zuluaga et al. [123]	2020	Using optimal coordination of DOC by GA and multiple options

Minimum Description Length (MDL); Nearest Neighbor Rule (NNR); Fault Detection (FD); Adaptive Protection (AP); Differential Scheme (DS); Automatic Analysis Tool (AAT); Main and Backup Protection (MBP); Power Line Carrier (PLC); Traveling Wave (TW); Mathematical Morphology (MM); Discrete Fourier Transform (DFT); Microgrid Protection Relay (MPR); Linear Programming Technique (LPT); Deep Belief Network (DBN); Plug and Play (PnP); Protection Scheme (PS); Communication-Assisted (CA).

Table 3 lists a summary of the microgrid protection schemes [36,40,41,124].

Table 3. Summary of microgrid protection schemes.

Protection Scheme	Used Devices	Operation Method	Advantages	Disadvantages
Current based (Conventional)	OC	Current symmetrical component	<ul style="list-style-type: none"> • Simple • Inexpensive 	<ul style="list-style-type: none"> • Difficult to coordinate in the meshed distribution system • Problems with unsymmetrical loads due to the single-phase DGs
Current based (Modification)	DOC	Current symmetrical component	<ul style="list-style-type: none"> • Easy to coordinate in the meshed distribution system. • Selective 	<ul style="list-style-type: none"> • More expensive than OC
	FCL	Current transient component	<ul style="list-style-type: none"> • Reduction of the short circuit current 	<ul style="list-style-type: none"> • Costly
Voltage based	UV, OV, UF, and OF	Voltage symmetrical component	<ul style="list-style-type: none"> • Designing load shedding and preventing blackout system 	<ul style="list-style-type: none"> • HIF cannot be detected • Poor accuracy in the grid-connected and varying power systems • Voltage drops can create errors
Impedance based	Distance	Measured impedance with threshold values	<ul style="list-style-type: none"> • Easier than DOC for coordination in the meshed distribution system 	<ul style="list-style-type: none"> • Accuracy affected by harmonics and transients • Errors due to the fault impedance • Not effective with short-range lines
Differential current	Differential	Comparison of input and output current of a zone	<ul style="list-style-type: none"> • High speed and sensitivity • Relatively simple. • High-performance for high impedance fault • Immune to the current flow direction and magnitude variations 	<ul style="list-style-type: none"> • Problems due to the unbalances and transients • Depends on the communication channel
Harmonic content	IEDs device	Voltage components	<ul style="list-style-type: none"> • Used for inverter-based system 	<ul style="list-style-type: none"> • Might fail to trip in several dynamic loads
Adaptive	Any relay	Relay setting changes according to network state	<ul style="list-style-type: none"> • Compatibility relay setting with power system conditions • Online system 	<ul style="list-style-type: none"> • Requiring network upgrades • Requiring a prior knowledge of configurations • Communication requirements • Fault calculations for relay settings

4. Future Trends of Protection Systems

The structure of the futuristic power systems may be changed with the high penetration of renewable energies. Predicting the future of power systems, it is expected to increase in the number interconnected power systems including wind and solar sources [125]. The power system's reliability and protection will become more important with the increasing demand for electrical energy. For this reason, a comprehensive protection system is required with a central controller, and the data processing of the central control system is performed using intelligent systems.

4.1. Wide Area Protection (WAP)

Wide area protection (WAP) is a protection and control system that can meet the future challenges of protection. This system is a new concept that has been proposed with the complexity of the power system and the high penetration of distributed generations in recent years [126–128]. The WAP system improves reliability and stability performance and coordinates protective relays. Moreover, the performance of WAP is based on power system data through network communication. It can detect and clear the fault selectively and quickly. Then, it analyzes the effect of power system stability after fault components disconnection and uses appropriate control measures [126]. The performance time of a WAP system has significant importance during the fault. The WAP should collect data from different locations of the protected areas and analyze data collecting to respond to the disturbances in a somewhat longer time frame. The processing time of the WAP system operation is long due to the communication delays during the information transmission process. The speed of the operation leads to the use of wide-area information to enhance the reliability of backup protection. It is imagined that improved communication and measurements will provide enhanced solutions to protect against instability in the future [127].

The research works in References [128–130] have introduced wide-area protection algorithms. Reference [131] proposed a WAP algorithm based on the composite impedance directional principle that can realize fault detection. The authors of Reference [132] presented a wide-area backup protection algorithm using distance protection fitting factor because of time delay and potential information loss problem in wide-area data acquisition. Reference [129] mainly focused on three aspects of the WAP-based methods:

- (1) Online adaptive computing and verification of protection settings;
- (2) Preventing chain trips of backup protections by recognizing large-scale flow transfer and faults with the help of a regional stability control system;
- (3) Wide-area backup protection centering on the identification of fault equipment, which also takes advantage of PMU/WAMS.

RTUs are data acquisition and digital measurements. SCADA systems use RTUs to collect data from remote sites and send them to the energy management system (EMS) every two to ten seconds. Computer-based devices can record and store massive amounts of data aperiodicity depending upon the intended purpose of the device [133,134]. The SCADA's sampling speed is very slow and needs to be improved. Furthermore, the technology of conventional SCADAs does not have a phase angle as an analog measurement. Hence, the synchronized phasor measurement technology is required [130,135]. The phasor measurement unit (PMU) can measure the voltage phasor of the installed bus and the current phasors of all the lines connected to that bus [136]. The PMU technologies have a high-speed power system device that can provide synchronized measurements of real-time phasors of voltages and currents, respectively. These technologies are also used for the calculation of voltage and current magnitudes, phase angles, real/reactive power flows, etc. The synchronization is usually achieved by simultaneous sampling of voltage and current waveforms using timing signals from GPS satellites [137–139]. Generally, PMU takes 30 measurements per second, thereby presenting the possibility of a much timelier view of the power system dynamics comparing to conventional

measurements. Basically, PMUs measurements are based on synchronizing, as they are time stamped by the GPS's universal clock [140].

Some of the advantages of using PMUs are summarized as follows [137]:

1. Improving real-time monitoring and control of power system;
2. Enhancing congestion management;
3. State estimation of the power system;
4. Post disturbance analysis of the power system;
5. Overload monitoring and dynamic rating;
6. Restoration of the power system;
7. Protection and control application of distributed generation.

Synchronized data estimated by PMUs will develop the modern wide area protection schemes. Many advanced techniques are developed in communication to improve the protection and accelerate the restoration process, analysis, operation, and planning [141].

4.2. Artificial Intelligence Algorithms

Artificial intelligence (AI) and related technologies are effective in solving complex system controls and decision problems [142]. These techniques, such as expert systems (ESs), GAs, fuzzy logic (FL), and ANNs, have emerged with the development of computers [143,144]. These techniques have brought an advancing frontier in power engineering and power electronics. An intelligent or smart power system with future advanced electrical devices can integrate state-of-the-art power electronics, communication, computers, information, and cyber technologies.

Over the past two decades, the application of AI techniques for protection systems has been studied [145]. As a branch of AI techniques, agents have been introduced into the protection system. The relay agents are classified into the concept of a cooperative protection system by their roles [97,146]. The authors of Reference [147] have proposed an intelligent coordinated protection and control scheme for a distribution network with the integration of wind generation. In References [148–151], several algorithms with AI technologies, such as genetic evolution, Tabu search, and fuzzy control principle were investigated to realize the fault-tolerance function of WAP systems.

Several fault detection methods have been presented according to AI techniques such as the methods based on the expert system [149]. In Reference [152], a distribution harmonic state estimator was developed using a modified particle swarm optimization (PSO) algorithm. This method uses PMU data, line/DG parameters, pseudo measurements, and known uncertainties to estimate the harmonic phasors through the minimization of the error between PMU measurements and the estimated values. Reference [153] proposed an integrated impedance angle (IIA)-based protection scheme using wide-area positive sequence components of voltages and currents with PMUs. The IIA for the lines considers information from both ends of PMU, which is an important key to detect faults in the microgrid.

A weighted least-squares algorithm is applied along with singular value decomposition to estimate the harmonics [154,155]. In References [156], a new hybrid GA method was suggested that was successfully applied to solve DOC relays coordination problems. A DOC relay is usually adjustable with a fixed power system topology in an interconnected power system. The system may change the topologies due to the outages of the transmission lines, transformers, and generating units. Reference [157] investigated the problem of determining the optimum values of time multiplier setting (TMS) and plug setting of DOC relays in different topologies. The study introduces the method to improve the convergence of the GA, as a new hybrid method. In Reference [158], a hybrid method has been proposed to overcome the drawbacks of GA and nonlinear programming (NLP) method, and to determine the optimum settings of OC relays, TMS and plug setting (PS). In References [122,123], a new method has proposed for optimal coordination of DOC relays in microgrids. The optimization method is based on multiple parameters, such as the upper limit of the plug setting multiplier (PSM) in the GA.

In general, the future of protection systems tends towards smart or intelligent grids. A smart grid is a cyber-enabled electric power system that combines information and communication technologies with power engineering. Some of the benefits of smart grids are as follows [159]:

- (1) Providing two-way power and information flows;
- (2) Developing a wide-area monitoring system and pervasive control capability over widespread utilities' assets;
- (3) Enabling energy efficiency and demand-side management;
- (4) Integrating intermittent renewable energy sources into the existing power grid;
- (5) Providing self-healing and resiliency against cyber and physical attacks or system anomalies.

The main differences between smart and traditional power grids are the improvement in controlling, monitoring, and communication systems. Furthermore, a smart grid can effectively improve energy efficiency by using digital technology. The restoration in traditional power grids due to the lack of controller is manual, while smart grids are based on self-healing that enables automatic detection and recovery of the system during a fault. Table 4 illustrates a general comparison between the traditional power grids and smart grids [160,161].

Table 4. Comparison of traditional power grids and smart grids.

Characteristics	Traditional Power Grid	Smart Grid
Topology	Mainly radial	Network
Generation	Centralized (due to the governmental view)	distributed (due to the private view)
Efficiency	Low efficiency	Relatively high efficiency
Control	Limited	More extensive
Reliability	Based on static, offline models	Real-time predictions
Distribution	One-way distribution	Two-way distribution From alternative energy
Monitoring	Manual (due to the lack of sensors)	Self-monitoring using digital technology
Response to Disturbances	Response after faults to prevent further damage	Responds to faults by focusing on prediction
Technology	Electromechanical infrastructure	Digital infrastructure and communication
Restoration	Manual (due to the lack of controller)	Self-healing
Assets Management	Low data relationship with asset management	Planning for an asset with extensive monitoring of their information
Equipment	Failure and blackout	Adaptive and islanding
Customer Choices	Fewer choices	Many choices
Active Participation Consumer	Consumers do not participate	Consumers participate actively
Provision of Power Quality	Slow response to power quality	Rapid resolution of power quality
Resiliency against Cyber-Attack and Natural Disasters	Vulnerability to natural and human destructive actions	High resilience to cyber-attack and natural disasters
New Products, Services, and Markets	Limited opportunity and the market for consumers	Integrated market and the right to choose for customers
Reaction Time	Slow reaction time	Extremely quick reaction time
System Communications	Limited to power companies	Expanded and real-time
Sensors	Few sensors	Multiple sensors throughout

5. Conclusions

This paper presented an overview of protection in power systems and microgrids. Protection systems need to be reviewed to consider the integration of distributed generation technologies. The presence of a microgrid causes many challenges in the protection of the power system. This study addressed these challenges and their solutions. Changing the protective relay settings and the optimal replacement of reclosers have been proposed to improve the performance of OC relays in blinding zones. The DOC relays have been used to avoid false tripping in the presence of DGs. Distributed energy resources should be isolated from the grid with fault. Furthermore, during the

islanding operation of a microgrid, the protection and control are complicated. The presence of the microgrid also affects the recloser/fuse and the short circuit level. In addition, many protection schemes have been proposed to protect the power system against changing the topology in the presence of a microgrid. Various types of protection schemes have been considered to detect faults in microgrids, especially in an inverter-based microgrid in islanded mode. Most studies on microgrid protection in islanded mode were communication-based. Wide-area protection based on measurements obtained from PMU and intelligent protection systems can resolve many issues related to the protection and control of the smart grids in the future. In future protection systems, the wide-area protection can protect the power system with microgrids in proper time, including the time of collecting data, processing, analyzing, and tripping commands during the fault.

Future works for completing this review may discuss various parts of adaptive protection schemes, such as digital relays, communication capabilities, and supervisory software. Moreover, discussing PMUs and communication platforms as well as implementing them in the control and protection of microgrids, especially in islanded mode, might be a hot topic. The structure of future protection systems will consist of adaptive protection and intelligent protection, which will work based on communication with modern digital protective relays using PMU and IDM. The main concern in this regard is the time delay of communication links that plays an important role in future protection designs, especially in microgrids. Moreover, the expansion of adaptive systems with a communication platform increases the risk of cyber-attacks. A protection system must be sufficiently secure against cyber-attacks to prevent blackouts. Therefore, further research specifically on cyber-security is necessary. Fault detection in an inverter-based microgrid in islanded mode with/without a communication scheme is an interesting subject for future studies.

Author Contributions: Conceptualization, J.S.F. and E.M.G.R.; Data curation, M.Z.; formal analysis, A.N.; funding acquisition, R.M.; methodology, J.S.F. and E.M.G.R.; supervision, R.M. and E.M.G.R.; writing—original draft, J.S.F. and M.Z.; writing—review and editing, A.N., E.M.G.R. and A.N. All authors have read and agreed to the published version of the manuscript.

Funding: This work was funded by Foundation for Science and Technology (FCT) under the ICT (Institute of Earth Sciences) project UIDB/04683/2020; Portuguese Funds through the Foundation for Science and Technology (FCT) under the LAETA project UIDB/50022/2020.

Conflicts of Interest: The authors declare no conflict of interest

References

1. Haes Alhelou, H.; Hamedani-Golshan, M.E.; Cuthbert Njenda, T.; Siano, P. A survey on power system blackout and cascading events: Research motivations and challenges. *Energies* **2019**, *12*, 682. [\[CrossRef\]](#)
2. Chen, J.; Thorp, J.S.; Dobson, I. Cascading dynamics and mitigation assessment in power system disturbances via a hidden failure model. *Int. J. Electric. Power Energy Syst.* **2005**, *27*, 318–326. [\[CrossRef\]](#)
3. Pourbeik, P.; Kundur, P.S.; Taylor, C.W. The anatomy of a power grid blackout-Root causes and dynamics of recent major blackouts. *IEEE Power Energy Mag.* **2006**, *4*, 22–29. [\[CrossRef\]](#)
4. Allen, E.; Andresson, G.; Berizzi, A.; Boroczky, S.; Canizares, C.; Chen, Q.; Corsi, S.; Dagle, J.E.; Danell, A.; Dobson, I.; et al. *Blackout Experiences and Lessons, Best Practices for System Dynamic Performance, and The Role of New Technologies*; IEEE: Piscataway, NJ, USA, 2007.
5. Ward, S.; Gwyn, B.; Antonova, G.; Apostolov, A.; Austin, T.; Beaumont, P.; Beresh, B.; Bradt, D.; Brunello, G.; Bui, D.-P.; et al. Redundancy considerations for protective relaying systems. In Proceedings of the 63rd Annual Conference for Protective Relay Engineers, College Station, TX, USA, 29 March–1 April 2010.
6. Walke, S.B.; Jangle, N.N. Methods for relay coordination. In Proceedings of the International Conference on Computing Methodologies and Communication (ICCMC), Erode, India, 18–19 July 2017.
7. Dudor, J.; Padden, L. Problems and solutions for protective relay applications in petroleum facilities-some protection applications for generators and transformers. In Proceedings of the Industry Applications Society 42nd Annual Petroleum and Chemical Industry Conference, Denver, CO, USA, 11–13 September 1995.

8. Mozina, C.J. Implementing NERC guidelines for coordinating generator and transmission protection. In Proceedings of the 65th Annual Conference for Protective Relay Engineers, College Station, TX, USA, 2–5 April 2012.
9. Patel, B.; Bera, P. Detection of power swing and fault during power swing using Lissajous figure. *IEEE Trans. Power Del.* **2018**, *33*, 3019–3027. [[CrossRef](#)]
10. Gilany, M.; Malik, O.; Hope, G. A digital protection technique for parallel transmission lines using a single relay at each end. *IEEE Trans. Power Del.* **1992**, *7*, 118–125. [[CrossRef](#)]
11. Sharafi, A.; Sanaye-Pasand, M.; Jafarian, P. Ultra-high-speed protection of parallel transmission lines using current travelling waves. *IET Gen. Trans. Dist.* **2011**, *5*, 656–666. [[CrossRef](#)]
12. Osman, A.; Malik, O. Protection of parallel transmission lines using wavelet transform. *IEEE Trans. Power Del.* **2004**, *19*, 49–55. [[CrossRef](#)]
13. Bollen, M. Travelling-wave-based protection of double-circuit lines. *IEE Proc. C Gener. Transm. Distrib.* **1993**, *140*, 37–47. [[CrossRef](#)]
14. Jongepier, A.; Van der Sluis, L. Adaptive distance protection of a double-circuit line. *IEEE Trans. Power Del.* **1994**, *9*, 1289–1297. [[CrossRef](#)]
15. Khederzadeh, M. The impact of FACTS device on digital multifunctional protective relays. In Proceedings of the IEEE/PES Transmission Distribution Conference Exhibition, Yokohama, Japan, 6–10 October 2002. [[CrossRef](#)]
16. Taral Falgunibahen, R.; Rashesh, P.M. Impact of Facts Device on Protective Distance Relay. *Int. J. Sci. Eng. Technol.* **2017**, *6*, 159–162.
17. Einvall, C.-H.; Linders, J. A three-phase differential relay for transformer protection. *IEEE Trans. Power Appar. Syst.* **1975**, *94*, 1971–1980. [[CrossRef](#)]
18. Saad, S.M.; Elhaffar, A.; El-Arroudi, K. Optimizing differential protection settings for power transformers. In Proceedings of the Modern Electric Power Systems (MEPS), Wroclaw, Poland, 6–9 July 2015.
19. Cordray, R. Percentage-differential transformer protection. *Elect. Eng.* **1931**, *50*, 361–363. [[CrossRef](#)]
20. Kennedy, L.; Hayward, C. Harmonic-current-restrained relays for differential protection. *Elect. Eng.* **1938**, *57*, 262–271. [[CrossRef](#)]
21. Guzman, A.; Zocholl, Z.; Benmouyal, G.; Altuve, J.H. A current-based solution for transformer differential protection. I. Problem statement. *IEEE Trans. Power Del.* **2001**, *16*, 485–491. [[CrossRef](#)]
22. Zanjani, M.G.M.; Kargar, H.K.; Zanjani, M.G.M. High impedance fault detection of distribution network by phasor measurement units. Proceedings of 17th Conference on Electrical Power Distribution, Tehran, Iran, 2–3 May 2012.
23. Chakraborty, S.; Das, S. Application of smart meters in high impedance fault detection on distribution systems. *IEEE Trans. Smart Grid* **2018**, *10*, 3465–3473. [[CrossRef](#)]
24. Mortazavi, S.H.; Moravej, Z.; Shahrtash, S.M. A searching based method for locating high impedance arcing fault in distribution networks. *IEEE Trans. Power Deliv.* **2018**, *34*, 438–447. [[CrossRef](#)]
25. Cui, Q.; El-Arroudi, K.; Weng, Y. A feature selection method for high impedance fault detection. *IEEE Trans. Power Deliv.* **2019**, *34*, 1203–1215. [[CrossRef](#)]
26. Lai, T.M.; Snider, L.A.; Lo, E.; Sutanto, D. High-impedance fault detection using discrete wavelet transform and frequency range and RMS conversion. *IEEE Trans. Power Deliv.* **2005**, *20*, 397–407. [[CrossRef](#)]
27. Sinclair, A.; Finney, D.; Martin, D.; Sharma, P. Distance protection in distribution systems: How it assists with integrating distributed resources. In Proceedings of the IEEE Transactions on Industry Applications, Stone Mountain, GA, USA, 19 March 2013; Volume 50, pp. 2186–2196.
28. Ton, D.T.; Smith, M.A. The US department of energy’s microgrid initiative. *Electric. J.* **2012**, *25*, 84–94. [[CrossRef](#)]
29. Brahma, S.M.; Girgis, A.A. Development of adaptive protection scheme for distribution systems with high penetration of distributed generation. *IEEE Trans. Power Del.* **2004**, *19*, 56–63. [[CrossRef](#)]
30. Sahebkar Farkhani, J.; Najafi, A.; Zareein, M.; Godina, R.; Rodrigues, E. Impact of recloser on protecting blind areas of distribution network in the presence of distributed generation. *Appl. Sci.* **2019**, *9*, 5092. [[CrossRef](#)]
31. Javadian, S.A.M.; Haghifam, M.-R.; Bathaee, S.M.T.; Firoozabad, M.F. Analysis of protection system’s risk in distribution networks with DG. *Int. J. Electric. Power Energy Syst.* **2013**, *44*, 688–695. [[CrossRef](#)]
32. Zayandehroodi, H.; Mohamed, A.; Shareef, H. Comprehensive review of protection coordination methods in power distribution systems in the presence of DG. *Przeglad Elektrotechniczny* **2011**, *87*, 142–148.

33. Hossain, E.; Kabalci, E.; Bayindir, R.; Perez, R. Microgrid testbeds around the world: State of art. *Energy Convers. Manag.* **2014**, *86*, 132–153. [[CrossRef](#)]
34. Zeineldin, H.; El-Saadany, E.; Salama, M. Distributed generation micro-grid operation: Control and protection. In Proceedings of the Power Systems Conference: Advanced Metering, Protection, Control, Communication, and Distributed Resources, Clemson, SC, USA, 14–17 March 2006.
35. Yoldaş, Y.; Onen, A.; Vasilakos, A.; Muyeen, S.M. Enhancing smart grid with microgrids: Challenges and opportunities. *Ren. Sustain. Energy Rev.* **2017**, *72*, 205–214. [[CrossRef](#)]
36. Monadi, M.; Zamani, M.A.; Candela, J.I.; Luna, A. Protection of AC and DC distribution systems embedding distributed energy resources: A comparative review and analysis. *Ren. Sustain. Energy Rev.* **2015**, *51*, 1578–1593. [[CrossRef](#)]
37. Yao, T.; Li, Z.; Qu, J.; Li, Z.; Zhao, Q.; Zhao, G. Research on simplified model of AC/DC hybrid microgrid for fault analysis. *Electronics* **2020**, *9*, 358. [[CrossRef](#)]
38. Abdulwahid, A.H. A new concept of an intelligent protection system based on a discrete wavelet transform and neural network method for smart grids. In Proceedings of the 2nd International Conference of the IEEE Nigeria Computer Chapter (NigeriaComputConf), Zaria, Nigeria, 14–17 October 2019.
39. Brearley, B.J.; Prabu, R.R. A review on issues and approaches for microgrid protection. *Ren. Sustain. Energy Rev.* **2017**, *67*, 988–997. [[CrossRef](#)]
40. Senarathna, T.; Hemapala, K.U. Review of adaptive protection methods for microgrids. *AIMS Energy* **2019**, *7*, 557–578. [[CrossRef](#)]
41. Haron, A.R.; Mohamed, A.; Shareef, H. A review on protection schemes and coordination techniques in microgrid system. *J. Anim. Polut. Sci.* **2012**, *12*, 101–112. [[CrossRef](#)]
42. Casagrande, E.; Woon, W.; Zeineldin, H.; Svetinovic, D. A differential sequence component protection scheme for microgrids with inverter-based distributed generators. *IEEE Trans. Smart Grid* **2013**, *5*, 29–37. [[CrossRef](#)]
43. Papaspiliotopoulos, V.; Korres, G.; Kleftakis, V.; Natziargyriou, N. Hardware-in-the-loop design and optimal setting of adaptive protection schemes for distribution systems with distributed generation. *IEEE Trans. Power Deliv.* **2015**, *32*, 393–400. [[CrossRef](#)]
44. Sortomme, E.; Venkata, S.; Mitra, J. Microgrid protection using communication-assisted digital relays. *IEEE Trans. Power Deliv.* **2009**, *25*, 2789–2796. [[CrossRef](#)]
45. Anil Kumar, P.; Shankar, J.; Nagaraju, Y. Protection issues in micro grid. *Int. J. Appl. Control Electr. Electron. Eng.* **2013**, *1*, 19–30.
46. Telukunta, V.; Pradhana, J.; Agrawal, A.; Singh, M. Protection challenges under bulk penetration of renewable energy resources in power systems: A review. *CSEE J. Power Energy Syst.* **2017**, *3*, 365–379. [[CrossRef](#)]
47. Farkhani, J.S.; Zareein, M.; Soroushmehr, H.; Siece, M. Coordination of directional overcurrent protection relay for distribution network with embedded DG. In Proceedings of the 5th Conference on Knowledge Based Engineering and Innovation (KBEI), Tehran, Iran, 28–29 February 2019.
48. Maleki, M.G.; Chabanloo, R.M.; Javadi, H. Method to resolve false trip of non-directional overcurrent relays in radial networks equipped with distributed generators. *IET Gener. Transm. Distrib.* **2018**, *13*, 485–494. [[CrossRef](#)]
49. Alam, M.N.; Gokaraju, R.; Chakrabarti, S. Protection coordination for networked microgrids using single and dual setting overcurrent relays. *IET Gener. Transm. Distrib.* **2020**, *14*, 2818–2828. [[CrossRef](#)]
50. Thararak, P.; Jirapong, P. Implementation of optimal protection coordination for microgrids with distributed generations using quaternary protection scheme. *J. Electr. Comput. Eng.* **2020**, *2020*. [[CrossRef](#)]
51. Wang, B.; Jing, L. A protection method for inverter-based microgrid using current-only polarity comparison. *J. Modern Power Syst. Clean Energy* **2019**, *8*, 446–453. [[CrossRef](#)]
52. Obaidat, M.S.; Anpalagan, A.; Woungang, I. *Handbook of Green Information and Communication Systems*; Academic Press: Cambridge, MA, USA, 2012.
53. Ramamoorthy, M.; Lalitha, S.V.N.L. *Microgrid Protection Systems, in Micro-Grids-Applications, Solutions, Case Studies, and Demonstrations*; IntechOpen: London, UK, 2019.
54. Li, F.; Li, R.; Zhou, F. *Microgrid Technology and Engineering Application*; Elsevier: Amsterdam, The Netherlands, 2015.
55. Zamani, M.A.; Yazdani, A.; Sidhu, T.S. A communication-assisted protection strategy for inverter-based medium-voltage microgrids. *IEEE Trans. Smart Grid* **2012**, *3*, 2088–2099. [[CrossRef](#)]

56. Supannon, A.; Jirapong, P. Recloser-fuse coordination tool for distributed generation installed capacity enhancement. In Proceedings of the IEEE Innovative Smart Grid Technologies-Asia (ISGT ASIA), Bangkok, Thailand, 3–6 November 2015.
57. Shah, P.H.; Bhalja, B.R. New adaptive digital relaying scheme to tackle recloser–fuse miscoordination during distributed generation interconnections. *IET Gener. Transm. Distrib.* **2014**, *8*, 682–688. [[CrossRef](#)]
58. Wheeler, K.A.; Faried, S.O.; Elsamahy, M. Assessment of distributed generation influences on fuse-recloser protection systems in radial distribution networks. In Proceedings of the IEEE/PES Transmission and Distribution Conference and Exposition (T&D), Dallas, TX, USA, 3–5 May 2016.
59. Sahoo, S.S. *Protection in Inverter Based Microgrids*; Department of Energy Science and Engineering Indian Institute of Technology: Bombay, India, 2019.
60. Photovoltaics, D.G.; Storage, E. IEEE application guide for IEEE Std 1547™, IEEE standard for interconnecting distributed resources with electric power systems. *IEEE Std.* **2009**. [[CrossRef](#)]
61. Turcotte, D.; Katiraei, F. Fault contribution of grid-connected inverters. In Proceedings of the IEEE Electrical Power & Energy Conference (EPEC), Montreal, QC, Canada, 22–23 October 2009.
62. El-Khattam, W.; Sidhu, T.S. Restoration of directional overcurrent relay coordination in distributed generation systems utilizing fault current limiter. *IEEE Trans. Power Deliv.* **2008**, *23*, 576–585. [[CrossRef](#)]
63. Razavi, S.-E.; Ehsan, R.; Sadegh, J.M.; Ali Esmaeel, N.; Mohamed, L.; Miadreza, S.-K.; Catalao, J.P.S. Impact of distributed generation on protection and voltage regulation of distribution systems: A review. *Ren. Sustain. Energy Rev.* **2019**, *105*, 157–167. [[CrossRef](#)]
64. Prasai, A.; Du, Y.; Paquette, A.; Buck, E.; Harley, R.; Divan, D. Protection of meshed microgrids with communication overlay. In Proceedings of the IEEE Energy Conversion Congress and Exposition, Atlanta, GA, USA, 12–16 September 2010.
65. Chattopadhyay, B.; Sachdev, M.; Sidhu, T. An on-line relay coordination algorithm for adaptive protection using linear programming technique. *IEEE Trans. Power Deliv.* **1996**, *11*, 165–173. [[CrossRef](#)]
66. Wan, H.; Li, K.; Wong, K. An adaptive multiagent approach to protection relay coordination with distributed generators in industrial power distribution system. *IEEE Trans. Ind. Appl.* **2010**, *46*, 2118–2124. [[CrossRef](#)]
67. Chandraratne, C.; Logenthiran, T.; Naayagi, R.T.; Woo, W.L. Overview of adaptive protection system for modern power systems. In Proceedings of the IEEE Innovative Smart Grid Technologies-Asia (ISGT Asia), Singapore, Australia, 22–25 May 2018.
68. Shin, H.; Chae, S.H.; Kim, E.-H. Design of microgrid protection schemes using PSCAD/EMTDC and ETAP programs. *Energies* **2020**, *13*, 5784. [[CrossRef](#)]
69. Ji, L.; Cao, Z.; Hong, Q.; Chang, X.; Fu, Y.; Shi, J.; Mi, Y.; Li, Z. An improved inverse-time over-current protection method for a microgrid with optimized acceleration and coordination. *Energies* **2020**, *13*, 5726. [[CrossRef](#)]
70. Wu, X.; Mutale, J.; Jenkins, N.; Strbac, G. *An Investigation of Network Splitting for Fault Level Reduction*; The Manchester Centre for Electrical Energy (MCEE) UMIST: Manchester, UK, 2003.
71. Kovalsky, L.; Yuan, X.; Tekletsadik, K.; Keri, A.; Bock, J.; Breuer, F. Applications of superconducting fault current limiters in electric power transmission systems. *IEEE Trans. Appl. Superconduct.* **2005**, *15*, 2130–2133. [[CrossRef](#)]
72. Safaei, A.; Zolfaghari, M.; Gilvanejad, M.; Gharehpetian, G.B. A survey on fault current limiters: Development and technical aspects. *Int. J. Electric. Power Energy Syst.* **2020**, *118*, 105729. [[CrossRef](#)]
73. Heidary, A.; Radmanesh, H.; Rouzbehi, K.; Mehrizi-Sani, A.; Gharehpetian, G.B. Inductive fault current limiters: A review. *Electric Power Syst. Res.* **2020**, *187*, 106499. [[CrossRef](#)]
74. Lin, H.; Liu, C.; Guerro, J.M.; Vasquez Quintero, J.C. Distance protection for microgrids in distribution system. In Proceedings of the IECON 2015-41st Annual Conference of the IEEE Industrial Electronics Society, Yokohama, Japan, 9–12 November 2015.
75. Thomas, D.W.; Carvalho, R.J.; Pereira, E.T. Fault location in distribution systems based on traveling waves. In Proceedings of the IEEE Bologna Power Tech Conference Proceedings, Bologna, Italy, 23–26 June 2003.
76. Lorenc, J.; Kwapisz, A.; Musierowicz, K. Efficiency of admittance relays during faults with high fault resistance values in MV networks. In Proceedings of the IEEE Russia Power Tech, Moscow, Russia, 27–30 June 2005.
77. Dewadasa, J.M.; Ghosh, A.; Ledwich, G. Distance protection solution for a converter controlled microgrid. In Proceedings of the 15th National Power Systems Conference, Bombay, Mumbai, 16–18 December 2008.

78. Gilany, M.; Al-Kandari, A.; Madouh, J. A new strategy for determining fault zones in distance relays. *IEEE Trans. Power Deliv.* **2008**, *23*, 1857–1863. [[CrossRef](#)]
79. Al_Kababjie, M.F.; Al_Durzi, F.; Al_Nuaimi, N.H. A fault detection and classification using new distance relay. In Proceedings of the First International Conference on Renewable Energies and Vehicular Technology, Hammamet, Tunisia, 26–28 March 2012.
80. Jiang, J.-A.; Fan, P.; Chen, S.C.; Yu, C.; Cheu, J.-Y. A fault detection and faulted-phase selection approach for transmission lines with Haar wavelet transform. In Proceedings of the IEEE PES Transmission and Distribution Conference and Exposition, Dallas, TX, USA, 7–12 September 2003.
81. Shaik, A.G.; Pulipaka, R.R.V. A new wavelet based fault detection, classification and location in transmission lines. *Int. J. Electric. Power Energy Syst.* **2015**, *64*, 35–40. [[CrossRef](#)]
82. Baloch, S.; Jamali, S.Z.; Khawaja, K.; Ali Bukhari, S.B. Microgrid protection strategy based on the autocorrelation of current envelopes using the squaring and Low-pass filtering method. *Energies* **2020**, *13*, 2350. [[CrossRef](#)]
83. Lee, K.-M.; Park, C.-W. Ground fault detection using hybrid method in IT system LVDC microgrid. *Energies* **2020**, *13*, 2606. [[CrossRef](#)]
84. Magnago, F.H.; Abur, A. Fault location using wavelets. *IEEE Trans. Power Deliv.* **1998**, *13*, 1475–1480. [[CrossRef](#)]
85. Crossley, P.; McLaren, P. Distance protection based on travelling waves. *IEEE Trans. Power Appar. Syst.* **1983**, *9*, 2971–2983. [[CrossRef](#)]
86. Li, X.; Dyśko, A.; Burt, G.M. Traveling wave-based protection scheme for inverter-dominated microgrid using mathematical morphology. *IEEE Trans. Smart Grid* **2014**, *5*, 2211–2218. [[CrossRef](#)]
87. Ghaedi, A.; Golshan, M.E.H.; Sanaye-Pasand, M. Transmission line fault location based on three-phase state estimation framework considering measurement chain error model. *Electric Power Syst. Res.* **2020**, *178*, 106048. [[CrossRef](#)]
88. Dashti, R.; Ghasemi, M.; Daisy, M. Fault location in power distribution network with presence of distributed generation resources using impedance based method and applying π line model. *Energy* **2018**, *159*, 344–360. [[CrossRef](#)]
89. Elkhatib, M.E.; Ellis, A. Communication-assisted impedance-based microgrid protection scheme. In Proceedings of the IEEE Power & Energy Society General Meeting, Chicago, IL, USA, 16–20 July 2017.
90. Anderson, P.M. *Power System Protection, ser. Power Engineering*; IEEE Press: Piscataway, NJ, USA, 1999.
91. Zimmerman, K.; Costello, D. Fundamentals and improvements for directional relays. In Proceedings of the 63rd Annual Conference for Protective Relay Engineers, College Station, TX, USA, 29 March–1 April 2010.
92. Nunes, J.; Bretas, A. A impedance-based fault location technique for unbalanced distributed generation systems. In Proceedings of the IEEE Trondheim PowerTech, Trondheim, Norway, 19–23 June 2011.
93. Bayati, N.; Baghaee, H.R.; Hajiyadeh, A.; Soltani, M. Localized protection of radial DC microgrids with high penetration of constant power loads. *IEEE Syst. J.* **2020**. [[CrossRef](#)]
94. PE, A.V.; Lukic, S. Microgrid protection and control Schemes for seamless transition to island and grid synchronization. *IEEE Trans. Smart Grid* **2020**. [[CrossRef](#)]
95. Yabe, K. Power differential method for discrimination between fault and magnetizing inrush current in transformers. *IEEE Trans. Power Deliv.* **1997**, *12*, 1109–1118. [[CrossRef](#)]
96. Breingan, W.; Chen, M.; Gallen, T. The laboratory investigation of a digital system for the protection of transmission lines. *IEEE Trans. Power Appar. Syst.* **1979**, *2*, 350–368. [[CrossRef](#)]
97. Sheng, S.; Li, K.K.; Zeng, X.; Shi, D.; Duan, X. Adaptive agent-based wide-area current differential protection system. *IEEE Trans. Ind. Appl.* **2010**, *46*, 2111–2117. [[CrossRef](#)]
98. Shabani, A.; Mazlumi, K. Evaluation of a communication-assisted overcurrent protection scheme for photovoltaic-based DC microgrid. *IEEE Trans. Smart Grid* **2019**, *11*, 429–439. [[CrossRef](#)]
99. Seo, H.-C. New protection scheme in loop Distribution system with distributed generation. *Energies* **2020**, *13*, 5897. [[CrossRef](#)]
100. Kahrobaeian, A.; Mohamed, Y.A.-R.I. Interactive distributed generation interface for flexible micro-grid operation in smart distribution systems. *IEEE Trans. Sustain. Energy* **2012**, *3*, 295–305. [[CrossRef](#)]
101. Merino, J.; Mendoza-Araya, P.; Venkataramanan, G.; Baysal, M. Islanding detection in microgrids using harmonic signatures. *IEEE Trans. Power Deliv.* **2014**, *30*, 2102–2109. [[CrossRef](#)]

102. Hui, J.; Freitas, W.; Vieira, J.C.M.; Yang, H.; Liu, Y. Utility harmonic impedance measurement based on data selection. *IEEE Trans. Power Deliv.* **2012**, *27*, 2193–2202. [[CrossRef](#)]
103. Shi, H.; Yang, Z.; Yue, X.; Hou, L.; Zhuo, F. Calculation and measurement of harmonic impedance for a microgrid operating in islanding mode. In Proceedings of the 7th International Power Electronics and Motion Control Conference, Harbin, China, 2–5 June 2012.
104. Al-Nasser, H.; Redfern, M. Harmonics content based protection scheme for micro-grids dominated by solid state converters. In Proceedings of the 12th International Middle-East Power System Conference, Aswan, Egypt, 26 February 2008.
105. Beheshtaein, S.; Cuzner, R.; Savaghebi, M.; Guerrero, J.M. A new harmonic-based protection structure for meshed microgrids. In Proceedings of the IEEE Power & Energy Society General Meeting (PESGM), Portland, OR, USA, 5–10 August 2018.
106. Zamani, M.A.; Sidhu, T.S.; Yazdani, A. A protection strategy and microprocessor-based relay for low-voltage microgrids. *IEEE Trans. Power Deliv.* **2011**, *26*, 1873–1883. [[CrossRef](#)]
107. Jiang, W.; He, Z.-Y.; Bo, Z.-Q. The overview of research on microgrid protection development. In Proceedings of the International Conference on Intelligent System Design and Engineering Application, Changsha, China, 13–14 October 2010.
108. Al-Nasser, H.; Redfern, M.; Li, F. A voltage based protection for micro-grids containing power electronic converters. In Proceedings of the IEEE Power Engineering Society General Meeting, Montreal, QC, Canada, 18–22 June 2006.
109. Haddad, K.; Joos, G.; Chen, S. Control algorithms for series static voltage regulators in faulted distribution systems. In Proceedings of the 30th Annual IEEE Power Electronics Specialists Conference. Record (Cat. No. 99CH36321), Charleston, SC, USA, 1 July 1999.
110. Redfern, M.; Al-Nasser, H. Protection of micro-grids dominated by distributed generation using solid state converters. In Proceedings of the IET 9th International Conference on Developments in Power System Protection, Glasgow, UK, 17–18 March 2008.
111. Shen, S.; Lin, D.; Wang, H.; Hu, P.; Jiang, K.; Lin, D.; He, B. An adaptive protection scheme for distribution systems with DGs based on optimized Thevenin equivalent parameters estimation. *IEEE Trans. Power Deliv.* **2015**, *32*, 411–419. [[CrossRef](#)]
112. Shih, M.Y.; Salazar, C.A.C.; Enríquez, A.C. Adaptive directional overcurrent relay coordination using ant colony optimisation. *IET Gener. Transm. Distrib.* **2015**, *9*, 2040–2049. [[CrossRef](#)]
113. Alam, M.N. Adaptive protection coordination scheme using numerical directional overcurrent relays. *IEEE Trans. Ind. Inform.* **2018**, *15*, 64–73. [[CrossRef](#)]
114. Abdelaziz, A.Y.; Talaat, H.E.A.; Nosseir, A.I.; Hajjar, A.A. An adaptive protection scheme for optimal coordination of overcurrent relays. *Electric Power Syst. Res.* **2002**, *61*, 1–9. [[CrossRef](#)]
115. Shandilya, S. *Handbook of Research on Emerging Technologies for Electrical Power Planning. Analysis and Optimization*; IGI Global: Hershey, PA, USA, 2016; pp. 978–981.
116. Gashteroodkhani, O.; Majidi, M.; Etezadi-Amoli, M. A combined deep belief network and time-time transform based intelligent protection Scheme for microgrids. *Electric Power Syst. Res.* **2020**, *182*, 106239. [[CrossRef](#)]
117. Oudalov, A.; Fidigatti, A. Adaptive network protection in microgrids. *Int. J. Distrib. Energy Resour.* **2009**, *5*, 201–226.
118. Che, L.; Khodayar, M.E.; Shahidehpour, M. Adaptive Protection System for Microgrids: Protection practices of a functional microgrid system. *IEEE Electr. Mag.* **2014**, *2*, 66–80. [[CrossRef](#)]
119. Tsimtsios, A.M.; Nikolaidis, V.C. Towards plug-and-play protection for meshed distribution systems with DG. *IEEE Trans. Smart Grid* **2019**. [[CrossRef](#)]
120. Purwar, E.; Vishwakarma, D.; Singh, S. A novel constraints reduction-based optimal relay coordination method considering variable operational status of distribution system with DGs. *IEEE Trans. Smart Grid* **2017**, *10*, 889–898. [[CrossRef](#)]
121. Lin, H.; Guerrero, J.M.; Tan, C.J.Z.H.; Vasquez, J.C.; Liu, C. Adaptive overcurrent protection for microgrids in extensive distribution systems. In Proceedings of the IECON 2016-42nd Annual Conference of the IEEE Industrial Electronics Society, Florence, Italy, 23–26 October 2016.
122. Saldarriaga-Zuluaga, S.D.; López-Lezama, J.M.; Muñoz-Galeano, N. Optimal coordination of overcurrent relays in microgrids considering a non-Standard characteristic. *Energies* **2020**, *13*, 922. [[CrossRef](#)]

123. Saldarriaga-Zuluaga, S.D.; López-Lezama, J.M.; Muñoz-Galeano, N. An approach for optimal coordination of over-current Relays in Microgrids with distributed generation. *Electronics* **2020**, *9*, 1740. [[CrossRef](#)]
124. Beheshtaein, S.; Cuzner, R.; Savaghebi, M.; Guerro, J.M. Review on microgrids protection. *IET Gener. Transm. Distrib.* **2019**, *13*, 743–759. [[CrossRef](#)]
125. Zidan, A.; Gabbar, H. Scheduling interconnected micro energy grids with multiple fuel options. In *Smart Energy Grid Engineering*; Elsevier: London, UK, 2017; pp. 83–99.
126. Qin, H.-X.; Yao, B. Research and engineering practice of wide area protection and control systems. *J. Int. Counc. Electric. Eng.* **2013**, *3*, 169–173. [[CrossRef](#)]
127. Adamiak, M.; Apostolov, A.P.; Begovic, M.M.; Henville, C.F.; Martin, K.E.; Michel, G.L.; Phadke, A.G.; Thorp, J.S. Wide area protection—Technology and infrastructures. *IEEE Trans. Power Deliv.* **2006**, *21*, 601–609. [[CrossRef](#)]
128. Corsi, S. Wide area voltage protection. *IET Gener. Transm. Distrib.* **2010**, *4*, 1164–1179. [[CrossRef](#)]
129. Dai, Z.-H.; Wang, Z.-P.; Jiao, Y.-J. Reliability evaluation of the communication network in wide-area protection. *IEEE Trans. Power Deliv.* **2011**, *26*, 2523–2530. [[CrossRef](#)]
130. Begovic, M.; Novosel, D.; Karlsson, D.; Henville, C.; Michel, G. Wide-area protection and emergency control. *Proc. IEEE* **2005**, *93*, 876–891. [[CrossRef](#)]
131. Li, Z.; Wan, Y.; Wu, L.; Cheng, Y.; Weng, H. Study on wide-area protection algorithm based on composite impedance directional principle. *Int. J. Elect. Power Energy Syst.* **2020**, *115*, 105518. [[CrossRef](#)]
132. Ma, J.; Liu, C.; Thorp, J.S. A wide-area backup protection algorithm based on distance protection fitting factor. *IEEE Trans. Power Deliv.* **2015**, *31*, 2196–2205. [[CrossRef](#)]
133. Kezunovic, M. Smart fault location for smart grids. *IEEE Trans. Smart Grid* **2011**, *2*, 11–22. [[CrossRef](#)]
134. Misbahuddin, S. Fault tolerant remote terminal units (RTUs) in SCADA systems. In Proceedings of the International Symposium on Collaborative Technologies and Systems, Chicago, IL, USA, 17–21 May 2010.
135. Horowitz, S.; Phadke, A. *Power System Relaying*; Research Studies Press Ltd.: Somerst, UK, 1995.
136. Guo, Y.; Yang, Z.; Feng, S.; Hu, J. Complex power system status monitoring and evaluation using big data platform and machine learning algorithms: A review and a case study. *Complexity* **2018**, *2018*. [[CrossRef](#)]
137. Panshanwar, M.K.; Gavande, M.; Satarkar, M.F.A.R. Phasor Measurement unit technology and its applications—A review. In Proceedings of the International Conference on Energy Systems and Applications, Pune, India, 30 October–1 November 2015.
138. Waikar, D.; Elangovan, S.; Liew, A.C.; Sng, S.H. Real-time assessment of a symmetrical component and microcontroller based distance relay. *Electric Power Syst. Res.* **1995**, *32*, 107–112. [[CrossRef](#)]
139. Nuqui, R.F.; Phadke, A.G. Phasor measurement unit placement techniques for complete and incomplete observability. *IEEE Trans. Power Deliv.* **2005**, *20*, 2381–2388. [[CrossRef](#)]
140. Huang, Y.-F.; Werner, S.; Jing, H.; Neelabh, K.; Vijay, G. State estimation in electric power grids: Meeting new challenges presented by the requirements of the future grid. *IEEE Signal Proces. Mag.* **2012**, *29*, 33–43. [[CrossRef](#)]
141. Guardado, R.A.; Guardado, J.L. A PMU model for wide-area protection in ATP/EMTP. *IEEE Trans. Power Deliv.* **2015**, *31*, 1953–1960. [[CrossRef](#)]
142. Jizhi, X.; Xinyan, Z.; Jianwei, L. Application of artificial intelligence in the Field of Power systems. *J. Electric. Electron. Eng.* **2019**, *7*, 23–28. [[CrossRef](#)]
143. Bose, B.K. Artificial intelligence techniques in smart grid and renewable energy systems—Some example applications. *Proc. IEEE* **2017**, *105*, 2262–2273. [[CrossRef](#)]
144. Ibrahim, W.A.; Morcos, M.M. Artificial intelligence and advanced mathematical tools for power quality applications: A survey. *IEEE Trans. Power Deliv.* **2002**, *17*, 668–673. [[CrossRef](#)]
145. Abdelmoumene, A.; Bentarzi, H. A review on protective relays developments and trends. *J. Energy S. Afr.* **2014**, *25*, 91–95. [[CrossRef](#)]
146. Tomita, Y.; Fukui, C.; Kudo, H.; Koda, J.; Yabe, K. A cooperative protection system with an agent model. *IEEE Trans. Power Deliv.* **1998**, *13*, 1060–1066. [[CrossRef](#)]
147. Liu, Z.; Hoidalén, H.K.; Saha, M.M. An intelligent coordinated protection and control strategy for distribution network with wind generation integration. *CSEE J. Power Energy Syst.* **2016**, *2*, 23–30. [[CrossRef](#)]
148. Li, Z.; Yin, X.; Zhang, Z.; He, Z. Wide-area protection fault identification algorithm based on multi-information fusion. *IEEE Trans. Power Deliv.* **2013**, *28*, 1348–1355.

149. Lin, X.; Ke, S.; Li, Z.; Weng, H.; Han, X. A fault diagnosis method of power systems based on improved objective function and genetic algorithm-tabu search. *IEEE Trans. Power Deliv.* **2010**, *25*, 1268–1274. [[CrossRef](#)]
150. Galijasevic, Z.; Abur, A. Fault location using voltage measurements. *IEEE Trans. Power Deliv.* **2002**, *17*, 441–445. [[CrossRef](#)]
151. Sun, J.; Qin, S.-Y.; Song, Y.-H. Fault diagnosis of electric power systems based on fuzzy Petri nets. *IEEE Trans. Power Syst.* **2004**, *19*, 2053–2059. [[CrossRef](#)]
152. Arefi, A.; Haghifam, M.R.; Fathi, S.H. Distribution harmonic state estimation based on a modified PSO considering parameters uncertainty. Proceedings of the IEEE Trondheim PowerTech, Trondheim, Norway, 19–23 June 2011.
153. Sharma, N.K.; Samantaray, S.R. PMU assisted integrated impedance angle-based microgrid protection scheme. *IEEE Trans. Power Deliv.* **2019**, *35*, 183–193. [[CrossRef](#)]
154. Bahabadi, H.B.; Mirzaei, A.; Moallem, M. Optimal placement of phasor measurement units for harmonic state estimation in unbalanced distribution system using genetic algorithms. In Proceedings of the 21st International Conference on Systems Engineering, Las Vegas, NV, USA, 16–18 August 2011.
155. Sánchez-Ayala, G.; Agüerc, J.R.; Elizondo, D.; Lelic, M. Current trends on applications of PMUs in distribution systems. In Proceedings of the 2013 IEEE PES Innovative Smart Grid Technologies Conference (ISGT), Washington, WA, USA, 19–22 February 2013.
156. Noghabi, A.S.; Sadeh, J.; Mashhadi, H.R. Considering different network topologies in optimal overcurrent relay coordination using a hybrid GA. *IEEE Trans. Power Deliv.* **2009**, *24*, 1857–1863. [[CrossRef](#)]
157. Bedekar, P.P.; Bhide, S.R.; Kale, V.S. Determining optimum TMS and PS of overcurrent relays using big-M method. In Proceedings of the Joint International Conference on Power Electronics, Drives and Energy Systems & 2010 Power India, Mumbai, India, 20 December 2010.
158. Bedekar, P.P.; Bhide, S.R. Optimum coordination of directional overcurrent relays using the hybrid GA-NLP approach. *IEEE Trans. Power Deliv.* **2010**, *26*, 109–119. [[CrossRef](#)]
159. Badihi, H.; Jadidi, S.; Zhang, Y.; Su, C.Y.; Xie, W. AI-driven intelligent Fault Detection and Diagnosis in a hybrid AC/DC microgrid. In Proceedings of the 1st International Conference on Industrial Artificial Intelligence (IAI), Shenyang, China, 22–26 July 2019.
160. Dileep, G. A survey on smart grid technologies and applications. *Renew. Energy* **2020**, *146*, 2589–2625. [[CrossRef](#)]
161. Xu, Z. Smart Grid: Trends in Power Market. Available online: <http://www.cse.wustl.edu/~{j}jain/cse574-10/ftp/grid2/index.html> (accessed on 1 April 2010).

Publisher’s Note: MDPI stays neutral with regard to jurisdictional claims in published maps and institutional affiliations.



© 2020 by the authors. Licensee MDPI, Basel, Switzerland. This article is an open access article distributed under the terms and conditions of the Creative Commons Attribution (CC BY) license (<http://creativecommons.org/licenses/by/4.0/>).