



## Article

# Evolution of the Electricity Distribution Networks—Active Management Architecture Schemes and Microgrid Control Functionalities

Katja H. Sirviö <sup>1,\*</sup>, Hannu Laaksonen <sup>1</sup> , Kimmo Kauhaniemi <sup>1</sup>  and Nikos Hatzargyriou <sup>2</sup> 

<sup>1</sup> School of Technology and Innovations, University of Vaasa, 65100 Vaasa, Finland; hannu.laaksonen@uwasa.fi (H.L.); kimmo.kauhaniemi@uwasa.fi (K.K.)

<sup>2</sup> School of Electrical and Computer Engineering, National Technical University of Athens, 157 80 Athens, Greece; nh@power.ece.ntua.gr

\* Correspondence: katja.sirvio@univaasa.fi; Tel.: +358-50-443-5445

**Abstract:** The power system transition to smart grids brings challenges to electricity distribution network development since it involves several stakeholders and actors whose needs must be met to be successful for the electricity network upgrade. The technological challenges arise mainly from the various distributed energy resources (DERs) integration and use and network optimization and security. End-customers play a central role in future network operations. Understanding the network's evolution through possible network operational scenarios could create a dedicated and reliable roadmap for the various stakeholders' use. This paper presents a method to develop the evolving operational scenarios and related management schemes, including microgrid control functionalities, and analyzes the evolution of electricity distribution networks considering medium and low voltage grids. The analysis consists of the dynamic descriptions of network operations and the static illustrations of the relationships among classified actors. The method and analysis use an object-oriented and standardized software modeling language, the unified modeling language (UML). Operational descriptions for the four evolution phases of electricity distribution networks are defined and analyzed by Enterprise Architect, a UML tool. This analysis is followed by the active management architecture schemes with the microgrid control functionalities. The graphical models and analysis generated can be used for scenario building in roadmap development, real-time simulations, and management system development. The developed method, presented with high-level use cases (HL-UCs), can be further used to develop and analyze several parallel running control algorithms for DERs providing ancillary services (ASs) in the evolving electricity distribution networks.

**Keywords:** adaptive control; demand-side management; energy management; load flow control; load management; microgrids; power system control; power system management; power system simulation; reactive power control; smart grids; voltage control



**Citation:** Sirviö, K.H.; Laaksonen, H.; Kauhaniemi, K.; Hatzargyriou, N. Evolution of the Electricity Distribution Networks—Active Management Architecture Schemes and Microgrid Control Functionalities. *Appl. Sci.* **2021**, *11*, 2793. <https://doi.org/10.3390/app11062793>

Academic Editor: Pierluigi Siano

Received: 18 February 2021

Accepted: 18 March 2021

Published: 21 March 2021

**Publisher's Note:** MDPI stays neutral with regard to jurisdictional claims in published maps and institutional affiliations.



**Copyright:** © 2021 by the authors. Licensee MDPI, Basel, Switzerland. This article is an open access article distributed under the terms and conditions of the Creative Commons Attribution (CC BY) license (<https://creativecommons.org/licenses/by/4.0/>).

## 1. Introduction

The European Union (EU) aims to be climate neutral by 2050, and this goal and the long-term strategy is the core part of the action plan called the Green Deal. The Green Deal aims to significantly reduce emissions, invest in cutting-edge research and innovation, and preserve Europe's natural environment. The climate and energy targets are set until 2030, including a reduction in greenhouse gas (GHG) emissions (at least 40% compared to 1990 level), an increase in the share of renewable energy (at least 32%), and improvement of energy efficiency (to be at least 32.5%). Currently, the European Commission (EC) proposes an updated Climate Target Plan 2030, where the GHG emissions reduction target is 55%. It was published together with the amended proposal for a European Climate Law, which would make the 55% target compulsory [1,2].

Future energy infrastructure must be developed to achieve the ambitious climate targets so that different energy vectors are interconnected to improve efficiency and security. The electricity network is the backbone of this flexible energy system. The future power system or smart grids aim to reduce GHG emissions by using all forms of renewable energy resources (RESs), both central and distributed. Smart grids should be operated intelligently, securing safe and reliable electricity distribution, energy savings, efficient use of energy, and based on advanced energy markets. Furthermore, the future electricity distribution networks or intelligent electricity distribution networks are supposed to connect different types of actors, including new actors and new roles of the existing actors, such as new management systems, aggregators, and prosumers. Different kinds of regulators, utility companies, vendors, and customers face questions such as what type of role(s) they have in the future networks and which kinds of systems must fulfill their needs.

Visions of power grids, evolutions, roadmaps, and development paths are presented in several high-level descriptions. For example, the European Technology and Innovation Platform on Smart Networks for the Energy Transition (ETIP-SNET) describes the European target energy system in Vision 2050 [3]. The roadmap toward 2050 defines 12 functionalities to be implemented in 2020–2030 across the energy system's value chain enabling the energy transition [4]. Two trends are set out: micro (focuses on local solutions) and mega (focuses on the system or even intra-system-wide solutions), enabling high penetration of RES, are presented in [5]. Microgrids can fulfill all 12 functionalities, as presented in [4] as an intelligent subsystem in the future flexible electricity distribution system. At present, significant efforts are devoted to low voltage (LV) grids, which in contrast to medium voltage (MV) grids are passive, and distribution management systems (DMS) are rarely implemented. The descriptions of a management system and a control strategy are essential to integrate the LV distribution networks in smart grids.

Moreover, for managing the LV distribution network in real-time, a DMS is required with transparent data architecture [6,7]. It is important that the transparent system has an object-oriented design, which provides a library with standard objects, and can be adapted to the local conditions. Transparent data architecture allows easy adaptation to specific customer installations.

This paper aims to demonstrate the development of the evolving operational scenarios and the related management schemes, including microgrid control functionalities. The objectives are to (i) define the evolution phases of electricity distribution networks, (ii) define the related key actors, (iii) develop operational scenarios, (iv) provide a structural description of the management system, and (v) conduct an analysis.

The basic elements of the purpose of scenario building for the future are (i) recognizing the facts of the present situation, (ii) a vision of a better future, (iii) state of mind, and (iv) action [8]. The prerequisite for the scenario building or anticipating and envisioning tomorrow is understanding the prevailing facts, which are then summarized by imagination [8]. In addition, the weak signals [9–11] are used individually since they are indicators of changing or emerging topics. The weak signals may be related, for example, to technologies, behaviors, markets, and regulations. It supplements the trend analysis. The megatrends, trends, and weak signals create the envisioned future scenarios expressed by the various use cases (UCs).

The organization of the paper follows the method's use process. First, the overview of the analysis method is presented in Section 2. Next, the key factors of the electricity distribution network development for scenario building are described in Section 3. Section 4 introduces the use of the method for a case study for a Finnish example. Section 5 contains operational descriptions of the evolving electricity distribution networks consisting of the energy management HL-UCs and the ancillary services (ASs) UCs in different evolution phases, the power balance management, and the overcurrent (OC) protection UCs in the microgrid phase. In Section 6, using the same case study as an example, the structural description of the future electricity distribution networks is created for the microgrid phase, including energy management, power balance management, and protection UCs. Section 6

also combines the outcome of the various UCs by developing structural illustrations to analyze the management system of the future electricity distribution networks. In Section 7, the results are discussed. It is shown that the method can help to develop, for example, a commonly understood roadmap. Finally, conclusions are drawn in Section 8.

## 2. Analysis Method Overview

This paper uses an object-oriented method for analyzing the operations and the structure of the evolving electricity distribution networks. Behavioral differences and differences in the static relationships in a studied system are illustrated by the object-oriented unified modeling language (UML) tool, Enterprise Architect. The UML is standardized by ISO/IEC 19501, and by using the UML tool, visual models of systems can be developed for system analysis. These are already used in software engineering for general-level UC descriptions. The UCs can be developed on several levels and for several purposes [12]. Based on the UCs and the diagrams derived from them, the system's operation can be illustrated and used for hardware and software development. This methodology is used in this paper for evolution path description and illustrating and analyzing the development of the distribution network management system.

The evolution phases of the future electricity distribution networks defined in [13] are used here. These are: (i) the traditional network, (ii) the self-sufficient in electric energy, (iii) the microgrid, and (iv) the intelligent network of microgrids, and they were made for LV distribution networks, but they are further developed in this paper to cover MV distribution networks. In the following, energy management, power balance management, and protection UCs are represented in evolution phases, as shown in Figure 1. The vertical axis represents evolution phases of the MV and LV distribution networks, in which the energy management development by the conceptual or high-level use cases (HL-UCs) as well as the case study level or primary use cases (PUC), the microgrid phase's power balance management and protection are studied. The horizontal analysis denotes the parallel and simultaneous HL-UCs, which are studied in this paper in the microgrid phase, affecting the system. An HL-UC can be implemented in various ways, so it cannot be mapped to a particular system or architecture, but a PUC applied to a particular system can be assigned to a defined architecture [14]. These HL-UCs aim to illustrate the system's dynamic behavior, which is studied further by defining the classified actors (objects), and their static relationships in the class diagrams. Hence, the class diagrams provide a static illustration of the system. The evolution phases apply to a suburban or rural area covering a whole electricity distribution network from a primary substation to the customer premises.

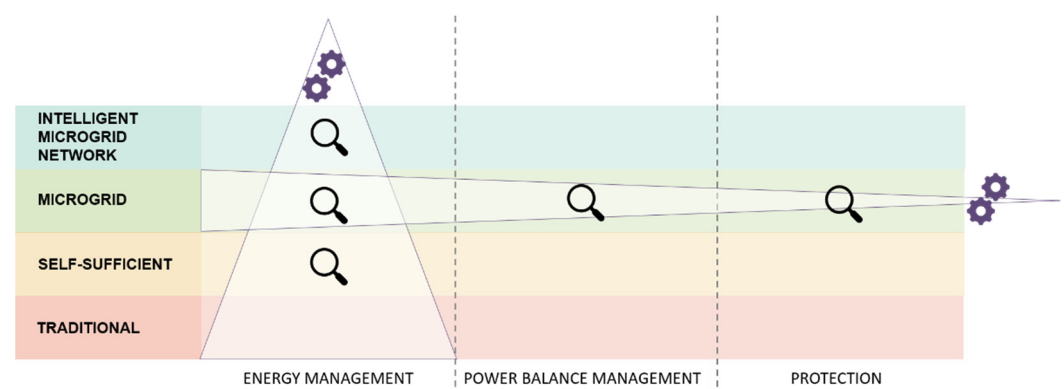
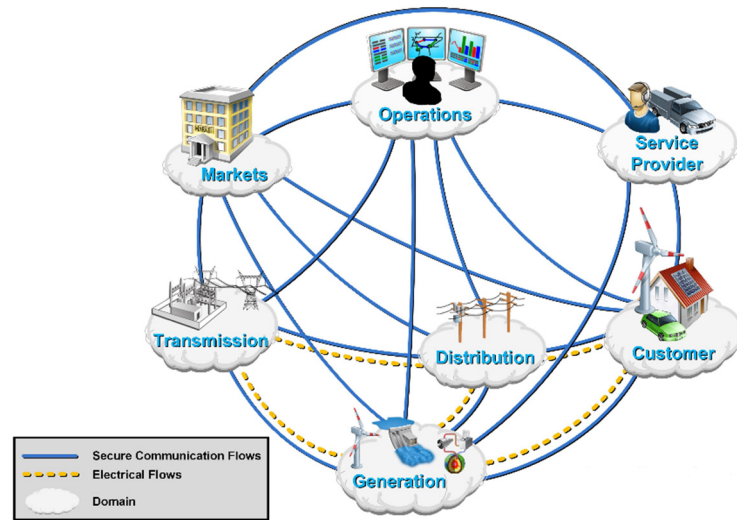

Figure 1. The studied use cases of the developing distribution networks.

The analysis can adopt the smart grid architecture model (SGAM) framework, which includes a methodology for developing UCs, reference architectures, communication technologies, and data-and-information models [15]. The SGAM model can be exploited, for example, for analysis and gap analysis of the developed UCs. Figure 2 illustrates the SGAM model [16], representing the functional information data flows between the main

domains of the smart grids, which is adapted from [17] and later [18], to the European context. The concept integrates several systems and subsystem architectures. Figure 2a presents the smart grid conceptual domains used in this paper for locating the actors. Figure 2b presents the conducted research in the SGAM framework, the developed UC descriptions in the function layer over the distribution, DER (distributed energy resource), and customer premises domains.



(a)

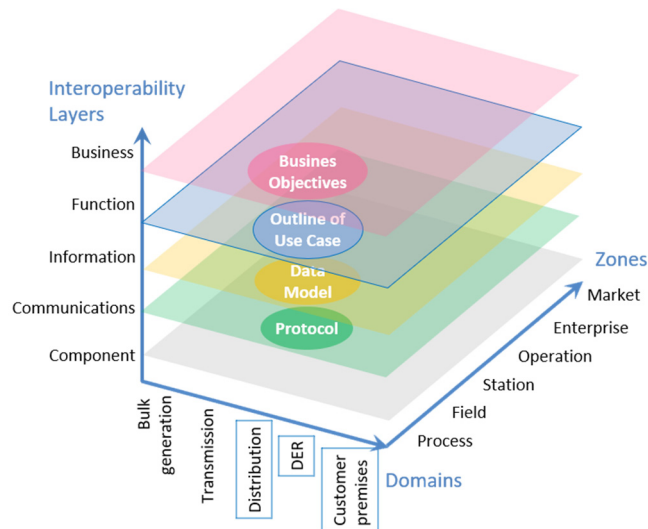

(b)

**Figure 2.** (a) NIST smart grids conceptual model with conceptual domains [18]. (b) Smart grid architecture model, adapted from [16].

### 3. Electricity Distribution Network Development

Along with the social and economic aspects, technology plays a crucial role in developing electricity distribution networks. Technology solutions are the essential enablers giving benefits to the stakeholders, who are the actors operating the system or affected by its operation, having financial or social benefits. Actors can also be systems, devices, software, and events that can perform an operation that changes the state of the system. Implementing new or enhanced concepts in the evolving electricity distribution networks brings new technologies and operation methods but can also cause problems in the traditional electricity distribution operation. For example, the increasing amount of DERs in the power grids causes two-direction power flow between generation and consumption

and intermittent power generation affecting the quality of electricity, safety, and protection issues. Consideration of these challenges is crucial in the electricity distribution network operation and planning.

### 3.1. Active Distribution Networks and Microgrid Concept

According to [19], active distribution networks are defined as: “Active distribution networks (ADNs) have systems in place to control a combination of DERs, defined as generators, loads and storage. With these systems in place, the ADN becomes an Active Distribution System (ADS).” Microgrids are defined in standards, in which IEEE 2030.7 determines: “A group of interconnected loads and distributed energy resources with clearly defined electrical boundaries that act as a single controllable entity concerning to the grid and can connect and disconnect from the grid to enable it to operate in both grid-connected or island modes” [20]. Microgrids are also defined in IEC-TS 62898-1 [21].

This paper assumes that microgrids will be widely used and developed in various installations, as envisioned in the recent power system development roadmap for the EU [4]. Roadmaps of the microgrids evolution are presented in [22–26] in which the microgrid is defined, the microgrid types are introduced, the critical microgrid technologies and functionalities are presented, and the expected benefits are discussed. The roadmaps for commercializing microgrids are presented in [27].

A review of the microgrid development [28] highlights the arguments and drivers, which include policies and research investments, system operators’ activity, various stakeholders, and incentives. One of the key drivers for microgrids’ implementation is the more efficient integration of DERs. Their control and protection need novel technical solutions and applications. Standardization is essential, thus providing compliance of the different (vendors) solutions in control and protection. Key issues are data models and protocols. Based on feasible, proposed, and evaluated business cases, the operational targets can be set.

### 3.2. Distribution Network Planning

ADN and microgrid planning principles and methods are reviewed in [29]. Accordingly, traditional distribution network planning (TDNP) focuses on the optimal sizing and location of distribution substations and feeders and other electrical components. The optimal sizing and location of the DERs can be seen as an extension of TDNP in its transformation to active distribution network planning (ADNP). The challenge with the TDNP is running several planning optimization problems, for example, multiple scenarios simultaneously. In the ADNP, multi-energy and active management strategies are integrated into the TDNP. The ADNP mainly involves the interactive information system, DER participation, and smart automation technology integration, highlighting the planning process. The main objectives are cost, technical features, and performance [29].

The ADN is extended from the TDN with the load forecasting [30], the network planning [31–35], and the power management and control [36,37]. The LV distribution networks are of great interest since they are significantly affected by the connection of DERs; hence, the development of the LV-specific tools is essential to manage and effectively control the LV distribution level. Integrating DERs into the electricity distribution networks raises issues such as uncertainties in various time-series of energy consumption or generation that have to be solved at the ADN planning stage. Spatial forecast, satellite maps, and the geographical information system (GIS) improve planning drastically [38]. Microgrids can be considered as a flexible resource in ADNP [39,40].

From the economic perspective, the methodologies for developing business cases for microgrids are presented, for example, in [41]. For the profitable microgrids creation, a method and a tool for microgrid planning are presented in [42] to decrease the microgrid development cost. In [40], the authors claim that the following high-level steps in the planning, deployment, implementation, and operation of microgrids are needed to succeed: (i) conceptual design, (ii) technical design, (iii) implementation, and (iv) operation and

maintenance. In each step, a variety of tools are used. The authors convince that the optimum would be one ultimate microgrid software combining single tools in one platform.

### 3.3. Network Management, Controls, and Supervisory Systems

Increasing DERs in the power grids, the local energy generation, and the loads can be adjusted to support grid flexibility and congestion management. The two-way power flow and the power electronic interfaces of the DER units create challenges, particularly to the protection systems due to the reduced short circuit currents and the changed direction of fault currents. In addition, information and communication technologies (ICT) are required for managing the DERs and loads locally.

Advanced control technologies for active distribution network management (ADNM) need to be developed to implement various operation modes. The application in which a developed concept is aimed to use gives the ultimate terms and conditions of operation. For example, a microgrid concept application can be a distribution network-interconnected microgrid or an isolated microgrid [43]. Furthermore, the required functionalities can be, for example, power balancing, congestion management, fault management, resiliency, and response to external orders in utility microgrids [43] or a combination of all the above. The management schemes (and architectures) are developed for achieving (and implementing) these desired functionalities. The ADNM schemes can be coordinated voltage control (CVC) and adaptive power factor control (PFC). The protection and automation systems for the network operation management and the implementation of coordinated control and protection schemes make possible ADNM. The ICT and the remote monitoring systems are the enablers for ADN control.

Optimal distribution management planning tools for minimizing the operational costs are to be developed for demand-side management (DSM) [44,45] and Volt/VAr control [46], for example. For the LV distribution networks, the ADNM schemes can be active and reactive power flow optimization, unbalance and reactive power compensation at the point of interconnection (POI), the power balance management in the islanded operation, demand response (DR) at POI, as well as current clearing for the non-load switching operation [47].

The distributed generation (DG) and the consumer DR programs influence the DMS operation by increasing the need to act on real-time operational data, thus increasingly demanding the sensors and information on the power system operation. The DG also affects the traditional DMS applications, such as load modeling and estimation, load flow algorithms, short circuit analysis, relay protection coordination, and fault detection and location, isolation, and service restoration (FLISR) logic. Further, monitoring, control, and data acquisition extend down, even to individual customers, by an advanced metering infrastructure (AMI), DR systems, and home energy management systems (HEMS). The open architecture in the databases (CIM, SOAP, XML, SOA) and the applications permit the improvement in the monitoring and control application of the supervisory control and data acquisition (SCADA) and DMS; integrated Volt/VAr control, databases interfacing via a standard interface with a GIS, an outage management system (OMS), or a meter data management system (MDMS) [48].

### 3.4. Ancillary Services and Reserves

Ancillary services (ASs) support the reliable delivery of electricity and the operation of the transmission systems. The supply and demand must be balanced at every moment, ensuring that frequency, voltage, and power load remain within certain limits. When demand changes, the adjustments and corrections in the power grid are completed with ASs. These services include frequency stability support, power balance, voltage control, supply restoration, and system management, as presented in Table 1 [49].

**Table 1.** Ancillary services.

Ancillary Service Type	Means
Frequency stability support	Frequency control of power, regulation, and operating reserves
Power balance	Scheduling and dispatching of balancing energy
Voltage control	Tap-changer control Reactive power control
Supply restoration	Black start capability Island operation
System management	Power quality assurance operation Asset management

Frequency support services are applied for normal operations: power system balancing and the disturbance situations or unexpected events such as power plant outages or an unforeseen increase in consumption. For example, peak shaving by load shedding is a frequency support method, often provided by heavy industry loads that are deactivated for a short time to guarantee network stability. The spinning reserve compensates for the short-term power failures due to the kinetic energy of power plant generators. RESs do not yet provide spinning reserves, but large wind turbines (WT) might be used [50].

Voltage support services ensure the quality and safety of the supply. With power factor correction, the relation between active and reactive power is adjusted so that voltage is within the operational range and stabilized. The electricity transmission and distribution cause power losses that affect the voltage magnitudes in the grid. The use of the network's capacity (particularly in the cabled network) and capacitors affect energy losses, and consequently, voltage management [50].

After a power failure, supply restoration uses services that power plants can offer with automatic black start capabilities without external energy supply, such as hydroelectric or gas power plants. In addition, electricity storage can be used to ensure the black start capability [50].

ASs can be used for the power grid's operational and bottleneck management. The rise of RES increases demands for the grid operators to manage the network congestion, aiming to avoid the foreseeable potential grid bottlenecks. In congestion management, the power plant operators are instructed to shift the planned electricity generation, called re-dispatch. Another method is the feed-in management for regulating the supply in the case of a power surplus from RES. In addition, the available capacities and capacity mechanisms can be used as ASs. Such services can be for the grid reserves or the reserves to guarantee the reliability of power plants [50].

TSOs are responsible for managing the power balance in the transmission grid in each operating situation. The quality criteria for frequency and voltage must be met in normal operation and abnormal operations. For constant control of frequency in power systems, the frequency containment reserve (FCR) programs are used. Next, the frequency restoration reserve (FFR) programs are implemented for returning the frequency to its normal range and release the FCR back to use. Further, the replacement reserves (RR) can be released to activate the FFR to stand by in case of new disturbances (not used in the Nordic system) [51].

#### 4. Evolution of the Electricity Distribution Networks—A Finnish Case

This paper focuses on the evolution of the electricity distribution networks in the Nordic countries; however, the analysis method and the results can be applied to the distribution networks elsewhere. In the Nordic countries, the electricity distribution system is mainly a three-phase AC system, but some old LV distribution network customers supplied via one-phase. In Finland, the MV distribution network's rated voltage is 21 kV, and the LV distribution is mainly 0.4 kV (in some exceptional cases, 1 kV is used). The earthing method can vary in the Nordic countries. However, in Finland, the MV

distribution networks are typically earth-isolated or compensated systems, and the LV distribution networks are TN systems.

This research describes the UC development of the utility distribution MV and LV networks in a suburban area. The following energy system visions and roadmaps for Finland are used. The Finnish Energy and Climate Roadmap 2050 [52] emphasizes energy system transition to a nearly zero-emission system, energy self-sufficiency, and supply security for reducing emissions. Finland is highly dependent on energy, and the energy consumption per capita is high, and therefore it has traditionally invested in energy efficiency. Though Finland is among the top countries in energy efficiency, energy self-sufficiency is low. The Smart Grid Vision for 2025 [53,54] put the customer in the center for giving him better opportunities to participate in the electricity markets. It is also essential to improve the security of supply and create new business opportunities for the companies. A supplementary vision and roadmap for the Finnish power system, Vision for the Future Electricity Network and Electricity Market 2035 & a Road Map 2025 [55], is used in this research.

Next, an overview of the Finnish power system's electricity marketplaces is given. The evolution phases of the electricity distribution networks are defined, and a fictitious future network design for a study case Sundom smart grid in Vaasa, Finland, is presented.

#### 4.1. Electricity Market Places for the Finnish Power System

Electricity is traded in the various marketplaces at different times before the actual supply of electricity. The electricity market for the power system consists of the day-ahead, the intraday, and the real-time or balancing marketplaces, which can be considered time windows for physical trading in electricity. For the Finnish power system, the basis of the power exchange, the primary marketplace is the Nord Pool's (Northern Europe power exchange) spot market, the Elspot market, where trades are made hourly a day before (day-ahead) the physical delivery of electricity, and the system price for Nordic is formulated for the next 24 h, giving a base for the other markets' time windows. Next, the intraday aftermarket or correction market of the Elspot trading is the Nord Pool's Elbas market, which aims to trade as close as possible to the actual electricity delivery. The trading closes an hour before the actual delivery of power. Further, for maintaining the power balance during the operating hours, automatic and manual reserves are traded in the Nordic TSOs' (Svenska kraftnät, Statnett, Fingrid, and Energinet) balancing markets [56].

For the balancing energy markets, both up-regulation (increase in generation, decrease in consumption) and down-regulation (decrease in generation, increase in consumption) bids are accepted, and the minimum bidding size of capacities is 10 MW for manually activated (within 15 min) and 5 MW if automatically activated [57]. In the balancing capacity market, the Finnish TSO, Fingrid, ensures that it has up-regulation offers of sufficient quantity for the next day's balancing energy markets. Balancing capacity markets are for additional acquisition of the disturbance reserves activated during the maintenance of reserve power plants. Purchasing is executed weekly, and the capacity is traded for one week at a time. The selected reserve seller is committed to giving up-regulation offers, a balancing capacity offer, in balancing energy markets [57].

Table 2 presents the reserve products and reserve marketplaces for the Finnish power system [51] defined in [58], which are the FCR [59,60], the FRR [61–64], and the FFR [65,66]. Demand elasticity, the demand-side resources (DSR), can be implemented in all markets [67]. Reserve maintenance obligations have been agreed in the joint Nordic system (Finland, Sweden, Norway, and Eastern Denmark) in a network operation agreement between the TSOs. In the Nordic system, the network normal operation mode frequency control is maintained continually with FCR-N agreed to be 600 MW. For disturbance situations such as disconnection of a large power plant, FCR-D is maintained over 1400 MW. Further, for low-inertia situations. The automatic frequency restoration reserve (aFRR) is agreed for 300–400 MW. In addition, the dimensioning faults are covered by maintaining



the manual frequency restoration reserve (mFRR), which each TSO has to size according to a dimensioning fault and balancing deviation in its area.

**Table 2.** Reserve marketplaces in Finland [58,65,68,69].

	FFR	FCR-D	FCR-N	aFRR	mFRR
Volume	Finland 20%, Nordics tot. 0-300 MW (estimate)	Finland 290 MW, Nordics tot. 1450 MW	Finland 120 MW, Nordics tot. 600 MW	Finland 60–80 MW, Nordics tot. 300–400 MW	
Activation	In big frequency deviations In low-inertia situations	In big frequency deviations	Used all the time	Used in certain hours	Activated if necessary
Activation time	0.7–1.3 s	30 s	3 min	In 5 min	In 15 min
Minimum bidding size	1 MW	1 MW	0.1 MW	1 MW	10 MW or 5 MW (if electrical order)
Regulation	Up	Up	Up and down	Up and down	Up and down

#### 4.2. Evolution Phases of the Electricity Distribution Networks

Four evolution phases for the LV distribution networks are proposed in [13]: traditional, self-sufficient in electric energy, microgrids, and intelligent network of microgrids. Further, customer evolution, according to these evolution phases, is defined in [70]. The descriptions of the evolution phases are developed further in this paper, including both the MV and LV distribution networks, and the naming is improved. In the following, a short overview of the evolution phases is given.

The Traditional phase describes the current electricity distribution network status in general, where most of the energy to the loads is fed from the upstream high voltage (HV) grid. In the LV distribution network, some micro-scale DG such as photovoltaic (PV) units can be present in Consumer-Customer premises, but to a small extent. There can be a battery energy storage system(s) (BESS) connected to the PV unit.

The Self-Sufficient phase is reached when the energy production from the DG mostly exceeds the demand for electric energy. Both the micro- (local) and small-scale (regional) DER units increases because consumer-customers aim for self-sufficiency in energy. The consumer-customer is evolved into a responsive customer or even a prosumer [70]. Energy villages or cooperative societies can be formed to produce energy regionally by a small-scale energy generation unit, such as a combined heat and power (CHP) unit. In addition, there can be an MV-connected DG unit, for example, a WT unit, and a BESS can be implemented in the primary substation (PS-BESS) and/or secondary substation (SS-BESS).

The Microgrid phase describes networks capable of operating independently in the island and the grid-connected modes. A microgrid can be formed within a primary or a secondary substation area or within an MV feeder area. In the microgrid phase, customers are more active because of the enhanced opportunities to manage the electric energy and the participation benefits in the ASs. The customer is called a Partner [70]. A microgrid management system (MMS) is needed to monitor and control the microgrid operations and communications to the upstream network controls.

In the Intelligent Microgrid Network, several advanced and different microgrids operate dynamically to meet the smart grids' operational targets. The electricity and the heating are managed as integrated energy systems by distributed multi-generation. Customers become Strategic Partners who operate in a dynamically operated network of microgrids having a more strategic actor role [70]. The operation mode can be selected based on the economic, technical, environmental, or combined modes of various stakeholders in

real-time between all the parties. Hence several operation modes can be selected in the strategic partners' premises [70].

#### 4.3. Sundom Smart Grid

The evolution of a typical suburban or rural area grid in Nordic countries is developed via the Sundom smart grid study case. Figure 3 presents an outline of the fictitious future design for the Sundom smart grid, located in a suburban/rural area. There are around 2500 residential and small commercial electricity users (metering points). The peak power is around 8 MW and increasing since the housing of the area is growing. There is a 3.6 MW WT connected with its own feeder to the MV bus. The current real system is represented on the left side, where the fictitious connections are denoted with dashed lines. There are two primary substations connected between the 110 kV high voltage (HV) bus and the 21 kV MV bus in the futuristic outline of the intelligent microgrid network phase. Both MV distribution networks comprise the feeders supplying electricity to the customers and the feeders to connect the WT and PS-BESS for power supply to the distribution grid and the AS. There are secondary substations along with the MV feeders, which connect 0.4 kV LV distribution networks to the power system. The LV distribution networks include households and small commercial customer types. At the customer premises, there exist DG units and BESS. For heating, the customers use the electric heating systems, which can be direct, partially storing, storing, or heat-pump systems. District heating is available in the suburban area.

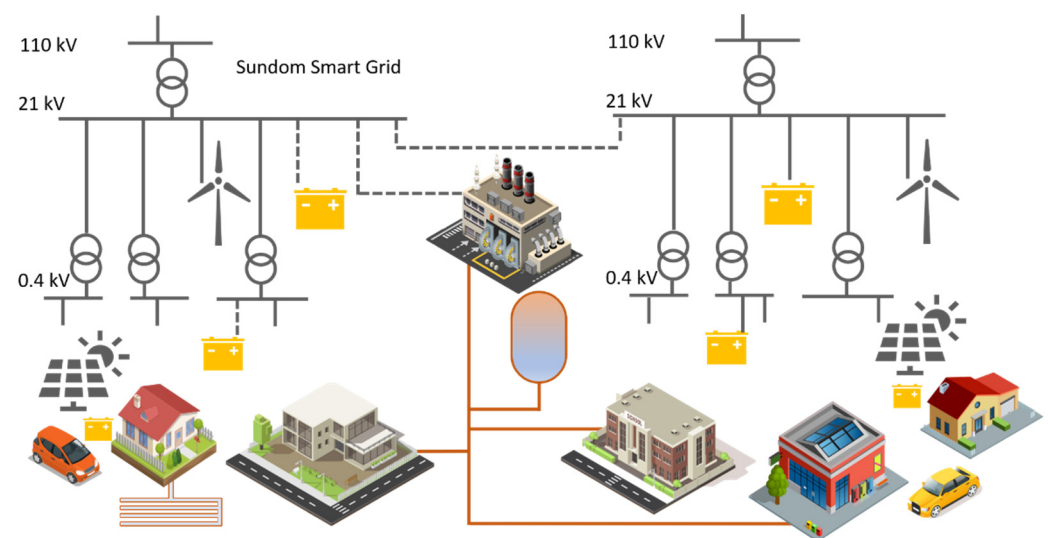

**Figure 3.** Outline of the developing electricity distribution networks, futuristic case of the Sundom smart grid.

This paper focuses on ADNMs through DERs at the different evolution phases of the electricity distribution networks at the location of the Sundom smart grid. In the developed network scenarios, WT, PV, and CHP units are considered the DG units to be used in ADNMs. Controllable loads can comprise loads in the customer premises and a part of the distribution network (e.g., a microgrid). The energy storage systems (ESSs) are considered to be BESS and the district heating storage system. Energy conversion is regarded between electricity and heating and later between electricity and liquid fuel (power-to-liquid-to-power). The primary focus on the AS case studies is the DSM via marketplaces, which can be offered at the first stage by aggregated customers and later by an energy community or the microgrid owners. ASs can be offered for TSO's power balancing or frequency stability support and later evolution phases for voltage control. The second focus is on the local ASs, which are envisioned for the DSO's network management purposes for voltage control. The DG owners, the aggregated customers, and later the microgrid owners can offer local ASs. A probable scenario could also be active power control of the customers' generation

units for the DSO's ASs. However, these cases are not developed in this research and are left to future research.

The following describes the future electricity distribution network operations and management in a behavioral (Section 5) and structural (Section 6) manner. The descriptions use the previously presented review on electricity distribution network development, the definitions of the evolution phases, and the outline of Figure 3. The operational scenarios and the structural representations are developed considering the real distribution network to create a concrete roadmap of the network development and a description of the management architecture schemes. The current system is used to reference which of the future system's scenarios are built by increasing the DERs. The method can be used generally in the roadmap and management system architecture scheme creation, whereas the outcome is representations suitable for similar networks in type and environmental conditions.

## 5. Operational Descriptions of the Future Distribution Networks with the Sundom Smart Grid

The behavioral descriptions, the studied distribution network's operational scenarios in its different evolution phases, are presented by the different levels of UCs [43] in the following paragraphs. The HL-UCs define the main functions of the concepts in the electricity distribution network operation. In this context, the HL-UCs describe the energy management, power balance management, and protection functions. Further, PUCs are developed for describing a particular specialization of an HL-UC. For example, an introduced HL-UC of energy management is load control. A PUC conducted from that can be the economic DR for the load shifting (Self-Sufficient Phase) and the DR for the peak shaving by load shedding (Microgrid Phase).

### 5.1. Energy Management Use Cases

The energy management in the electricity distribution networks generally consists of production planning and control, energy procurement, electricity distribution management, energy demand management, building energy management, maintenance, and communications. DSM measures are used to reduce energy end-use or promote energy efficiency [71], for example, by adjusting consumption temporarily (peak shaving or load shedding). DSM also includes modification of consumer demand for power balancing purposes by transferring consumption from the high load and price hours to more inexpensive hours (load shifting). The DSM can be implemented via various marketplaces to the power system's energy and power balance management. The electricity utilities (in Finland, electric energy sellers, and aggregators) can offer DR capacity to the frequency-controlled reserve, balancing power, fast disturbance reserve, and strategic reserve markets in addition to the day-ahead and intraday energy markets. The implementation of DR is a crucial product considering the flexibility of the future MV and LV distribution networks. The value of DR depends on the accuracy of the estimation, the prediction, and the optimization of demand.

In this research, the HL-UCs of energy management are electricity supply, electricity consumption, load control, electricity generation, generation control, and Volt/VAr control. Energy management covers the power balance management in the active distribution networks [43]. However, the power balance management UCs are presented separately from the energy management UCs for the microgrid phase in Section 4.2.

#### 5.1.1. Energy Management Use Cases of the Self-Sufficient Phase

At the self-sufficient phase, the LV distribution network customers can have a building automation system (BAS), including a HEMS. The BAS can control heating, ventilation, lighting and sockets, sauna stove, water boiler, and security. The home-away function is mostly applied for heating and ventilation, reduced while the residents are away. Customers have increasing micro-generation, which are PV units with or without BESS. The micro-generation unit's maximum output power is 50 kVA, according to the standard EN 50,438 [72]. In Finland, the network recommendations are set for connecting the micro-

generation units maximum of 100 kVA [73]. Notable is that if connecting units based on the three-phase overcurrent protection for the unit,  $3 \times 16$  A, the thermal limit is 11 kVA. The customers mainly aim at PV generation for their own use, but some might be interested in feeding in the utility grid. Three types or roles of customers appear in this evolution phase [70] as follows. Traditionally (in the traditional phase), the customers are just using electricity for their demand, and they are called consumers. In this evolution phase, most customers, called responsive consumers, become more active in the network operation participating in the DR programs with their controllable loads. Third, prosumers emerge increasingly, who own a generation unit and can produce, store, and sell electric energy in addition to the operations of the customer types above.

There can be SS-BESS, and there exists a PS-BESS. A WT unit is located near the substation and connected with its own feeder to the MV bus (see Figure 3). The customers or the energy community obtain a common small-scale generation unit, in this case, a CHP unit for the regional energy generation, aiming for self-sufficiency in energy. The CHP unit is connected to the district heating system. A small-scale generation unit's maximum output power is allowed to be 2 MVA [74,75].

A central energy management system (CEMS) over both voltage levels monitors the CHP unit's energy flows. The BESS units' and the customers' demand can be monitored, and the utility network for cost and compensation fee calculation purposes. Smart energy meters measure the energy consumption in the customers' premises and the secondary substation areas. A measuring unit for the generation from the CHP unit is required.

The HL-UCs for energy management over the LV and the MV distribution networks in the self-sufficient phase are described in Table 3.

**Table 3.** Energy management high-level use cases in the self-sufficient phase.

HL-UC Name	Events in the LV and MV Distribution Networks
Electricity supply	LV: Electricity is supplied to the customers' grids by the DSO and the energy retailer. The DSO provides voltage to the customers' main distribution board. It measures the consumed energy via smart energy meters for billing purposes (the energy retailer's energy charge and the DSO's transmission charge).
	MV: Electricity is supplied to the LV customers via the MV distribution network. The DSO measures the consumed energy in the LV distribution grid at the secondary substations.
Electricity consumption	LV: Customers consume electric energy in several ways. The most significant loads are electric heating, boiler, stove, sauna stove, lighting, ventilation, and heat pumps. The EVs, the PV-BESS, and the SS-BESS consume electricity while charging. The BESS inside the EV (EV-BESS) is considered a passive load in this phase.
	MV: PS-BESS consumes electricity while charging.
Load control	LV: The loads are divided into non-controllable and controllable, in which controllable are passive type loads, such as heating, boiler, heat pumps, and EVs. The controllable loads are used for the demand response (DR) programs by the aggregators, who can be "a market participant that combines multiple customer loads or generated electricity for sale, for purchase or auction in any organized energy market" [76]; in this study, they are called retailer-aggregators. CEMS can be used for a cluster of households by controlling the loads centrally as an option in DR, for example. In this case, the retailer-aggregator also sends the price signal to the CEMS. An SS-BESS can offer a controllable load with storage (charging) for the DSO's local ASs. For example, the summertime situation can be high PV generation and low consumption, which can cause the voltage rise, and by charging the SS-BESS, the voltage can be decreased in the network. Alternatively, an SS-BESS could be offered to be aggregated for the TSO's ASs via the marketplaces.
	MV: The PS-BESS can offer frequency stability support operations as an FCR via marketplaces (for example, store excess energy).

Table 3. Cont.

HL-UC Name	Events in the LV and MV Distribution Networks
Electricity generation	<p>LV: The micro-generation is PV generation at the consumers' premises. The operation of the PV units can be separated, class 1 and class 2 equipment [77], from the LV distribution network, or the operation can be parallel with the LV distribution network, but the power flow to the distribution network is prevented by class 3a equipment [77]. In these cases, the purpose is to minimize the customers' electricity bills, as in the traditional phase. PV units also exist, which can supply energy to the distribution grid either without fees, class 3b equipment [77], or with fees, class 4 equipment [77]. The SS-BESS could also offer recharging operation in the local ASs for the DSO's congestion management. For example, in high demand time, the voltage can fall in the weak network parts. Alternatively, the SS-BESS could be obtained for gaining benefit by offering it as a resource for ASs via markets.</p> <p>MV: PS-BESS (as a generation unit) can provide back-up power for the energy community's consumers and the operations as a frequency control reserve. The CHP unit provides heat and electricity.</p>
Generation control	<p>LV:</p> <p>MV: The CEMS controls the electricity generation of the PS-BESS for self-sufficiency purposes. The CEMS monitors the generation from the WT and controls the CHP. The CHP unit is controlled so that heating energy is guaranteed (heat-led control/maximum heat output) for the connected residences. The electricity is treated via the PS-BESS and shared. The excess heat that is not used in the region/community is fed in the utility district heating system.</p>
Volt/VAr control	<p>LV: In the traditional and the self-sufficient phases, the LV distribution networks' voltage control is passive; off-load-tap-changers exercise it in the secondary substations.</p> <p>MV: Generally, for managing the voltage within the permitted limits, reactive power is controlled via on-load-tap-changers (OLTC) of the primary transformer. Additionally, in this phase, the reactive power flow from the full-scale converter of the large-scale WT (3.6 MW) owned by a DG partner is controlled for the DSO's ASs [78,79].</p>

The load control HL-UC can be studied further by generating, as an example, the economic DR for the load shifting PUC. Generally, load shifting means a reduction in electricity consumption, while an increase in demand follows later when the electricity prices are lower. There are two basic options for the DR programs [80,81]: the price-based programs (PBP) and the incentive-based programs (IBP). The PBP programs are based on dynamic pricing, where the electricity prices vary according to the real-time cost of electricity. The PBP programs include the time-of-use (TOU), critical peak pricing (CPP), extreme day CPP (ED-CPP), extreme day pricing (EDP), and real-time pricing (RTP) programs. The IBP programs are divided into the classical load control programs and the market-based programs. In the classical IBP, the customers receive participation fees (an invoice credit or a discount rate) for their involvement in the programs. In the market-based programs, participants are rewarded with money, depending on the amount of load reduction. The classical IBP includes direct load control programs (DLC) and interruptible or curtailable load programs. The market-based IBP has programs of demand bidding (DB), emergency DR, capacity market (CM), and AS markets.

Some PBP programs are generally applied in suburban (and rural areas) in the current electricity distribution networks. The IBP programs, direct control, load curtailment programs, and DB are applied traditionally to industry loads in high-demand times. In this case study, no industry buildings are in the area, so these are neglected. Instead, the market-based IBP aggregated load control programs via DR marketplaces are the feasible options, which could be AS market programs. Hence, the economic DR for load shifting by

load curtailment PUC was developed over the LV and MV distribution networks, and it includes the following UCs:

- DR via TOU (electricity storage heating and other passive loads): The houses with an electric storage heating system use TOU pricing with two time-blocks per day, which is currently (the traditional phase) used as the primary case in the electricity storage-heated houses. The consumption can be changed from the peak load times to off-peak times. The off-peak is at night with a lower rate, and the peak is at daytime at a higher rate.
- DR via RTP (passive loads): An option is RTP programs used in customers who want to be charged based on hourly fluctuation of electricity prices, reflecting the wholesale market's electricity cost. RTP customers are charged based on hourly fluctuating prices announced a day or an hour ahead (based on the base market, Elspot or Elbas, prices).
- DR via AS markets (electricity storage heating and other passive loads): A demand aggregator collects the demand flexibility, carries out the DR optimization and scheduling, trades on the energy markets, calculates the consumers' price-volume signals, and finally sends the price signal to the customers. Customers exploit the retailer-aggregator's price signals to decide energy consumption (by the agreed option). Hence, the HEMS displays the electricity price and the consumed energy volume and controls the loads according to the approved option. The demand aggregator is a retailer-aggregator, which is an existing market participant, the energy supplier [82–84]. The retailer-aggregator collects the demand flexibility from the passive type of loads and offers the aggregated loads for the day-ahead market Elspot (0.1 MW/12 h) [85] or intraday market Elbas (0.1 MW/1 h) [86]. An option is to participate in the TSO's organized power system reserves in balancing energy markets with either up-or down-regulating bids [86], in FCR-N [85] (0.1 MW,  $\leq 3$  min), but likely also in FCR-D (1 MW,  $\leq 30$  s).

#### 5.1.2. Energy Management Use Cases of the Microgrid Phase

The microgrid is considered to be formed within the MV distribution network area. The energy management HL-UCs of the microgrid phase are similar to the self-sufficient phase. In the microgrid phase, customer types of the previous evolution phase exist (consumers, responsive consumers, prosumers) and a new customer role, the partners. Partners own the previous customer type characteristics, but they also have controllable dynamic loads, and they are active in AS programs through their resources. The dynamic loads are the EV-BESS of the vehicle-to-grid (V2G) and vehicle-to-home (V2H) type of the EVs. The V2H type can supply electricity to a small microgrid such as a house and act as a power source during a power outage (or mobile outdoors).

EV aggregators can provide services to the base and the peak power markets, the AS markets (reserve market), and offer additional storage and back-up power [87]. Hence, participation in the AS markets is a regular operation. The EV client types in the suburban area are assumed to be type 3 or 4, according to [87]. Type 3 EV owners provide the EV-BESS as a controllable load, in which charging location and time are known. Type 4 EV owners provide the EV-BESS as a controllable resource, V2G, assuming that the aggregator has contracted a specified amount of battery state-of-charge (SOC). The EV owner defines the charging volume, the available period of charging, the minimum battery SOC level for the next hours (or days). The EV aggregator gathers real-time information about the status, frequency, total capacity, and voltage of the controllable area.

The micro and the small-scale generation units are connected to the utility network by the devices and contracts, which allow the two-way power flow with payment of the energy surplus. The common CHP unit could be deployed to provide various ASs such as intraday balancing services, improve power quality, and provide black start services. The CHP unit could be used for DR purposes by controlling the power output (and the water temperature) by the energy management system (EMS) based on the DR optimization

problem. In the future, the CHP unit could be coupled to a heat storage system, whereas it could provide flexibility in a generation such as is presented in [88].

Moreover, a higher-level control system is required, responsible for the regional DSM or DR, the energy and power balance management, and the protection management both in the grid-connected and the islanded operation modes. In this paper, the microgrid management system (MMS), including a microgrid energy management system (MEMS) and a microgrid protection management system (MPMS), is considered, of which functions are analyzed in [43].

The HL-UCs for energy management of the LV and the MV distribution networks in the microgrid phase are described in Table 4. Only the new events are presented compared to the previous, the self-sufficient phase.

**Table 4.** Energy management high-level use cases in the microgrid phase.

HL-UC Name	Events in the LV and MV Distribution Networks
Electricity supply	LV: In the islanded operation mode, the energy supply is provided by the microgrid owner or operator, who is the local DSO, which is a natural case with the utility-connected microgrids. The electricity is supplied to the loads from the customers' PV units and BESS within the islanded microgrid.
	MV: The microgrid operator is responsible for providing electric energy that is safe and high quality in the islanded and grid-connected mode.
Electricity consumption	
Load control	LV: The dynamic load types are used for the DR programs. Independent aggregators, "an aggregator that is not affiliated to a supplier or any other market participant" [76] or "a market participant engaged in aggregation who is not affiliated to the customer's supplier" [89], emerge. A third-party, independent aggregator, an EV aggregator, can collect the flexibility from charging or discharging EVs. In the islanded mode, loads are controlled by the MEMS for maintaining power balance in the microgrid.
	MV: MEMS is responsible for charging the PS-BESS in the grid-connected and the islanded modes. In the islanded operation mode, the PS-BESS is the primary resource to be controlled for maintaining power balance in the microgrid.
Electricity generation	LV: The SS-BESS can be used for power balance management in the islanded mode.
	MV: In the islanded mode, the generation from PS-BESS is controlled by MEMS for maintaining power balance in the microgrid.
Generation control	LV: The electricity generation from the class 4 PV units can be controlled to maintain the supply quality. The prosumers and the partners can agree with the DSO or the microgrid operator to control their PV unit's active power generation for congestion management purposes. The frequency-controlled micro-generation units can offer frequency support in the islanded mode.
	MV: In the grid-connected and islanded modes, the MEMS controls the share of generated heat and electricity from the CHP unit according to its optimization target. In addition, the PS-BESS recharging is controlled via MEMS. In the islanded operation mode, the MEMS is also responsible for the WT's generation control.
Volt/VAr control	LV: The reactive power can be controlled for the DSO's local AS purposes; the customer PV units and BESS and the SS-BESS can be used for maintaining the quality of the supply. There can be an OLTC at the secondary substations.
	MV: In the grid-connected mode, voltage and reactive power are controlled the same way as in the previous evolution phase, but also, the PS-BESS and the CHP unit can be used.

Based on the load control HL-UC, the DR for the peak shaving by load shedding PUC description can be developed for the energy management over both voltage levels. Peak shaving is a quick reduction of the power consumption for a short period, the activation of the generation, or the battery. In this HL-UC, the customers belong to the energy community, but in reality, not all customers might join the energy community. Responsive consumers, prosumers, and partners can reduce power consumption by load shedding to avoid spikes in consumption in the LV distribution networks and the microgrid area. In the MV grid, the CHP unit and the PS-BESS can be used for supplementing power to avoid peak loads. The LV- and MV-connected DG units are connected to the MEMS, which controls the DG units centrally within the microgrid area. In the island operation mode, the MEMS behave like a retailer-aggregator, sending the price signal to the CHP unit's EMS and the customers' HEMS to be exploited. The MMS (MEMS) can send direct load control signals to the customers to secure the network's reliable operation. The DR for peak shaving by load shedding PUC was developed over the LV and MV distribution networks, and it includes the following UCs:

- Economic DR via AS marketplaces: In the customer's premises, the HEMS displays the energy signals to the responsive consumers, prosumers, and partners to decide consumption and electricity generation and supply to the distribution grid (prosumers and partners). The HEMS (at the customer connection point) and the MEMS (at the POI of the microgrid) monitor the energy flows. The HEMS generates forecasts of the load based on the history data and the generation forecasts based on the weather forecasts. The MEMS optimizes the power to be consumed or generated within a microgrid area depending on the energy community's agreed AS programs, market prices, and the network's security.
- Generation activation: The electricity generation of the energy community's CHP unit and the PS-BESS can be controlled to produce more electricity to flatten or reduce the distribution grid's peak demand (can be for the TSO's or the DSO's load shedding).
- DR from the frequency responsive reserves and intermittent generation: The retailer-aggregator collects the demand and generation flexibility and agrees on using them within the microgrid with the energy community. The loads can be collected for the FCR-N reserves (0.1 MW,  $P_{100\%}$  in 3 min [60]). In addition, an option is the FFR reserves (1 MW, 49.6 Hz in 1.0 s [66]) for the inverter-connected dynamic loads, that is, various BESS units, but also controllable loads having an enhanced controller as studied in [90], for example. In this study, they are called smart loads.

### 5.1.3. Energy Management Use Cases of the Intelligent Microgrid Network Phase

In this phase, the different energy sectors are coupled, and they operate flexibly interlinked via different energy conversion devices; hence, the conversions of power-to-X-to-power are reality. The power system, the smart grid, is the backbone of the whole energy system [3,4,91].

The integration of various microgrids and optimizing their operation as a regional basis enables the electricity distribution networks to operate as a building block of the smart grids. In the intelligent microgrid networks, electricity and heating are managed and integrated, and the operation strategy can be chosen from the different operation modes [26,92], such as economical, technical, and environmental.

The central microgrid management system (CMMS) behaves as an energy retailer over several regional MMSs and CEMSs [13] and cooperates with the different aggregators and suppliers of energy. The CHP unit is connected to heat storage (HS), which acts as the seasonal heat storage [93]. The customer roles are like in the previous phases, but, increasingly, Strategic Partners appear. The strategic partners operate actively in the dynamically operated energy networks, meaning that the operating strategy can also be chosen in the strategic partners' premises. The customers' load types can be passive and dynamic (the smart and the frequency-controlled loads), like in the microgrid phase. Several independent aggregators can collect the customers' flexibility, in addition to the



retailer-aggregator. There can be dedicated aggregator roles for the ASs such as a PV, a BESS, an EV, or an energy community aggregator.

The HL-UCs are similar to the previous evolution phase, except that new actors are the strategic partners, the CMMS, and the various aggregators. In addition, new actors from the other energy systems are interlinked to the intelligent microgrid network for optimizing the operation of the whole energy system both in the normal operations and in the disturbance situations of the backbone or the power system. The studied HL-UCs for energy management of the LV and the MV distribution networks in the intelligent microgrid network phase are described in Table 5. Only the new events are presented compared to the previous, the microgrid phase.

**Table 5.** Energy management high-level use cases in the intelligent microgrid network phase.

HL-UC Name	Events in the LV and MV Distribution Networks
Electricity supply	
Electricity consumption	
Load control	<p>LV: The controllable loads used for the DR programs are passive and dynamic load types, from which several independent aggregators can collect various controllable loads: electric heating systems, water boilers, ventilation, various customers' BESS, and the SS-BESS.</p> <p>MV: Load control within a microgrid is as in the previous evolution phase. In this phase, a single microgrid can be considered a controllable load to be controlled to reduce or eliminate its demand even by intentional islanding. Load control by a microgrid set can be optimized for the DSO's congestion management or the TSO's ASs.</p>
Electricity generation	<p>LV: Several independent aggregators can collect power from various generation units: customers' BESS (as a generation), PV units, and the SS-BESS.</p> <p>MV: Grid-connected microgrids can be operated to supply electricity to the utility grid.</p>
Generation control	<p>LV:</p> <p>MV: A grid-connected microgrid can be operated as a flexible generation unit.</p>
Volt/Var control	

The HL-UCs for energy management of the MV distribution network in the intelligent microgrid network phase are presented in Figure 4, and they relate to the total energy system's HL-UCs, which could be:

- Electricity conversion to heat: Power to heat (PtH) conversion is made in the electricity surplus situation or the low electricity price time. The excess heat is stored.
- Electricity conversion to liquid: Power to liquid (PtL) conversion is made in the electricity surplus; the liquid is stored in liquid storage, and it can be used as fuel for a generator set (Genset).
- Liquid conversion to electricity: Liquid to power (LtP) conversion is made in the case of electricity demand. The liquid(s) can be used as fuel for Gensets.

Based on the load control HL-UC, the economic DR for load shifting by load curtailment PUC and the DR for peak shaving by load shedding PUC are applicable the same way as in the microgrid phase. Both of them are flexibilities that could be used in the base power markets, Nordpool's day-ahead and intraday markets, the TSO's balancing and reserve markets, and the DSO's local ASs. Overall, various PUCs of ASs could be developed in this evolution phase since a microgrid can be considered a dynamic load (and generation) reserve shaped in different voltage levels.

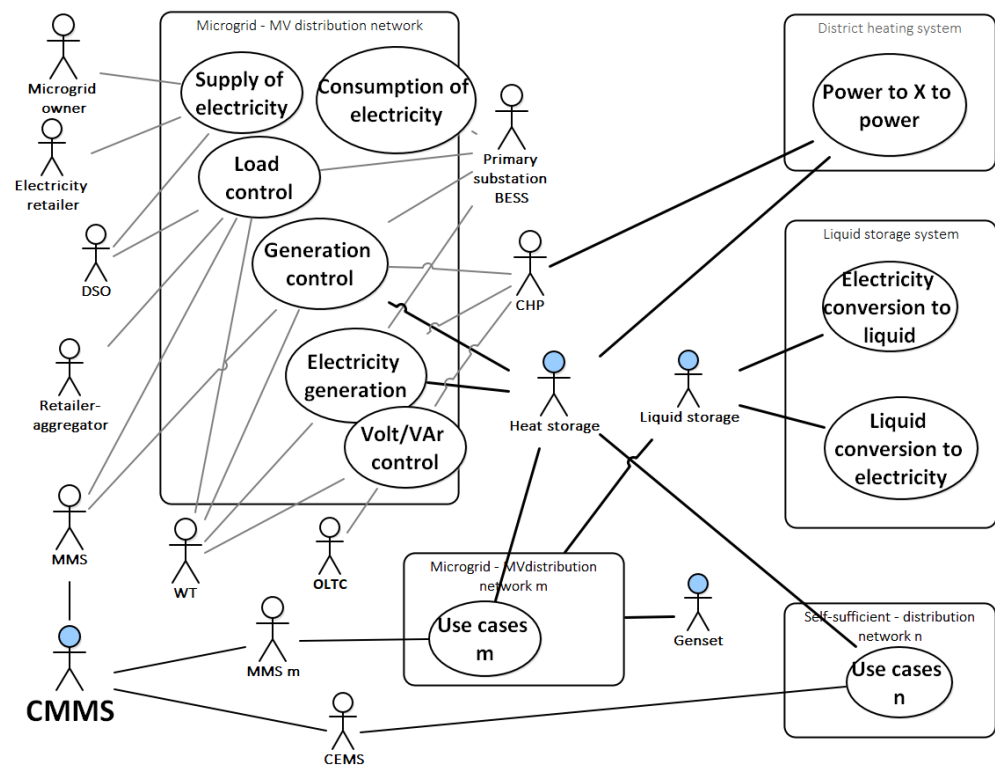

**Figure 4.** High-level use case diagram of energy management of the MV distribution network in the intelligent microgrid network phase.

Further, considering the operational scenarios of the various flexible resources from the different voltage levels, a responsive generation control PUC could be developed for the electricity generation HL-UC. Similarly, a responsive demand control PUC could be developed for the electricity consumption HL-UC. In these circumstances, these PUCs could be combined and named the flexibility control PUC. It would be worth exploring whether the flexibility control could be a new concept level building block presenting a new HL-UC for future power systems' energy management.

Like previous chapters, we can derive UCs for all evolution phases, but in the following, the focus is only on the microgrid phase, as presented in Figure 1.

### 5.2. Voltage and Frequency Control via Power Balance Management Use Cases of the Microgrid Phase

Power balance management aims to maintain the power system frequency that results from the balance between electricity production and consumption. The demand can be predicted, but deviations occur due to unexpected load variations, fluctuation of the renewable generation, or disturbances. Power balance management and a hierarchical control strategy are required for the microgrids [94] because of the autonomous operation requirements. In microgrids, the system's stability is achieved by optimizing active and reactive power flows through the DG units, the BESS units, and the controllable loads. The BESS system should support the microgrid reliability and efficiency. The loads have to be classified and prioritized for demand flexibility. In the grid-connected mode, the power output of DG and BESS units is to be optimized. The controllable loads are committed according to the requirements of the energy markets in which they participate. Considerable is the limit of the active and reactive power flow at the POI without losing the possibility of safe islanding operation.

The DSOs are in charge of the safe power supply in the electricity distribution networks, and they have the control and management systems for that. For the utility-connected microgrids, the dedicated functions and functionalities have to be integrated with the existing control and management systems, at least to some extent. For example,

Chuang and McGranaghan [95] present the functions and the functional requirements for a controller that manages the local generation, the storages, and the controllable loads, and the smart switches control the normal, emergency, and island operation modes. They present two functions: the local grid reconfiguration and the optimization functions related to economic, environmental, and customers' comfort. These can be considered as energy management functions and power balance functions operated by the MEMS in the microgrids [43]. If there is an OLTC in the secondary substation, it can be used for active management [96–98]. The DSOs (or the microgrid operators) must have permission to configure the alarm settings, rank the load priorities with the customers, enter the profiles, and configure the regional generation [95].

The power balance management in microgrids is presented in [94,99], consisting of four control levels, according to the standard IEC 62264. Hierarchical control of microgrids is also presented in [100], according to the ANSI/ISA-95 standard. All four control levels manage the power balance, but the highest level, the tertiary control, is not used in the island operation mode. The basic operations in the hierarchical control of microgrids are described and presented by the UCs in the following.

The internal control or level 0 manages the operating point between the DG and the BESS units and their interfacing devices or the power electronic interface [94]. These interfaces can be classified into the current-source inverters (CSIs) and the voltage-source inverters (VSIs) [94]. The CSIs are used for injecting current to the grid, and the VSIs for maintaining stable voltage in the grid [99]. Further, the VSIs are connected to the BESS, typically using droop control. The CSIs are connected to the PV or WT generation units, which require the maximum power point tracking (MPPT) algorithms [99].

The primary control or level 1 is responsible for regulating the voltage (frequency and amplitude) delivered to the zero-control level [94,99]. There are different methods to regulate the voltage within the microgrid. In addition to the active load sharing (usually in the islanded mode), the most common control is the droop-based control (grid-connected mode typically) for regulating the active and reactive power consisting of the active power/frequency ( $P/f$ ) and the reactive power/voltage ( $Q/V$ ) droops. The primary control's tasks are to stabilize the voltage and frequency after islanding, guarantee interconnection capability for DERs, share the active and reactive power between DERs (even without communications), and reduce circulating currents [101]. The primary control manages the power balance between the central BESS and the inverter-connected DG and BESS units. In addition, frequency-controlled load types such as the dynamic loads, for instance, V2H or V2G, can be worthwhile to connect to the primary control system.

The secondary control or level 2 is responsible for correcting the grid frequency and amplitude deviations. A (central) controller is needed for regulating voltage and frequency deviations toward zero after any change in demand and generation within the microgrid [99]. The secondary control's tasks are to compensate for the voltage and frequency deviations after primary control actions, for the reason the BESS cannot provide long-term power control [101]. Without this control, both the frequency and amplitude of the voltage would depend on the loading [94]. The frequency and voltage at the DERs' terminal are compared with the reference values sent by the primary controllers, and the deviation or the error values are sent to the primary controllers for compensation [101].

The tertiary control or level 3 is responsible for optimizing the power flow in the microgrid and the power flow between the microgrid and the utility or main grid. The tertiary control also enables electricity suppliers' and aggregators' participation in the electricity markets. This control level is responsible for managing the active and reactive power flows through POI by regulating the voltage and frequency in the parallel operation mode [99]. The active and the reactive power are compared with the reference values at the POI. The active power flow at the POI can be controlled by adjusting the reference frequency in the grid-connected mode [94]. An islanding detection algorithm is needed to disable the tertiary control for detecting islanding [99].

The microgrid frequency and voltage are managed mainly by the power electronic interfaces and BESS (although direct load control affects power balance, it is not desirable in the first place). The power converters of DER units can be divided into grid following (controls current and phase angle), grid forming (controls voltage magnitude and frequency), and grid supporting based on their functioning types. Grid following inverters (CFLs) are connected with non-dispatchable DG units, and they operate as a CSI with a unitary power factor ( $\cos \varphi = 1$ ). This inverter requires a voltage reference, and it tracks the grid by injecting current in phase with the grid voltage. The maximum MPPT algorithm modifies the operating point (voltage or current) of a micro-source by the DC/DC converter that sends the DC power to the inverter. The CFLs operate similarly in the grid-connected and islanded microgrid. The grid-forming inverters (GFM) are connected with the BESS units. In the grid-connected mode of the microgrid, the GFMs tasks control the active and reactive power injected into the AC bus to maintain the SOC of the BESS and improve the power quality. They generate voltage on the bus in the islanded mode, thus acting as a VSI. The GFM usually uses the  $P/f$  and the  $Q/V$  droop control methods. The grid supporting inverters (GSIs) aim to maintain the power quality in the islanded microgrid by supplying active and reactive power with the droop controllers. The GSIs can be connected with the dispatchable DG units and the BESS units [102].

The BESS control is essential in the microgrid's power balance management and AS. The AS can be load-following, operational reserve, frequency regulation, peak shaving, black start (during island operation mode), and integrating renewables. The power balance within a microgrid can be maintained by charging or discharging the stored energy. The BESS controls the charging power by increasing it if the grid's frequency exceeds the maximum value and decreases it when the frequency reaches the minimum setpoint. The central BESS is fundamental for the voltage control in the island operation mode due to the dynamic variations such as the delayed response or some DG units' slow controllability. In this case, the BESS contains the primary and the secondary control levels only. The BESS monitors active power in the microgrid, where the system's frequency reflects the system's capacity. Each DG unit's power setpoint should be controlled through the secondary control level to maintain the BESS's zero power output [94].

In this study, the power balance management in the microgrid phase is reviewed both in the parallel and island operation modes. The OLTC, the PS-BESS, the SS-BESS, the DG units, and the controllable loads can contribute to the active voltage level management. The studied power balance management HL-UCs of the LV and the MV distribution networks in the microgrid phase are described in Table 6.

**Table 6.** Power balance management high-level use cases (HL-UCs) in the microgrid phase.

HL-UC Name	Events in the LV and MV Distribution Networks
Regulate the output voltage and control the current of the inverter-connected DER	LV: The primary control actions of each inverter module. The inverters are associated with the dynamic loads EV-BESS, PV-BESS, class 4 PV units, class 3 b PV units, and SS-BESS. The PV and BESS inverters can be either GFL or GSI units. The control and monitoring can be executed via BAS and HEMS.
	MV: The primary control actions of the PS-BESS, the CHP, and the WT interfacing units. The primary control has been in use since the self-sufficient phase in Volt/Var control, aided by the OLTC of the primary transformer, the WT converter, the CHP unit, and the PS-BESS. In this phase, the BESS, the CHP, and the WT unit can be used as the GFM units.
Regulate the active and reactive power	LV: The secondary control actions to keep the system stable. The deviations in voltage (amplitude and frequency) between the dispatchable DER units and the grid are regulated. The controllable loads, PV inverters, the OLTC of the MV/LV transformers, and the SS-BESS can balance the power. The SS-BESS behaves as a GSI unit.

Table 6. Cont.

HL-UC Name	Events in the LV and MV Distribution Networks
	MV: The secondary control regulates the voltage deviations of the WT, the CHP, and the PS-BESS. In addition, the OLTC can be connected to the power balancing in the grid-connected mode. For example, during the high generation and low consumption time, the voltage level can rise in the LV grids and highly cabled MV grid, in which case the PS-BESS (and SS-BESS) can be charged.
Control power flow at the POI	LV: MV: The MEMS is in charge of the tertiary control in the grid-connected mode aiming to provide the setpoints for active and reactive power flows at the POI according to the microgrid's operational target
Seamless switching between the operation modes	LV: MV: The MEMS is responsible for synchronizing the different control loops, thus enabling smooth transitions between the different operation modes. The secondary controller includes the synchronization control loop for the switching between the islanded and grid-connected modes.

Further, the seamless switching between the operation modes HL-UC in the power balance management can include the following PUCs: intentional transition to the islanded operation and unintentional transition to the islanded operation; while the control power flow at the POI HL-UC in power balance management can include the following PUCs: microgrid provides voltage control service and microgrid as a resource in the congestion management.

### 5.3. Protection Use Cases of the Microgrid Phase

In the microgrid phase, protection is considered for the MV and LV distribution networks, which both can form a microgrid. In this instance, the analogy of the microgrid area protection is intended for both voltage-level microgrids. In connection with the MMS, the MPMS is responsible for the microgrids' protection coordination. The protection system is adaptable depending on the microgrid's operation mode (grid-connected or island) and, if necessary, on the production and demand changes. The MPMS must react to various fault situations in both operation modes.

The LV microgrids' protection system could be based on the combination of current and voltage measurement because the inverter-connected DG units can cause the short circuit current to be low and delay the operation of a protection device (PD). The LV feeder protection can be implemented by circuit breakers (CBs) with electronic trip units. The electronic trip units can measure voltage, current, and frequency on which the different protection functions are based. The protection functions can be against overcurrent (OC), directional OC, earth fault, phase unbalance, under/over frequency, under/over voltage, and power reversal. Timestamps of the event data are used to log the events in the correct sequence [96].

In this study, the operational scenarios are developed regarding OC protection. Figure 5 presents an exemplary outline of a microgrid in the Sundom smart grid area. The microgrid is considered to be formed within the MV distribution grid (or the LV distribution grid). There are PDs located in the MV or LV distribution networks. The numbering of the PDs carries the analogy of a microgrid. PD0 and PD1 are marked as (0) and (1) in the primary substation (and the secondary substation), whose function is to isolate the microgrid from the utility grid during the fault conditions in the supplying feeder (F1). The (1) includes the microgrid main switch, or it is connected to control the microgrid main switch. PD2s marked as (2) are for the MV (or LV) feeder line protection against the fault F2, and they are capable of performing adaptive protection functions based on a command from the MPMS to change their protection settings. The PD3Cs marked as (3C) are for the LV feeder line protection against fault F3, and they are CB-based devices. The PD3Fs

marked as (3F) are for customer installation protection, and they are traditional fuse-based devices. The PD4s marked as (4) are the protection devices for the DG units.

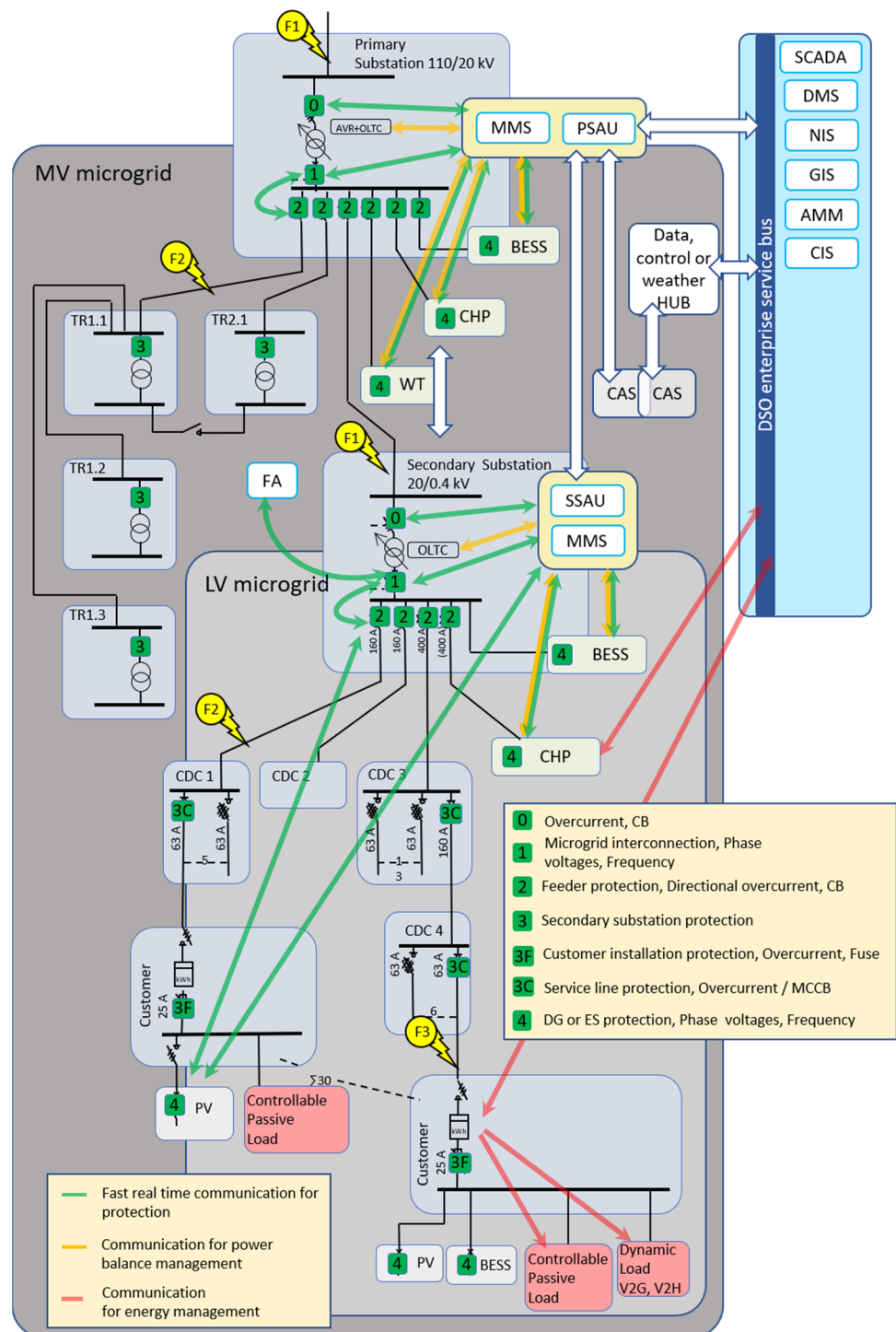

Figure 5. The suburban distribution network in the microgrid phase. Adapted from [13].

The selectivity of the protection system in the MV (and LV) distribution network is established as follows [43,96,103,104]:

- The function of the PD0 is to isolate the substation from the utility grid during the line fault (F1) conditions. The PD0 is connected to the transformers' secondary side relay PD1. PD0 sends a transfer trip command to PD1 to isolate the secondary side of the transformer.

- The secondary side relay PD1 is part of the MV (or the LV) busbar protection and also operates as the POI of the microgrid. The PD1 includes the loss-of-mains (LOM) protection, an islanding detection algorithm in the F1 situation. When the HV (or MV) is feeding line-voltage drops under the acceptable limit, the PD1 disconnects the microgrid from the utility grid. In addition, the PD1 can receive a disconnection command from the PD0 in the primary substation (or the MV feeder automation (FA) system in the secondary substation). In the F2 or the F3 situations, the PD1 receives an interlocking signal from the PD2 after the pick-up limit is reached.
- The PD2s operate only in the F2 situations, and they include directional OC protection, which is selective with the PD1 and the PD3s in the MV grid (or the PD3C in the LV grid). After the PD2 is operated, it sends a disconnection signal to all PD4s of the corresponding feeder.
- The PD4 has to be voltage selective with the PD1 and the PD2 and frequency selective with the PD1. In the F2 situation, PD4 receives the disconnection signal from the PD2. In the F1 case, if the microgrid is not capable of islanding, the PD4's LOM protection operates, or the PD4 receives the disconnection signal from the MPMS.
- The PD3Cs are selective with the PD2 and the PD3F, and PD3Cs protection settings are fixed and based on the microgrid island mode (more critical). Thereby, the communications between the PD3Cs and the MPMS are not necessary.
- The PD3Fs operate in the F3 situations and the customer grid fault situations, and they are selective with the PD2 and the PD3C. No communications are required.

The studied OC protection HL-UCs of the MV and the LV distribution network in the microgrid phase are described in Table 7.

**Table 7.** Protection management high-level use cases in the microgrid phase.

HL-UC Name	Events in the MV and/or LV Distribution Network
Fault in the supplying feeder (F1), microgrid transfer to the island operation mode	In the fault F1 situation at the HV feeder, the MV (or the LV microgrid) is required to disconnect from the faulted feeder line, so an islanding detection method, such as the rate of change of frequency (ROCOF) relay, is required. The PD0 disconnects the transformer's primary side, and the microgrid switch (by the PD1) at the secondary side isolates the microgrid from the utility grid. The PD2s adapt to the protection settings of the island operation mode. The MPMS's adaptive protection calculation algorithm calculates new protection setting values for the PD2s based on the type, the state, and the production capacity of the DG units.
Fault F1 cleared, microgrid transfer to the parallel operation mode	After clearing the F1, the DMS sends the permission of utility grid reconnection to the MPMS (MMS). The PD1 measures the reliable recovery of supply (voltage amplitude, phase, and frequency) and sends this information to the MPMS. The MPMS sends to the PD1 the permission for synchronized reconnection (based on the permission, the reliable voltage recovery information from the DMS). After the synchronized reconnection, the MPMS sends commands to the PD2s to apply the renewed protection settings.
Fault in the MV or LV feeder line (F2) in the parallel or the island operation mode	In the fault F2 situations, the PD2 detects the directional fault current and other PD2s see the fault in the backward direction. After that, it sends disconnection commands for the PD4s connected to the faulted feeder line. The PD2 operates to isolate the fault after a short (20 ms) delay after sending the disconnection commands for the PD4s. Finally, the PD2 sends the event data with timestamps to the MPMS. Settings for the PD2s in the MV and LV feeder need to be properly selective.
Service restoration after F2 repair in the parallel operation mode	After the repair of the F2 is completed, the serviceman checks the protection settings for the PD2 from the MPMS. For example, setting the PD2 to the test position requests the set values from the MPMS. After receiving the latest protection setting values, the PD2 can be connected to the line, and the MPMS sends the connection request to the PD4s.

Table 7. Cont.

HL-UC Name	Events in the MV and/or LV Distribution Network
Service restoration after F2 repair in the island operation mode	This function is similar to the parallel operation mode. In addition, the MMS coordinates the operation between the MPMS and MEMS and permits the PD2 to reconnect the feeder.
Fault in the LV customer service line (F3)	The PD3Fs operate to isolate the customer installation from the faulted LV distribution line. The LOM of PD4s operates, disconnecting the DG and BESS units from the grid.
Service restoration after F3 repair in the parallel and island operation modes	After clearing the F3, the customer installation, the DG units, and the BESSs can be reconnected to the grid.

## 6. Structural Description of the Future Electricity Distribution Networks

The actors represented in the UCs can be the persons, devices, systems, and events presented in Section 2. However, in this section, actors are studied more closely: an actor represents a role, and a role is a kind of position in a task. The previously defined actors are classified to generalize their roles, and further, the classified actors with their associations are presented with the class diagrams. Table 8 presents the classified actors based on HL-UCs of the energy management, power balance management, and OC protection in the developing electricity distribution network from state of the art (traditional) to the intelligent microgrid network phase. Only the new classes are presented compared to the previous phase, and the classes are aligned with the NIST conceptual domains.

Further, the classified actors are presented in more detail with their associations in Figure 6, which presents the class diagram that is developed by combining the following class diagrams of the microgrid phase: Figure A1, presenting energy management, in which white classes exist in the traditional phase, light blue classes emerge in the self-sufficient phase, and blue classes emerge in the microgrid phase; Figure A2, presenting the power balance management system; and Figure A3, presenting the OC protection system of the microgrid phase.

The classes, which are illustrated in blue, are classes participating in energy management. The green classes are for power balance management, and the red classes are for protection. The classes illustrated in white present the other classified actors associated with the basic distribution system and operations. The classes are assigned to the conceptual domains defined in [16] and [18]. The classified actors have attributes and operations; the attributes define values attached to a class. The operations are the operations that a classified actor can perform or can be addressed to them. For example, in the UML terms, a customer object in the customer class (classified object/actor) has its value of the connection capacity, that is, an attribute. Further, a customer's operations can be: consume energy, produce energy, and assign loads for DR purposes. Furthermore, the static relationships between the classes, that are, the associations, are presented briefly in the class diagrams.

In the class diagrams, similar classes are combined in a more general class by generalization, identifying common elements of entities. Therefore, a superclass (a parent) has the most general attributes (−), operations (+), and relationships that can be shared with/inherits to subclasses (children). Hence, a subclass may have more specialized attributes and operations. Different types of relationships between the actors are present. Aggregation (◊) implies a relationship where a subclass can exist independently of the superclass. Composition (◆) implies a relationship where a subclass cannot exist independent of the superclass [105].

By examining Figure 6, the study case of the microgrid phase of the Sundom smart grid, the following can be concluded. The consumer, load, PV unit, BESS, and inverter superclass have several subclasses. The MMS consists of MEMS, PMS, tertiary controller(s), and secondary controller(s), and it is aggregated with the DMS and SCADA.



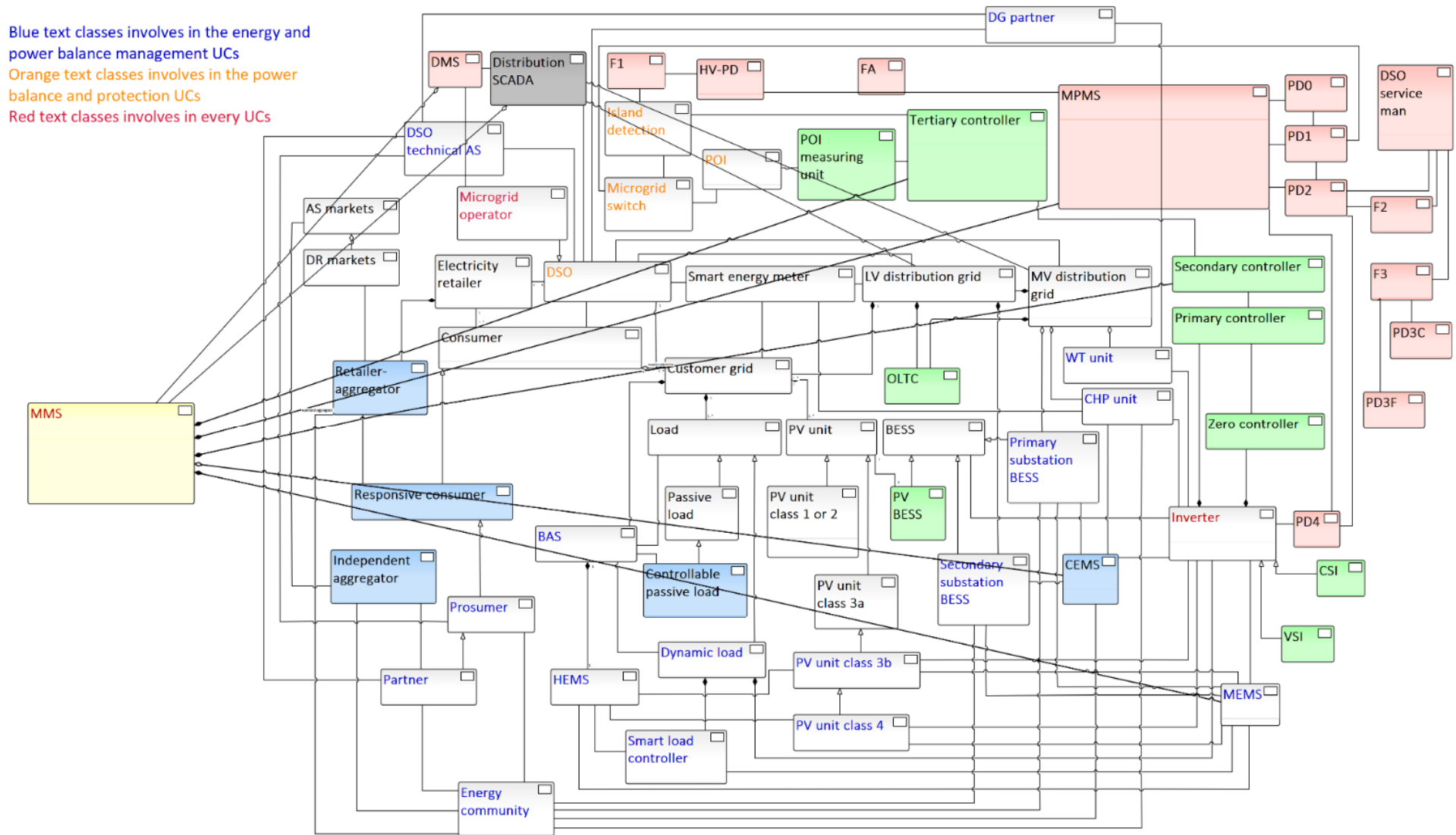

Figure 6. Class diagram of the suburban distribution network management of the microgrid phase.

**Table 8.** Classified actors of the evolving electricity distribution networks.

	Traditional	Self-Sufficient	Microgrid	Intelligent Microgrid Network	
ENERGY MANAGEMENT	<p><u>Person roles:</u> consumer</p> <p><u>Equipment:</u> PV unit class 1, 2, and 3a, controllable passive loads</p>	<p><u>Person roles:</u> responsive consumer, prosumer, energy community</p> <p><u>Equipment:</u> PV unit class 3b and 4, inverter</p> <p><u>Systems:</u> BAS, HEMS</p>	<p><u>Person roles:</u> partner</p> <p><u>Equipment:</u> dynamic load, smart load controller</p>	<p><u>person roles:</u> strategic partner</p>	Customer (C)
	<p><u>Person roles:</u> DSO</p> <p><u>Equipment:</u> WT unit</p>	<p><u>Equipment:</u> SS-BESS, PS-BESS, CHP unit, inverter</p> <p><u>Systems:</u> CEMS</p>	<p><u>Person roles:</u> microgrid operator</p> <p><u>Systems:</u> MMS, MEMS</p>	<p><u>systems:</u> CMMS</p>	Distribution (D)
	<p><u>Systems:</u> DSOs SCADA, DMS, and MDMS</p>	<p><u>Systems:</u> DSOs AS system</p>			Operation (O)
		<p><u>Person roles:</u> retailer-aggregator, DG partner</p>	<p><u>Person roles:</u> independent aggregator</p>		Service Provider (SP)
	<p><u>Person roles:</u> electricity retailer</p> <p><u>Systems:</u> DR markets</p>	<p><u>Systems:</u> DR markets (Elspot, Elbas, FCR-N, FCR-D)</p>	<p><u>Systems:</u> AS markets, DR markets (FFR)</p>		Markets (M)
POWER BALANCE MANAGEMENT			<p><u>Person roles:</u> responsive consumer, prosumer, partner, the energy community</p> <p><u>Equipment:</u> controllable passive load, dynamic load, and smart load controller, PV unit class 3b and class 4, PV-BESS</p> <p><u>Systems:</u> BAS, HEMS, primary controller of the DER</p>		C
			<p><u>Person roles:</u> microgrid operator</p> <p><u>Equipment:</u> CHP unit, WT unit, microgrid switch, OLTC, PS-BESS, LV-OLTC, SS-BESS</p> <p><u>Systems:</u> MEMS, primary controller, secondary controller, tertiary controller</p>		D
			<p><u>Systems:</u> DSO's TAS</p>		O
			<p><u>Person roles:</u> independent aggregator</p>		S
			<p><u>Systems:</u> AS market systems</p>		M

Table 8. Cont.

	Traditional	Self-Sufficient	Microgrid	Intelligent Microgrid Network	
PROTECTION			Equipment: PD4, PV inverter, BESS inverter		C
			Person roles: DSO, microgrid operator, DSO service man Equipment: microgrid switch, POI measuring unit, CHP unit inverter, WT unit inverter, PS-BESS inverter, SS-BESS inverter, PD1, PD2, PD3, PD3C, PD3F Systems: DMS, MMS, MPMS, primary controller, secondary controller, tertiary controller, island detection Phenomenon: fault F1, F2, and F3		D
					O
					SP
					M

## 7. Discussion—Derivation of Class Diagrams from Use Cases

This paper uses a UML-based method to analyze the future electricity distribution network evolution, where the UCs or operational scenarios are a starting point for developing (i) a joint roadmap and (ii) a control and management system scheme for various stakeholders' use. Four network evolution phases forming a road map were recognized: the traditional, self-sufficient, microgrid, and intelligent microgrid phases. For analyzing the electricity distribution network development by their operation, various UCs were developed related to energy management, power balance management, and protection, associated with the network evolution phases, as presented in Figure 7. The HL-UCs were developed concerning the high-level functions for:

1. Energy management: electricity supply, electricity consumption, load control, electricity generation, generation control, and Volt/Var control.
2. Power balance management: regulate the output voltage and control the current of the inverter-connected DER, regulate the active and reactive power, and control power flow at the POI, and seamless switching between the operation modes.
3. OC protection: a fault in the supplying feeder (F1), fault F1 cleared, fault in the MV or LV feeder line (F2), service restoration after F2 repair, fault in the LV customer service line (F3), and service restoration after F3 repair.

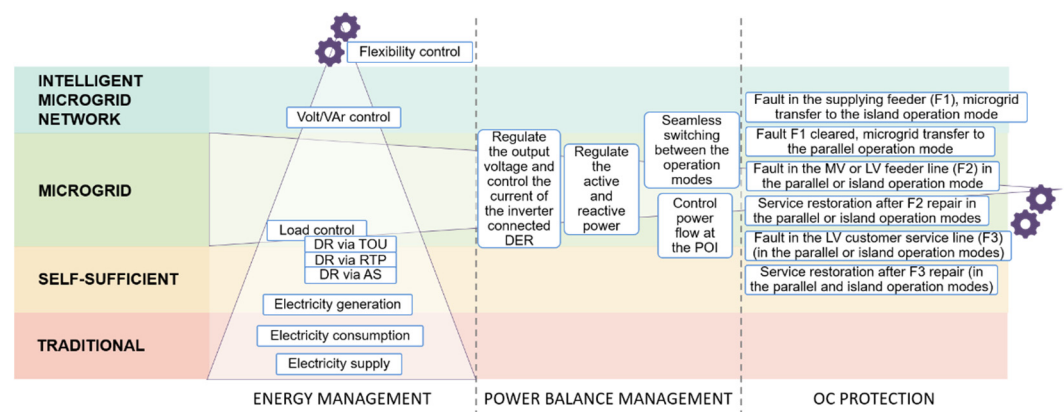

**Figure 7.** Analysis of the electricity distribution network evolution by the high-level use case studies.

The HL-UCs were developed for the energy management of the self-sufficient, microgrid, and intelligent microgrid network phases following the previous studies [13,70]. The power balance management and the OC protection HL-UCs were developed for the microgrid phase. The conceptual level (HL-UCs) and more practical level (PUCs) were developed concerning the Sundom smart grid's evolution, representing a typical network in the suburban and rural areas in the Nordic countries.

As an outcome of the UC analysis, the outline of the future network management architecture scheme was developed for the microgrid phase. In this instance, the classified actors based on the UCs formed the management system frame. Combining the class diagrams of the energy management, power balance management, and protection of the microgrid phase, a total system management architecture scheme was produced. In this circumstance, with the help of the developed class diagrams, the static structure related to the studied operational scenarios (UCs) is illustrated.

The research findings from the energy management UCs analysis are following. The load control function was studied further regarding the DR functions in DSM and voltage support functions in the Volt/Var control for the DSO's local ASs. In the self-sufficient phase, the customers' DSM is related to cost savings in electric energy. The means that load controlled via load curtailment (DR via TOU), consumption curtailment according to the energy market prices (DR via RTP), and DR functions through the aggregated customers' load control (DR via AS marketplaces). In DR via ASs, the retailer-aggregators

collect demand flexibility and shape bids for the base power (Elsport), balancing energy (Elbas), and reserve markets (FCR). In the microgrid phase, DR in DSM is exploited for the frequency support AS, such as in the self-sufficient phase and DR using generation. The retailer-aggregators and independent aggregators can offer flexibility via the enhanced PV units and the dynamic and smart loads to the FFR market in addition to previous evolution phase options. In the self-sufficient and microgrid phase, voltage support services can be provided for the DSO's (or the microgrid owner's) local ASs through the inverter-connected DER units. DR programs could also be exploited during local disturbances in the microgrid phase to avoid service interruptions by load shedding or by direct load control. This operational scenario was left to future research. In the intelligent microgrid network phase, various DR programs are used among various stakeholders: electricity utilities, markets, aggregators, and customers, and their different roles interlinked together. In this evolution phase, DR can be used regionally as a local AS, for example, in the disturbance situations' supply restoration. A single microgrid can be used for local ASs or ASs in many ways by giving the optimization target of active and reactive power or even dispatch. A single microgrid could be described as a dynamic DER. For its nature, we consider a new HL-UC function for the intelligent microgrid network phase that is the flexibility control combining responsive generation control and responsive demand control.

For analyzing the development of the electricity distribution network management structure, actors defined in the UCs operating the system were classified, whereby class diagrams of energy management, power balance management, and protection were developed. Figure 6. presents the whole system in the microgrid phase in which the class diagrams of energy management, power balance management, and protection are combined. This class diagram gives a static illustration of the system that is the active management architecture scheme. It can be noticed from Figure 6 that several new actors are present compared to the previous evolution phases. The functions, which can serve in other actor's operations, could be discovered, and actors, which can be combined.

Compared to the traditional phase, the new operations or the new attributes of the energy management actors in the microgrid phase are in the customer class. Responsive customer's operation: assign loads for DR, and attribute: controllable loads volume, inherits to prosumers, partners, and strategic partners. Both the LV and the MV distribution grid classes have attributes: generation capacity and load control capacity compared to the traditional phase, which information can be used in future network control and management. The DG inverter attributes: status and type, and operations: measure current, measure voltage, and receive reference value, are aimed to serve the energy, power balance, and protection management. Various inverter types can be classified differently depending on the system's operational scenario and technology. Therefore, in this study, just the general inverter class is used. The diagram also illustrates that the measuring unit at the POI could be integrated, or it could be a module of the microgrid switch or the PD. Most importantly, the diagram shows the essential modules required for an MMS to be integrated or distributed with the outlined communications (association lines). For example, the CEMS can be integrated into the MEMS and further to the MMS.

A similar analysis performed by more detailed UCs, functional and structural analysis could indicate the operations that could be combined or integrated and into the decentralized autonomous operations. For further behavioral analysis, the operations in the system can be described by the activity diagrams (kind of extended flowcharts), the sequence diagrams (interaction between the objects from the classified actors), and the state diagrams (representing the system states) of the dynamics in the system. Such analysis would result in new designs of the management system for the studied scenarios, a mix of centralized and decentralized management systems.

## 8. Conclusions

With the help of the generated pathway's operational and structural description, an overview of the evolving electricity distribution networks is obtained (in the suburban or

rural areas, at least). Furthermore, with the pathway's help, the UCs, the management scheme(s), and the potential RDI topics can be indicated for understanding the critical and missing elements and the potential business cases. Doubtless, the analysis method used in this research applies to various levels of UCs, which could be used from defining a problem from the pre-studies to the piloting stage.

The presented analysis method using UML is a powerful tool for describing the main actors, system operations, and structure for developing the ADN management system. A notable feature is that by combining several class diagrams, the operations can be detected, serving other actors' operation(s), and synergies between different actors can be identified.

**Author Contributions:** Conceptualization, K.H.S.; methodology, K.H.S.; software, K.H.S.; validation, K.H.S.; formal analysis, K.H.S.; investigation, K.H.S.; resources, K.H.S.; data curation, K.H.S.; writing—original draft preparation, K.H.S.; writing—review and editing, K.H.S., K.K., H.L., and N.H.; visualization, K.H.S.; supervision, K.K. and H.L.; project administration, K.K. and H.L.; funding acquisition, K.K. and H.L. All authors have read and agreed to the published version of the manuscript.

**Funding:** This work was carried out in the SolarX research project with financial support provided by Business Finland, 2019–2021 (grant No. 6844/31/2018). This work was undertaken as part of the FLEXIMAR project (novel marketplace for energy flexibility) with financial support provided by Business Finland (grant No. 6988/31/2018) as well as Finnish companies. (<https://www.univaasa.fi/en/tutkimus/hankkeet/fleximar-novel-marketplace-energy-flexibility> (accessed on 20 March 2021)).

**Data Availability Statement:** The data that support the findings of this study are available from the corresponding author upon reasonable request.

**Conflicts of Interest:** The authors declare no conflict of interest. The funders had no role in the design of the study; in the collection, analyses, or interpretation of data; in the writing of the manuscript; or in the decision to publish the results.

Appendix A

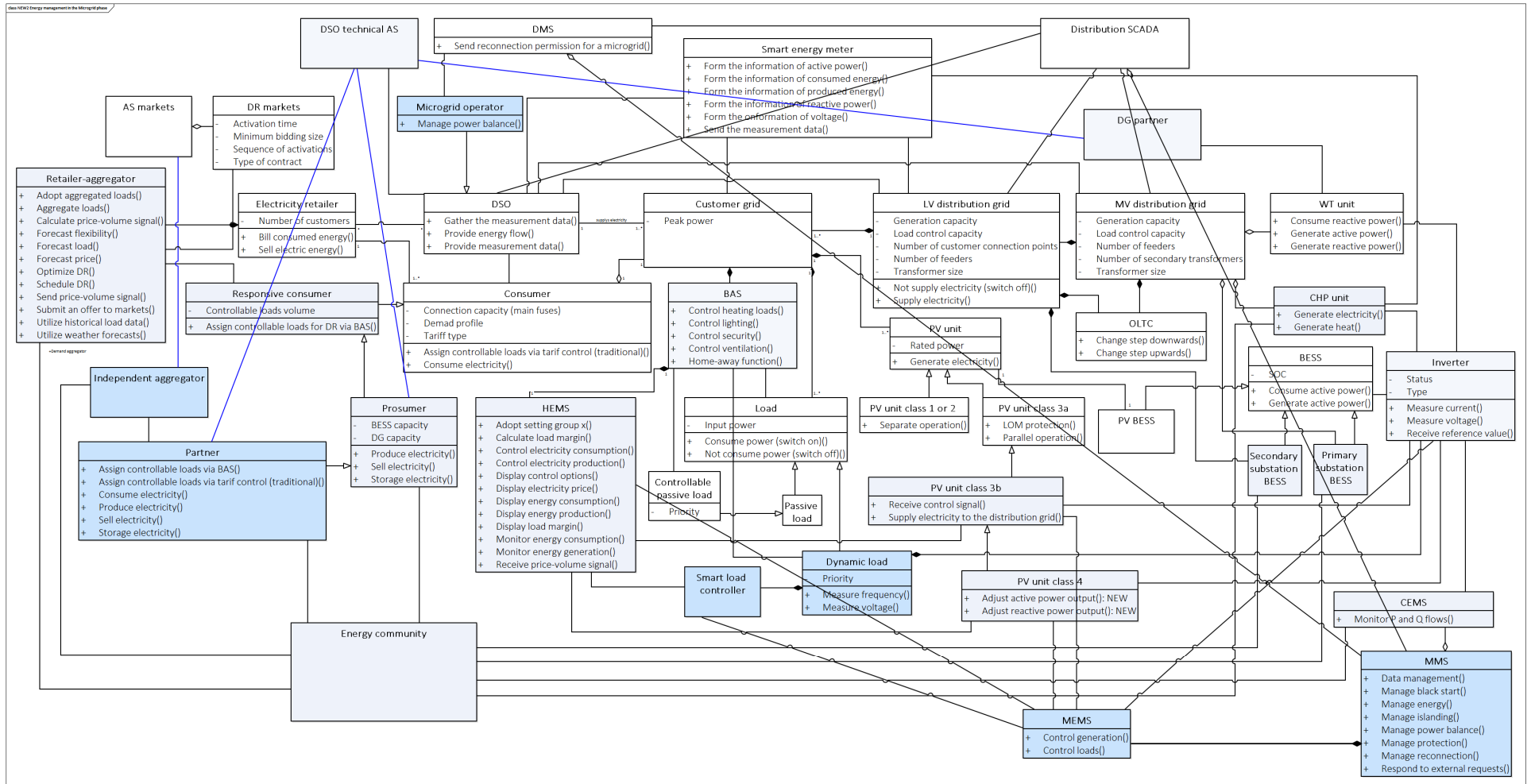

Figure A1. Class diagram of the energy management of the microgrid phase.

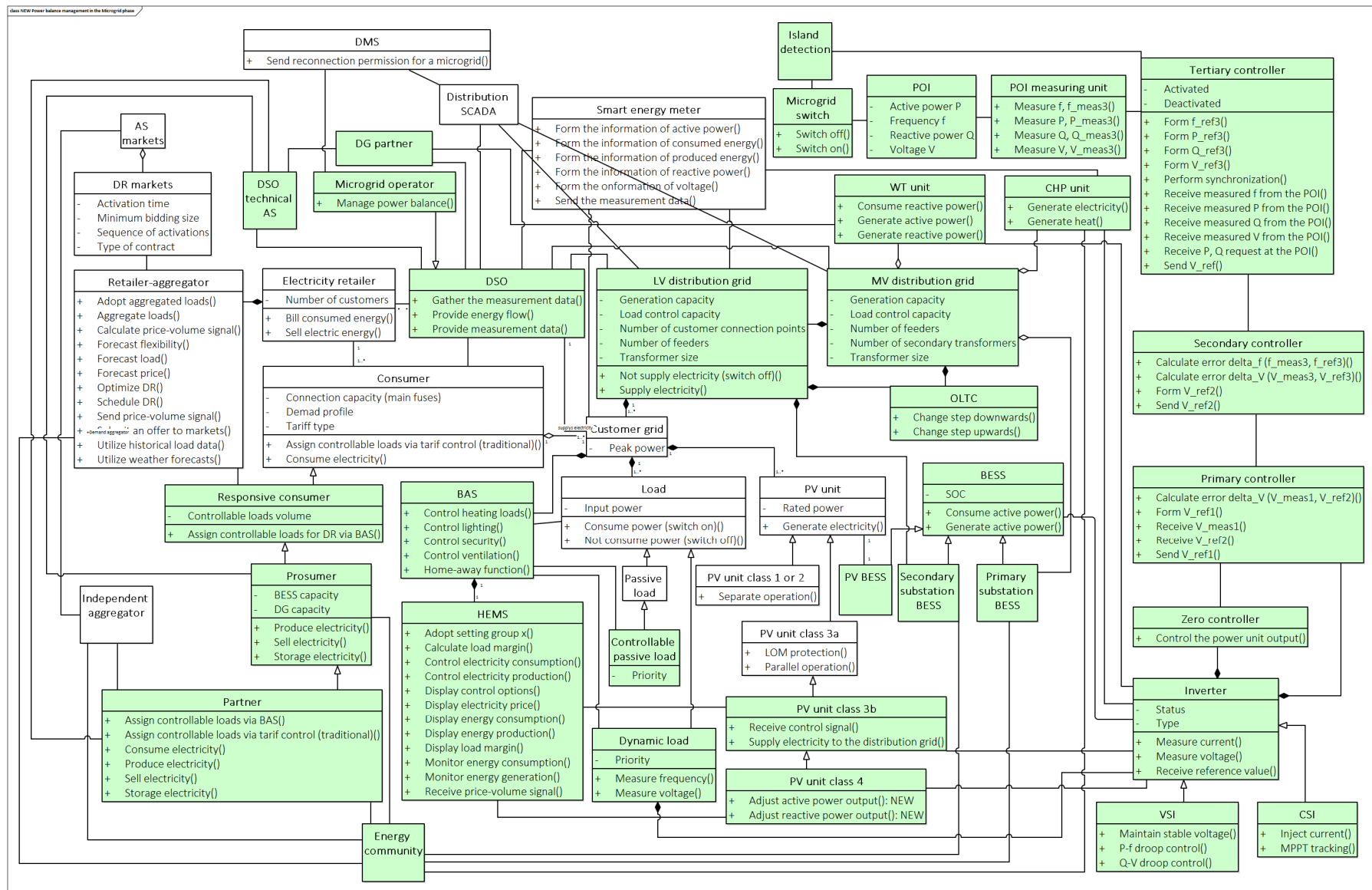

Figure A2. Class diagram of power balance management of the microgrid phase.





## References

1. European Commission. EU Climate Strategies & Targets. Available online: [https://ec.europa.eu/clima/policies/strategies\\_en](https://ec.europa.eu/clima/policies/strategies_en) (accessed on 12 February 2021).
2. European Commission. 2030 Climate Target Plan. Available online: [https://ec.europa.eu/clima/policies/eu-climate-action/2030\\_ctp\\_en](https://ec.europa.eu/clima/policies/eu-climate-action/2030_ctp_en) (accessed on 26 October 2020).
3. ETIP-SNET, Vision 2050, 2018. Available online: <https://www.etip-snet.eu/wp-content/uploads/2018/06/VISION2050-DIGITALupdated.pdf> (accessed on 26 October 2020).
4. ETIP-SNET. ETIP SNET R&I Roadmap 2020–2030. 2020. Available online: [https://www.etip-snet.eu/wp-content/uploads/2020/05/Implementation-Plan-2021-2024\\_WEB\\_Single-Page2.pdf](https://www.etip-snet.eu/wp-content/uploads/2020/05/Implementation-Plan-2021-2024_WEB_Single-Page2.pdf) (accessed on 26 October 2020).
5. Oleinikova, I.; Hillberg, E. Micro vs. MEGA: Trends Influencing the Development of the Power System, Discussion Paper, 2020. Available online: [https://www.iea-isan.org/wp-content/uploads/2020/05/ISGAN\\_DiscussionPaper\\_Annex6\\_microVsMEGA\\_2020.pdf](https://www.iea-isan.org/wp-content/uploads/2020/05/ISGAN_DiscussionPaper_Annex6_microVsMEGA_2020.pdf) (accessed on 15 February 2021).
6. Ruh, M.; Andersson, G.; Borer, A. A New Concept for a Fully Transparent Distribution Management System. In Proceedings of the 2007 IEEE Lausanne Power Tech, Lausanne, Switzerland, 1–5 July 2007; pp. 113–118. [CrossRef]
7. Antila, E.; Wiklund, G. Redefining sustainability in the electric power distribution context. In Proceedings of the International Symposium Cigre, Guilin, China, 29–31 July 2009; p. 18. Available online: [https://e-cigre.org/publication/SYMP\\_GUI\\_2009-guilin-operation-and-development-of-power-systems-in-the-new-context](https://e-cigre.org/publication/SYMP_GUI_2009-guilin-operation-and-development-of-power-systems-in-the-new-context) (accessed on 15 February 2021).
8. Hiltunen, E. *Tulossa Huomenna—Miten Megatrendit Muokkaavat Tulevaisuuttamme*; Docendo: Jyväskylä, Finland, 2019; p. 419.
9. Hiltunen, E. Weak Signals in Organizational Futures Learning Weak Signals in Organizational Futures Learning. Ph.D. Thesis, Helsinki School of Economics, Helsinki, Finland, 2010.
10. Dufvas, M. What is a Weak Signal? Sitra Articles, 2019. Available online: <https://www.sitra.fi/en/articles/what-is-a-weak-signal/> (accessed on 16 February 2021).
11. Griol-barres, I.; Milla, S.; Cebri, A.; Fan, H.; Millet, J. Detecting Weak Signals of the Future: A System Implementation Based on Text Mining and Natural Language Processing. *Sustainability* **2020**, *12*, 7848. [CrossRef]
12. CEN-CENELEC-ETSI Smart Grid Coordination Group—Sustainable Processes. SG-CG/M490/E—Part E: Smart Grid Use Case Management Process, 2012. Available online: [https://ec.europa.eu/energy/sites/ener/files/documents/xpert\\_group1\\_sustainable\\_processes.pdf](https://ec.europa.eu/energy/sites/ener/files/documents/xpert_group1_sustainable_processes.pdf) (accessed on 15 February 2021).
13. Sirviö, K.; Kauhaniemi, K.; Antila, E. Evolution phases for low voltage distribution network management. In Proceedings of the 2013 IEEE Grenoble Power Tech Conference, Grenoble, France, 16–20 June 2013; pp. 1–6. [CrossRef]
14. CEN-CENELEC-ETSI Smart Grid Coordination Group. Overview of SG-CG Methodologies, 2014. Available online: <https://www.cenelec.eu/standards/Sectorsold/SustainableEnergy/SmartGrids/Pages/default.aspx> (accessed on 15 February 2021).
15. Uslar, M.; Specht, M.; Dänekas, C.; Trefke, J.; Rohjans, S.; González, J.M.; Rosinger, C.; Bleiker, R. *Standardization in Smart Grids*; Springer: Berlin, Germany, 2013; p. 250.
16. CEN-CENELEC-ETSI Smart Grid Coordination Group. Smart Grid Reference Architecture, 2012. Available online: [https://ec.europa.eu/energy/sites/ener/files/documents/xpert\\_group1\\_reference\\_architecture.pdf](https://ec.europa.eu/energy/sites/ener/files/documents/xpert_group1_reference_architecture.pdf) (accessed on 15 February 2021).
17. Arnold, G.W.; FitzPatrick, G.J.; Wollman, D.A.; Nelson, T.L.; Boynton, P.A.; Koepke, G.H.; Hefner, A.R., Jr.; Nguyen, C.T.; Mazer, J.A.; Prochaska, D.E.; et al. *NIST Framework and Roadmap for Smart Grid Interoperability Standards, Release 2.0*; NIST: Gaithersburg, MD, USA, 2012. [CrossRef]
18. Greer, C.; Wollman, D.A.; Prochaska, D.E.; Boynton, P.A.; Mazer, J.A.; Nguyen, C.T.; FitzPatrick, G.J.; Nelson, T.L.; Koepke, G.H.; Hefner, A.R., Jr.; et al. *NIST Framework and Roadmap for Smart Grid Interoperability Standards, Release 3.0*; NIST: Gaithersburg, MD, USA, 2014. [CrossRef]
19. Pilo, F.; Jupe, S.; Silvestro, F.; Abbey, C.; Bak-Jensen, B.; Carter-Brown, C.; Celli, G.; El Bakari, K.; Fan, M.; Georgilakis, P.; et al. Planning and Optimization Methods for Active Distribution Systems Working Group C6.19, 2014. Available online: <https://e-cigre.org/publication/591-planning-and-optimization-methods-for-distribution-systems> (accessed on 15 February 2021).
20. IEEE. *IEEE Standard for the Specification of Microgrid Controllers*; IEEE: New York, NY, USA, 2018; p. 43.
21. IEC. *Microgrids—Part 1: Guidelines for Microgrid Projects Planning and Specification IEC TS 62898-1*; IEC: Geneva, Switzerland, 2017; p. 35.
22. Vasilakis, A.; Zafeiratou, I.; Lagos, D.T. The Evolution of Research in Microgrids Control. *IEEE Open Access J. Power Energy* **2020**, *7*, 331–343. [CrossRef]
23. Marnay, C.; Abbey, C.; Joos, G.; Ash, K.; Bando, S.; Braun, M.; Chatzivasileiadis, S.; Driesen, J.; Hatziargyriou, N.; Iravani, R.; et al. Microgrids 1 Engineering, Economics & Experience; In *Electra*; CIGRE: 2015. Available online: [http://www.e-cigre.org/publication/ELT\\_283\\_7-microgrids-1-engineering-economics--experience---capabilities-benefits-business-opportunities-andexamples---microgrids-evolution-roadmap](http://www.e-cigre.org/publication/ELT_283_7-microgrids-1-engineering-economics--experience---capabilities-benefits-business-opportunities-andexamples---microgrids-evolution-roadmap) (accessed on 15 February 2021).

24. Marnay, C.; Chatzivasileiadis, S.; Abbey, C.; Iravani, R.; Joos, G.; Lombardi, P.; Mancarella, P.; von Appen, J. Microgrid evolution roadmap. In Proceedings of the 2015 International Symposium on Smart Electric Distribution Systems and Technologies, EDST 2015, Vienna, Austria, 8–11 September 2015; pp. 139–144. [CrossRef]
25. Mancarella, P.; Hatziargyriou, N.D.; Tao, L.; Buchholz, B. European Roadmap for Microgrids. In Proceedings of the CIGRE 2010, Paris, France, 23–27 August 2010; pp. 1–12. Available online: [https://e-cigre.org/publication/C6-306\\_2010-european-roadmap-for-microgrids](https://e-cigre.org/publication/C6-306_2010-european-roadmap-for-microgrids) (accessed on 15 February 2021).
26. Strbac, G.; Mancarella, P.; Pudjianto, D. DH1 Microgrid Evolution Roadmap in EU—In More Microgrids Research Program, 2009. Available online: <http://www.microgrids.eu/documents/676.pdf> (accessed on 15 February 2021).
27. California ISO. Roadmap for Commercializing Microgrids in California DRAFT, 2018. Available online: [https://www.aiso.com/Documents/DraftMicrogridRoadmap\\_CEC\\_CPUC\\_ISO\\_CaliforniaMicrogridRoadmapJointWorkshop\\_Oct22017.pdf](https://www.aiso.com/Documents/DraftMicrogridRoadmap_CEC_CPUC_ISO_CaliforniaMicrogridRoadmapJointWorkshop_Oct22017.pdf) (accessed on 15 February 2021).
28. Yu, J.; Marnay, C.; Jin, M.; Yao, C.; Liu, X.; Feng, W. Review of Microgrid Development in the United States and China and Lessons Learned for China. *Energy Procedia* **2018**, *145*, 217–222. [CrossRef]
29. Xiang, Y.; Liu, J.; Li, F.; Liu, Y.; Liu, Y.; Xu, R.; Su, Y.; Ding, L. Optimal Active Distribution Network Planning: A Review. *Electr. Power Compon. Syst.* **2016**, *44*, 1075–1094. [CrossRef]
30. Zhong, Q.; Sun, W.; Yu, N.; Liu, C.; Wang, F.; Zhang, X. Load and power forecasting in active distribution network planning. *Zhongguo Dianji Gongcheng Xuebao/Proc. Chin. Soc. Electr. Eng.* **2014**, *34*, 3050–3056. [CrossRef]
31. Celli, G.; Mocci, S.; Pilo, F.; Bertini, D.; Cicoria, R.; Corti, S. Multi-Year Optimal Planning of Active Distribution Networks. In Proceedings of the 19th International Conference on Electricity Distribution CIRED 2007, Vienna, Austria, 21–24th May 2007; pp. 1–5. Available online: [https://www.researchgate.net/publication/228416211\\_Multi-year\\_Optimal\\_Planning\\_of\\_Active\\_Distribution\\_Networks](https://www.researchgate.net/publication/228416211_Multi-year_Optimal_Planning_of_Active_Distribution_Networks) (accessed on 15 February 2021).
32. Pilo, F.; Celli, G.; Mocci, S.; Soma, G.G. Multi-objective programming for optimal DG integration in active distribution systems. In Proceedings of the IEEE PES General Meeting, PES 2010, Minneapolis, MN, USA, 25–29 July 2010; pp. 1–7. [CrossRef]
33. Martins, V.F.; Borges, C.L.T. Active distribution network integrated planning incorporating distributed generation and load response uncertainties. *IEEE Trans. Power Syst.* **2011**, *26*, 1–9. [CrossRef]
34. Lin, X.; Sun, J.; Ai, S.; Xiong, X.; Wan, Y.; Yang, D. Distribution network planning integrating charging stations of electric vehicle with V2G. *Int. J. Electr. Power Energy Syst.* **2014**, *63*, 507–512. [CrossRef]
35. Al Kaabi, S.S.; Zeineldin, H.H.; Khadkikar, V. Planning active distribution networks considering multi-DG configurations. *IEEE Trans. Power Syst.* **2014**, *29*, 785–793. [CrossRef]
36. Gill, S.; Kockar, I.; Ault, G.W. Dynamic optimal power flow for active distribution networks. *IEEE Trans. Power Syst.* **2014**, *29*, 121–131. [CrossRef]
37. Gabash, A.; Li, P. Active-reactive optimal power flow in distribution networks with embedded generation and battery storage. *IEEE Trans. Power Syst.* **2012**, *27*, 2026–2035. [CrossRef]
38. Pilo, F.; Lama, R.; Valtorta, G. Planning of Power Distribution Systems. In Proceedings of the 25th International Conference on Electricity Distribution CIRED, Madrid, Spain, 3–6 June 2019; pp. 1–37. Available online: [http://www.cired2019.org/images/Special\\_report\\_S5.pdf](http://www.cired2019.org/images/Special_report_S5.pdf) (accessed on 15 February 2021).
39. Millar, R.J.; Saarijärvi, E.; Lehtonen, M.; Degefa, M.; Koivisto, M. Impact of Node Specific Load Growth and Microgrids on Distribution Network Planning. In Proceedings of the CIGRE 2014, Paris, France, 24–29 August 2014; pp. 1–5. Available online: <https://e-cigre.org/publication/SESSION2014-2014-cigre-session> (accessed on 15 February 2021).
40. Celli, G.; Ghiani, H.; Mocci, S.; Pilo, F.; Soma, G.G.; Vertuccio, C. Probabilistic Planning of Multi-Microgrids with Optimal Hybrid Multi-Generation sets. In Proceedings of the CIGRE 2016, Paris, France, 21–26 August 2014; Available online: [https://e-cigre.org/publication/C6-309\\_2016](https://e-cigre.org/publication/C6-309_2016) (accessed on 15 February 2021).
41. Quashie, M.; Bouffard, F.; Joós, G. Business cases for isolated and grid connected microgrids: Methodology and applications. *Appl. Energy* **2017**, *205*, 105–115. [CrossRef]
42. Stadler, M.; Naslé, A. Planning and implementation of bankable microgrids. *Electr. J.* **2019**, *32*, 24–29. [CrossRef]
43. Sirviö, K.; Kauhaniemi, K.; Ali Memon, A.; Laaksonen, H.; Kumpulainen, L. Functional Analysis of the Microgrid Concept Applied to Case Studies of the Sundom Smart Grid. *Energies* **2020**, *13*, 31. [CrossRef]
44. Afraz, A.; Rezaeealam, B.; SeyedShenava, S.; Doostizadeh, M. Active distribution network planning considering shared demand management. *J. Intell. Fuzzy Syst.* **2019**, *37*, 8015–8028. Available online: <https://content.iospress.com/articles/journal-of-intelligent-and-fuzzy-systems/ifs190420> (accessed on 15 February 2021). [CrossRef]
45. Mokryani, G. Active distribution networks planning with integration of demand response. *Sol. Energy* **2015**, *122*, 1362–1370. [CrossRef]
46. Laaksonen, H.; Sirviö, K.; Aflecht, S.; Hovila, P. Multi-objective active network management scheme studied in Sundom smart grid with MV and LV network connected DER units. In Proceedings of the 25th International Conference on Electricity Distribution, Madrid, Spain, 3–6 June 2019; pp. 1–5. [CrossRef]
47. Tenti, P.; Caldognetto, T. On microgrid evolution to local area energy network (E-LAN). *IEEE Trans. Smart Grid* **2016**, *10*, 1567–1576. [CrossRef]
48. Fan, J.; Borlase, S. The evolution of distribution. *IEEE Power Energy Mag.* **2009**, *7*, 63–68. [CrossRef]

49. Chuang, A.S.; Schwaegerl, C. Ancillary services for renewable integration. In Proceedings of the CIGRE/EEE PES Joint Symposium: Integration of Wide-Scale Renewable Resources into the Power Delivery System, Calgary, AB, Canada, 29–31 July 2009; pp. 1–14. Available online: <https://ieeexplore.ieee.org/document/5211165> (accessed on 15 February 2021).
50. Kraftwerke. What are Ancillary Services? Available online: <https://www.next-kraftwerke.com/knowledge/ancillary-services> (accessed on 15 February 2021).
51. Fingrid. Reserves and Balancing Power, 2019. Available online: [https://www.fingrid.fi/en/electricity-market/reserves\\_and\\_balancing/](https://www.fingrid.fi/en/electricity-market/reserves_and_balancing/) (accessed on 15 February 2021).
52. Ministry of Economic Affairs and Employment of Finland. Energy and Climate Roadmap 2050, 2014. Available online: <https://tem.fi/documents/1410877/2769658/Energy+and+Climate+Roadmap+2050/9fd1b4ca-346d-4d05-914a-2e20e5d33074> (accessed on 15 February 2021).
53. Ministry of Economic Affairs and Employment of Finland. A Flexible and Customer-driven Electricity System, Final report by the Smart Grid Working Group, Helsinki 2018. Available online: [https://julkaisut.valtioneuvosto.fi/bitstream/handle/10024/161147/TEM\\_39\\_2018.pdf?sequence=1&isAllowed=y](https://julkaisut.valtioneuvosto.fi/bitstream/handle/10024/161147/TEM_39_2018.pdf?sequence=1&isAllowed=y) (accessed on 15 February 2021).
54. Ministry of Economic Affairs and Employment of Finland. Smart Grid Working Group Final Report—Main Proposals, 2018. Available online: <https://tem.fi/documents/1410877/3481825/FI+smart+grid+WG+main+proposals+23102018.pdf/d39e6b47-70b6-aab3-b195-e04a69dd5b24/FI+smart+grid+WG+main+proposals+23102018.pdf> (accessed on 15 February 2021).
55. Kumpulainen, L.; Rinta-Luoma, J.; Voima, S.; Kauhaniemi, K.; Sirviö, K.; Koivisto-Rasmussen, R.; Valkama, A.-K.; Honkapuro, S.; Partanen, J.; Lassila, J.; et al. Roadmap 2025, 2016. Available online: [https://energia.fi/files/786/Roadmap\\_2025\\_loppuraportti.pdf](https://energia.fi/files/786/Roadmap_2025_loppuraportti.pdf) (accessed on 15 February 2021).
56. Nordic Energy Regulators. An Overview of the Nordic Electricity Market. Available online: <https://www.nordicenergyregulators.org/about-nordreg/an-overview-of-the-nordic-electricity-market/> (accessed on 15 February 2021).
57. Fingrid. Balancing Energy and Balancing Capacity Markets, 2018. Available online: [https://www.fingrid.fi/en/electricity-market/reserves\\_and\\_balancing/balancing-energy-and-balancing-capacity-markets/](https://www.fingrid.fi/en/electricity-market/reserves_and_balancing/balancing-energy-and-balancing-capacity-markets/) (accessed on 15 February 2021).
58. Fingrid. Reserve Products and Reserve Market Places, 2019. Available online: <https://www.fingrid.fi/globalassets/dokumentit/en/electricity-market/reserves/reserve-products-and-reserve-market-places.pdf> (accessed on 15 February 2021).
59. Fingrid. Terms and Conditions for Providers of Frequency Containment Reserves (FCR), 2020. Available online: [https://www.fingrid.fi/globalassets/dokumentit/en/electricity-market/reserves/reservitoimittajien-fcr-ehdot-ja-edellytykset\\_en.pdf](https://www.fingrid.fi/globalassets/dokumentit/en/electricity-market/reserves/reservitoimittajien-fcr-ehdot-ja-edellytykset_en.pdf) (accessed on 15 February 2021).
60. Fingrid. The Technical Requirements and the Prequalification Process of Frequency Containment Reserves (FCR), 2019. Available online: <https://www.fingrid.fi/globalassets/dokumentit/en/electricity-market/reserves/appendix3---technical-requirements-and-prequalification-process-of-fcr.pdf> (accessed on 15 February 2021).
61. Fingrid. Terms and Conditions for Providers of Automatic Frequency Restoration Reserves (aFRR), 2020. Available online: [https://www.fingrid.fi/globalassets/dokumentit/en/electricity-market/reserves/reservitoimittajien-afrr-ehdot-ja-edellytykset\\_en.pdf](https://www.fingrid.fi/globalassets/dokumentit/en/electricity-market/reserves/reservitoimittajien-afrr-ehdot-ja-edellytykset_en.pdf) (accessed on 15 February 2021).
62. Fingrid. The Technical Requirements and the Prequalification Process of Automatic Frequency Restoration Reserve (aFRR), 2019. Available online: [https://www.fingrid.fi/globalassets/dokumentit/en/electricity-market/reserves/automaattisen-taajuudenhallintareservin-afrr-teknisten-vaatimusten-todentaminen-ja-hyvaksyttamispr\\_en.pdf](https://www.fingrid.fi/globalassets/dokumentit/en/electricity-market/reserves/automaattisen-taajuudenhallintareservin-afrr-teknisten-vaatimusten-todentaminen-ja-hyvaksyttamispr_en.pdf) (accessed on 15 February 2021).
63. Fingrid. Technical Requirements and Prequalification Process for the Manual Frequency Restoration Reserve (mFRR), 2019. Available online: [https://www.fingrid.fi/globalassets/dokumentit/en/electricity-market/reserves/liite-2-manuaalisen-taajuuden-palautusreservin\\_en-id-237928.pdf](https://www.fingrid.fi/globalassets/dokumentit/en/electricity-market/reserves/liite-2-manuaalisen-taajuuden-palautusreservin_en-id-237928.pdf) (accessed on 15 February 2021).
64. Fingrid. Ehdot ja Edellytykset Manuaalisen Taajuuden Palautusreservin (mFRR) Itsenäiselle Toimittajalle Pilotin Aikana, 2020. Available online: <https://www.fingrid.fi/globalassets/dokumentit/fi/sahkomarkkinat/kehityshankkeet/ehdot-ja-edellytykset-manuaalisen-taajuuden-palautusreservin-mfrr-itsenaiselle-toimittajalle-pilotin-aikana.pdf> (accessed on 15 February 2021).
65. Fingrid. Fast Frequency Reserve, 2020. Available online: [https://www.fingrid.fi/en/electricity-market/reserves\\_and\\_balancing/fast-frequency-reserve/#procurement](https://www.fingrid.fi/en/electricity-market/reserves_and_balancing/fast-frequency-reserve/#procurement) (accessed on 15 February 2021).
66. Fingrid. Terms and Conditions for Providers of Fast Frequency Restoration Reserves (FRR), 2020. Available online: <https://www.fingrid.fi/globalassets/dokumentit/en/electricity-market/reserves/terms-and-conditions-for-providers-of-frr.pdf> (accessed on 15 February 2021).
67. Fingrid, Demand-side Management. Available online: <https://www.fingrid.fi/en/electricity-market/market-integration/the-future-of-the-electricity-markets/demand-side-management/> (accessed on 15 February 2021).
68. Fingrid. Taajuuden Vakautusreservien (FCR) Teknisten Vaatimusten Todentaminen ja Hyväksyttämisen prosessi, 2021. Available online: <https://www.fingrid.fi/globalassets/dokumentit/fi/sahkomarkkinat/reservit/fcr-liite2---teknisten-vaatimusten-todentaminen-ja-hyvaksyttamisprosessi.pdf> (accessed on 18 March 2021).
69. Fingrid. The Technical Requirements and the Prequalification Process of Frequency Containment Reserves (FFR), 2020. Available online: <https://www.fingrid.fi/globalassets/dokumentit/en/electricity-market/reserves/terms-and-conditions-for-providers-of-ffr.pdf> (accessed on 18 March 2021).
70. Sirviö, K.; Berg, P.; Kauhaniemi, K.; Laaksonen, H.; Laaksonen, P.; Rajala, A. Socio-technical modelling of customer roles in developing low voltage distribution networks. In Proceedings of the CIRED 2018 Workshop, Lubljana, Slovenia, 7–8 June 2018; pp. 1–4. [CrossRef]

71. Apajalahti, E.L.; Lovio, R.; Heiskanen, E. From demand side management (DSM) to energy efficiency services: A Finnish case study. *Energy Policy* **2015**, *81*, 76–85. [CrossRef]
72. CENELEC. *EN 50438 Requirements for the Connection of Micro-generators in Parallel with Public Low-voltage Distribution Networks*; CENELEC: Brussels, Belgium, 2007; pp. 1–53.
73. Energiatieteiden tutkimuskeskus. Verkostosuositus YA9:13, 2019. Available online: [https://energia.fi/files/4249/Mikrotuotannon\\_liittaminen\\_verkostosuositus\\_luonnos\\_PAIVITETTY\\_20191203\\_FINAL.pdf](https://energia.fi/files/4249/Mikrotuotannon_liittaminen_verkostosuositus_luonnos_PAIVITETTY_20191203_FINAL.pdf) (accessed on 16 February 2021).
74. Ministry of Economic Affairs and Employment of Finland. *Pienimuotoisen Energiantuotannon Edistämistyöryhmän Loppuraportti*; Edita: Helsinki, Finland, 2014; Available online: <https://vnk.fi/documents/1410877/2859687/Pienimuotoisen+energiatuotannon+edistamistyoryhman+loppuraportti+16122014.pdf> (accessed on 16 February 2021).
75. Finnish Parliament. *Sähkömarkkinalaki (Electricity Market Act) 9.8.2013/588*. Finland, 2013. Available online: <https://finlex.fi/fi/laki/alkup/2013/20130588> (accessed on 16 February 2021).
76. European Commission. *Proposal for a Directive of the European Parliament and of the Council on Common Rules for the Internal Market in Electricity (Recast)*. 2016/0380; European Commission: Brussels, Belgium, 2017; pp. 1–124. Available online: [https://eur-lex.europa.eu/resource.html?uri=cellar:c7e47f46-faa4-11e6-8a35-01aa75ed71a1.0014.02/DOC\\_1&format=PDF](https://eur-lex.europa.eu/resource.html?uri=cellar:c7e47f46-faa4-11e6-8a35-01aa75ed71a1.0014.02/DOC_1&format=PDF) (accessed on 16 February 2021).
77. Sener. *Pienvoimaloiden Liittäminen Jakeluverkkoon*; Sener: Helsinki, Finland, 2001.
78. Sirviö, K. Controller Development for Reactive Power Flow Management between DSO and TSO Networks. In Proceedings of the 2019 IEEE PES Innovative Smart Grid Technologies Europe (ISGT-Europe 2019), Bucharest, Romania, 29 September–2 October 2019; pp. 1–5. [CrossRef]
79. Sirviö, K.H.; Mekkanen, M.; Kauhaniemi, K.; Laaksonen, H.; Salo, A.; Castro, F.; Babazadeh, D. Accelerated Real-Time Simulations for Testing a Reactive Power Flow Controller in Long-Term Case Studies. *J. Electr. Comput. Eng.* **2020**, *17*. [CrossRef]
80. Albadi, M.H.; El-Saadany, E.F. Demand Response in Electricity Markets: An Overview. In Proceedings of the 2007 IEEE Power Engineering Society General Meeting, Tampa, FL, USA, 24–28 June 2007; pp. 1–5. [CrossRef]
81. Albadi, M.H.; El-Saadany, E.F. A summary of demand response in electricity markets. *Electr. Power Syst. Res.* **2008**, *78*, 1989–1996. [CrossRef]
82. Koto, A.; Lu, S.; Valavaara, T.; Rautiainen, A.; Repo, S. Aggregation of small-scale active resources for smart grid management. In Proceedings of the 2011 IEEE PES Innovative Smart Grid Technologies Conference Europe (ISGT-Europe 2011), Manchester, UK, 5–7 December 2011; pp. 1–7. [CrossRef]
83. Yang, H.T.; Liao, J.T.; Lin, C.I. A load forecasting method for HEMS applications. In Proceedings of the 2013 IEEE Grenoble PowerTech Conference, Grenoble, France, 16–20 June 2013; pp. 1–6. [CrossRef]
84. Ikäheimo, J.; Evens, C.; Kärkkäinen, S. DER Aggregator Business: The Finnish Case, 2010. Available online: <https://citeseerx.ist.psu.edu/viewdoc/download?doi=10.1.1.454.3257&rep=rep1&type=pdf> (accessed on 16 February 2021).
85. S Group. S-ryhmän Kysyntäjoustoprojekti “HertSi” Loppuraportti, 2015. Available online: <https://www.fingrid.fi/globalassets/dokumentit/fi/sahkomarkkinat/kysyntajousto/kysyntajoustoprojekti-s-ryhmassa-loppuraportti.pdf> (accessed on 16 February 2021).
86. Palola, I.; Sailo, S.; Haapasalo, A. Kysynnänjouston Pilottiprojekti, Loppuraportti, 2016. Available online: <https://www.fingrid.fi/globalassets/dokumentit/fi/sahkomarkkinat/kysyntajousto/kysynnänjouston-pilottiprojekti-loppuraportti-julkinen.pdf> (accessed on 16 February 2021).
87. Bessa, R.J.; Matos, M.A. The role of an aggregator agent for EV in the electricity market. In Proceedings of the IET Conference Publications, 7th Mediterranean Conference and Exhibition on Power Generation, Transmission, Distribution and Energy Conversion (MedPower 2010), Agia Napa, Cyprus, 7–10 November 2010; pp. 1–9. [CrossRef]
88. Houwing, M.; Negenborn, R.R.; De Schutter, B. Demand Response with Micro-CHP Systems. *Proc. IEEE* **2011**, *99*, 200–213. [CrossRef]
89. Council of the European Union, European Parliament. *European Parliament, Directive 2019/944 (EU) on Common Rules for the Internal Market for Electricity and Amending Directive 2012/27/EU*; Official Journal of the European Union: Brussels, Belgium, 2019; p. 75.
90. Short, J.A.; Infield, D.G.; Freris, L.L. Stabilization of grid frequency through dynamic demand control. *IEEE Trans. Power Syst.* **2007**, *22*, 1284–1293. [CrossRef]
91. ETIP-SNET. Sector Coupling: Concepts, State-of-the-Art and Perspectives, 2020. Available online: [https://www.etip-snet.eu/etip\\_publications/sector-coupling-concepts-state-art-perspectives/](https://www.etip-snet.eu/etip_publications/sector-coupling-concepts-state-art-perspectives/) (accessed on 16 February 2021).
92. Schwaegerl, C.; Tao, L.; Peças Lopes, J.; Madureira, A.; Mancarella, P.; Anastasiadis, A.; Hatziargyriou, N.; Krkoleva, A. DG3&DG4 Report on the Technical, Social, Economic, and Environmental Benefits Provided by Microgrids on Power System Operation in Advanced Architectures and Control Concepts for More Microgrids Research Program, 2009. Available online: [www.microgrids.eu/documents/668.pdf](http://www.microgrids.eu/documents/668.pdf) (accessed on 15 March 2021).
93. STT. Tulevaisuuden Lämpöenergiavarasto Otettiin Käyttöön Vaasassa. 29 September 2020. Available online: <https://www.sttinfo.fi/tiedote/tulevaisuuden-lampoenergiavarasto-otettiin-kayttoon-vaasassa?publisherId=58661976&releaseId=69889641> (accessed on 16 February 2021).
94. Palizban, O.; Kauhaniemi, K. Microgrid control principles in island mode operation. In Proceedings of the 2013 IEEE Grenoble PowerTech Conference, Grenoble, France, 16–20 June 2013; pp. 1–6. [CrossRef]

95. Chuang, A.; McGranaghan, M. Functions of a local controller to coordinate distributed resources in a smart grid. In Proceedings of the IEEE Power and Energy Society 2008 General Meeting: Conversion and Delivery of Electrical Energy in the 21st Century, PES, Pittsburgh, PA, USA, 20–24 July 2008; pp. 1–6. [[CrossRef](#)]
96. Laaksonen, H. Technical Solutions for Low-Voltage Microgrid Concept. Ph.D. Thesis, University of Vaasa, Vaasa, Finland, 2011.
97. Oates, C.; Barlow, A.; Levi, V. Tap Changer for Distributed Power. In Proceedings of the European Conference on Power Electronics and Applications, Aalborg, Denmark, 2–5 September 2007; pp. 1–9. [[CrossRef](#)]
98. Awad, B.; Shafiu, A.; Jenkins, N. Voltage control in microgrids. *Int. J. Distrib. Energy Resour.* **2008**, *4*, 7138.
99. Guerrero, J.M.; Chandorkar, M.; Lee, T.L.; Loh, P.C. Advanced control architectures for intelligent microgrids—Part I: Decentralized and hierarchical control. *IEEE Trans. Ind. Electron.* **2013**, *60*, 1254–1262. [[CrossRef](#)]
100. Guerrero, J.M.; Vasquez, J.C.; Matas, J.; De Vicuña, L.G.; Castilla, M. Hierarchical control of droop-controlled AC and DC microgrids—A general approach toward standardization. *IEEE Trans. Ind. Electron.* **2011**, *58*, 158–172. [[CrossRef](#)]
101. Bidram, A.; Davoudi, A. Hierarchical structure of microgrids control system. *IEEE Trans. Smart Grid* **2012**, *3*, 1963–1976. [[CrossRef](#)]
102. Bastidas-Rodríguez, J.D.; Ramos-Paja, C.A.; David Bastidas-Rodríguez, J.; Ramos-Paja, C. Types of inverters and topologies for microgrid applications. *UIS Ing.* **2017**, *16*, 7–14. [[CrossRef](#)]
103. Laaksonen, H. Protection scheme for Island operated medium-voltage microgrid. *Int. Rev. Electr. Eng.* **2015**, *10*, 510–519. [[CrossRef](#)]
104. Laaksonen, H.; Hovila, P. Enhanced MV microgrid protection scheme for detecting high-impedance faults. In Proceedings of the 2017 IEEE Manchester PowerTech Conference, Manchester, UK, 18–22 June 2017. [[CrossRef](#)]
105. Scott, K. *Fast Track UML 2.0*; Apress: Berkeley, CA, USA, 2004; p. 192.