

## Article

# Design and Implementation of Spring Cable Shaping Method Based on Fuzzy Control

Runxian Yang<sup>1,2,\*</sup>, Jie Zhou<sup>1</sup>, Tao Tao<sup>1,3</sup>, Lianghao Hua<sup>1,4</sup> and Jianfeng Zhang<sup>4</sup> 

<sup>1</sup> College of Intelligent Manufacturing, Yangzhou Polytechnic Institute, Yangzhou 225127, China; thisiszhoujie@163.com (J.Z.); taot@ypi.edu.cn (T.T.); dx120190079@yzu.edu.cn (L.H.)

<sup>2</sup> College of Automation Engineering, Nanjing University of Aeronautics & Astronautics, Nanjing 211106, China

<sup>3</sup> School of Agricultural Engineering, Jiangsu University, Zhenjiang 212000, China

<sup>4</sup> School of Mechanical Engineering, Yangzhou University, Yangzhou 225009, China; zhangjf@yzu.edu.cn

\* Correspondence: yangrx@ypi.edu.cn

**Abstract:** In order to improve the production efficiency and elastic quality of spring cable, and meet the market demand of automatic mass production, based on the market research and experimental analysis of common spring cable shaping methods, a rapid shaping method of coil bar current heating spring cable is innovatively proposed. After the spring cable is wound on the coil bar once, the coil bar is directly heated to realize the spring wire temperature rising and setting. The process temperature is input from the man-machine interface, and the temperature control is based on a fuzzy algorithm, which is automatically adjusted by PLC. The experimental results show that, compared with the traditional sizing method, the current heating method proposed in this paper can greatly shorten the product sizing time and has good sizing effect, which can well meet the market requirement of high-quality mass production of spring cable.

**Keywords:** spring cable; shaping; fuzzy control; current heating



**Citation:** Yang, R.; Zhou, J.; Tao, T.; Hua, L.; Zhang, J. Design and Implementation of Spring Cable Shaping Method Based on Fuzzy Control. *Appl. Sci.* **2022**, *12*, 245. <https://doi.org/10.3390/app12010245>

Academic Editor: Xiaodong Sun

Received: 11 November 2021

Accepted: 23 December 2021

Published: 27 December 2021

**Publisher's Note:** MDPI stays neutral with regard to jurisdictional claims in published maps and institutional affiliations.



**Copyright:** © 2021 by the authors. Licensee MDPI, Basel, Switzerland. This article is an open access article distributed under the terms and conditions of the Creative Commons Attribution (CC BY) license (<https://creativecommons.org/licenses/by/4.0/>).

## 1. Introduction

Spring cable, also known as slingshot wire, spiral wire, telescopic wire or spring wire, is a kind of equipment connecting wire that works by using scalability. It is generally made of TPU cable, PVC cable, Pu electric winding, etc. It is used to control the connection of power supply or signal of mobile equipment movement, which can rebound rapidly in a short time. It is widely used in mobile devices such as automobiles, CNC machine tools, industrial robots, instruments, etc. in moving equipment [1].

Due to the limitation of production technology, there is still a blank of equipment based on automatic spring cable production in China, and the difficulty of spring cable finalization is the main factor restricting the development of automatic production line. With the rapid development of the national high-end equipment manufacturing industry, on the one hand, the market demand for spring cable is rapidly increasing, but on the other hand, affected by the low efficiency of manual or semi-automatic winding and finalization of spring cable, the quality is difficult to guarantee, which greatly hinders the increase in the output and quality of spring cable. Therefore, it is particularly important to explore an efficient and fast spring cable shaping method, which can promote the R & D and market application of spring cable automatic production line to a large extent.

## 2. Common Shaping Methods of Spring Cable

The general production process of the spring cable mainly includes primary winding, heating, cooling and secondary winding. Heating and cooling are the important parts of spring cable shaping, which directly determine the quality of spring cable. At present, baking line method and water bath method are widely used at home and abroad.

### 2.1. Baking Method

Wire baking method is the most common heating method of the spring cable at present, that is, after one-time winding, the cable and the winding bar are put in the oven for heating and curing. In order to improve production efficiency, a large-scale oven is generally used, and several winding bars are placed in the oven at the same time. The top of the oven is heated by electric heating wire, and a circulating fan is built in to balance the temperature and atmosphere in the oven [2]. In the baking process, the setting process should be determined according to the material of the wire. The general temperature range is  $110 \pm 10 \text{ }^\circ\text{C}$ ~ $130 \pm 10 \text{ }^\circ\text{C}$ , and the heating time range is  $20 \pm 5 \text{ min}$ ~ $30 \pm 5 \text{ min}$ .

### 2.2. Water Bath Method

Different from the wire baking method, the water bath method, regardless of the material of the coating, is to place the cable and the winding rod after 1-time winding in  $100 \text{ }^\circ\text{C}$  hot water. Since the liquid has better thermal conductivity than air, the heating time will be greatly shortened compared with the wire baking method [3]. As the highest water temperature can only reach  $100 \text{ }^\circ\text{C}$ , the elasticity of the cable shaped by the water bath method is slightly worse than that of the wire baking method, which is generally suitable for mobile devices with low requirements for the elasticity of the cable. In addition, in order to prevent the internal copper wire from rusting, the two ends of the cable need to be waterproof before the cable is shaped by the water bath method.

## 3. Finalization Scheme Design

### 3.1. Experimental Study on Demonstration of Common Schemes

In the two commonly used shaping methods of spring cable, the heating time of baking method is long, while the water bath method is limited by  $100 \text{ }^\circ\text{C}$  temperature and requires waterproof treatment, which cannot meet the market demand of high-quality spring cable automatic mass production. In order to find a better shaping method of spring cable, the demonstration experiment was carried out based on the shaping time and heating medium of spring cable, as shown in Table 1.

**Table 1.** Experimental data of common sizing methods for spring cable.

Water Bath Method					
Related Parameters	Heating Medium Temperature ( $^\circ\text{C}$ )	Cable Internal Temperature ( $^\circ\text{C}$ )	Heating Time (s)	Cooling Setting Time (s)	
PVC	100	98.8	178	60	
PU	100	99.5	182	60	
TPE	100	99.2	175	60	
Baking Method					
Related Parameters	Heating Medium Temperature ( $^\circ\text{C}$ )	Cable Internal Temperature ( $^\circ\text{C}$ )	Heating Time (s)	Cooling Setting Time (s)	Coking Phenomenon
PVC	200	100	345	62	Y
PU	160	100	358	58	F
TPE	120	100	365	60	F

Through repeated experiments, the research conclusions are found that:

- (1) At room temperature of  $10 \text{ }^\circ\text{C}$ , put cables of different materials in  $100 \text{ }^\circ\text{C}$  hot water, insert K-type thermocouple into the cable, the internal temperature of the cable can rise to  $99 \text{ }^\circ\text{C}$  in about 3 min, and water cooling for 1 min can complete the reliable setting of spring cable;
- (2) At the room temperature of  $10 \text{ }^\circ\text{C}$ , put different materials of cable in the oven, set different oven temperature ( $100$ ~ $200 \text{ }^\circ\text{C}$ ), the internal temperature of cable can rise to

100 °C in about 6 min, and water cooling for 1 min can set. However, when the oven temperature exceeds 180 °C, PVC, PU and TPE all have coking phenomenon, among which PVC coking is the most serious.

The experimental results further show that the thermal conductivity of air is poorer and the heat transfer is slower compared with that of liquid; the internal temperature of the cable needs to rise to above 100 °C to get better shaping effect; the higher the temperature of heating medium is, the faster the temperature inside the cable rises, and the shorter the heating time is when the temperature reaches 100 °C. However, when the heating temperature exceeds 180 °C, no matter what kind of material, the spring cable will appear coking phenomenon; The lower the temperature of heating medium is, the slower the temperature inside the cable rises, and the longer the heating time is needed to reach 100 °C. Although the cables with different media will not be coking, the shaping effect is not ideal; no matter what kind of shaping method, when the heating medium is lower than 100 °C, the cable cannot be shaped.

### 3.2. Current Heating Scheme Design

In order to reduce the setting time of spring cable, improve the setting quality of spring cable and facilitate the automatic mass production of spring cable, this paper, based on the experimental research conclusions in Section 3.1, innovatively proposes a rapid shaping method of coil bar current heating spring cable as shown in Figure 1.

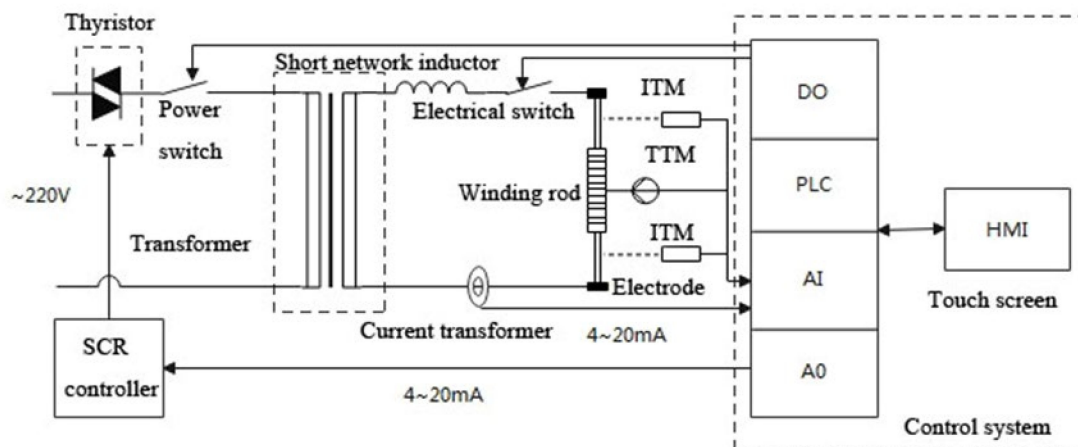

Figure 1. The structure of a current heating shaping method.

The current heating shaping method of the spring cable winding bar is to set the heating electrode medium inside the stainless-steel winding bar. When the spring cable is wound once, the constant power transformer is used to control the primary side thyristor conduction angle of the transformer through PLC and control the secondary side current of the transformer to realize the electric heating control of the winding bar [4]. The temperature of the heating medium inside the winding bar and the internal temperature of the spring cable are measured and transmitted by the thermocouple sensor and the infrared temperature sensor in real time respectively to the PLC control system. The heating temperature of the winding bar is set flexibly according to the application requirements based on the touch screen human-machine interface.

## 4. Realization of Current Heating Shaping Control

### 4.1. Design of Temperature Detection Scheme

In order to improve the measurement accuracy of the heating medium temperature inside the winding rod and the internal temperature of the spring cable, two kinds of temperature sensors are used. Due to the current flowing through the winding bar, the non-contact infrared sensor is used in the design, while the surface of the spring cable is

insulated, and the thermocouple is used to contact its surface for measurement. At the same time, considering the different sizes and models of the winding bar (different mobile devices have different requirements for the connection of moving power or signal to the spring cable), the thermocouple retains a certain degree of elastic freedom during installation, in order to adapt to the change in winding bar size. The temperature measurement scheme is shown in Figure 2.

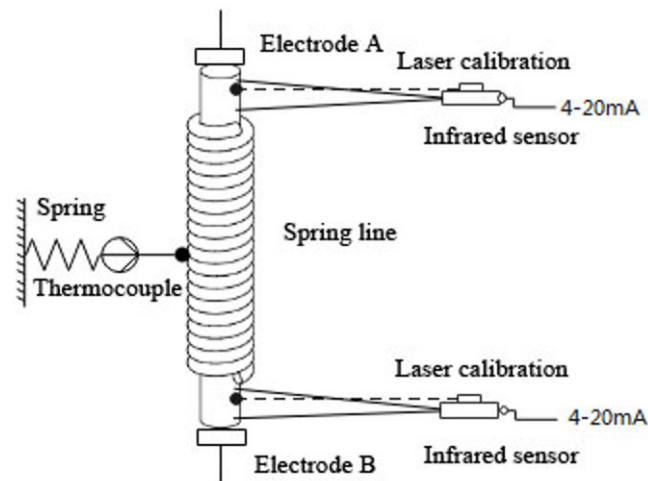

Figure 2. Temperature detection scheme.

In Figure 2, the installation distance of the infrared sensor is as close as possible to the winding bar to ensure that the cable is not within the measurement view field of the infrared sensor, so that the infrared sensor can assist the laser calibration device to accurately align with the measurement target [5]. In order to ensure the stability and accuracy of the temperature measurement of the winding bar, a pair of sensors of the same type are used in this design to form a redundant structure. If the maximum measurement error of the sensor is set to  $\Delta T$  °C, the temperature measured by the two infrared sensors at a certain time is  $T_1$  °C and  $T_2$  °C, respectively, then the temperature value collected by PLC is calculated as follows:

$$T = \begin{cases} \frac{T_1 + T_2}{2}, & |T_1 - T_2| \leq 2\Delta T \\ 0, & |T_1 - T_2| > 2\Delta T \end{cases} \quad (1)$$

If in the winding bar current heating shaping system as shown in Figure 1, when the controller PLC continuously collects  $T = 0$  within a period of time, it indicates that one of the infrared sensors is faulty, and the touch screen human-machine interface will pop up the alarm information.

#### 4.2. Realization of Temperature Control Algorithm for Spring Cable Shaping Based on Fuzzy Theory

According to the different applications, there are many kinds of inner diameters of spring cables, and the diameter of winding rod depends on the inner diameter of the spring cable. Therefore, in the actual production process, the load is constantly changing, and the accurate mathematical model of spring cable temperature control cannot be established.

In the field of intelligent control, fuzzy control is an efficient control method which does not depend on the model of the control object and is suitable for the situation, where the controlled quantity changes rapidly [6]. Based on the fuzzy control theory, this paper designs a fuzzy controller with spring cable temperature deviation  $e_1$  and winding rod temperature deviation  $e_2$  as inputs, and PLC control signal  $I$  as output to improve the accuracy of spring cable temperature, and obtain a better shaping effect in a short period of time.

#### 4.2.1. Parameter Fuzzy Distribution

In order to make the temperature of the spring cable quickly reach the set process temperature, it is necessary to raise the temperature of the winding bar as high as possible. However, if the temperature of the winding bar is too high, exceeding 180 °C, the outer material of the cable begins coking. In order to achieve a better shaping effect and ensure the quality of the outer coating of the cable, in the temperature control, the upper limit threshold of the heating temperature of the winding bar is set at 160 °C, and the domain range of the temperature deviation  $e_2$  of the winding bar is from 0 °C to 160 °C; according to the empirical data of wire baking method  $110 \pm 10 \text{ °C} \sim 130 \pm 10 \text{ °C}$ , the upper limit of heating temperature of spring cable is 140 °C, and the range of deviation  $e_1$  is from 0 °C to 140 °C; in temperature control, the scope of PLC control signal  $I$  is from 4 mA to 20 mA.

American cybernetics expert L.A. Zadeh put forward the concept of fuzzy sets and extended the fuzzy sets to interval from 0 to 1. Membership function is the key concept of representing fuzzy sets from [7] to [8]. Generally, the methods of representing fuzzy sets with membership function include triangular function, bell function, Gaussian function, trapezoidal function and Sigmoid function from [9] to [10]. In order to reflect the linear relationship among temperature deviation  $e_1$ ,  $e_2$  and control current  $I$ , and to facilitate programming, the membership function selects triangular function.

Dividing the fuzzy sets into multiple subsets with coupling relationships can effectively improve the control effect. In theory, the more the number of fuzzy subsets, the higher the control accuracy. Considering the fast heating speed of current heating and the timeliness of control, the output is divided into six states:  $Z$ (zero),  $VS$ (very small),  $S$ (small),  $M$ (medium),  $B$ (big) and  $VB$ (very big or full load output). Therefore, six fuzzy subsets  $Z$ ,  $VS$ ,  $S$ ,  $M$ ,  $B$  and  $VB$  are defined to represent zero, very small, small, medium, big and very big, respectively, covering all fuzzy domains [11]. For the convenience of programming, trigonometric function is selected as membership function [12]. If interval from  $x_0$  to  $x_1$  is used to represent the range of a parameter  $x$ , and  $a, b, c$  are used to represent the segmentation points of membership function, and  $x_0 < a < b < c < x_1$  is satisfied, then membership function is expressed as follows:

$$\begin{aligned}
 Z(x) &= 0, \quad x = x_0 \\
 S(x) &= a - x/a - x_0, \quad x_0 < x \leq a \\
 S(x) &= \begin{cases} x/a, & x_0 < x \leq a \\ b - x/b - a, & a < x \leq b \end{cases} \\
 M(x) &= \begin{cases} x - a/b - a, & a \leq x \leq b \\ c - x/c - b, & b < x \leq c \end{cases} \\
 B(x) &= \begin{cases} x - b/c - b, & b \leq x \leq c \\ x_1 - x/x_1 - c, & c < x \leq x_1 \end{cases} \\
 VB(x) &= x - c/x_1 - c, \quad c \leq x \leq x_1
 \end{aligned} \tag{2}$$

The specific shape of the each parameter membership function is determined by the segment points  $a, b$  and  $c$  on the interval from  $x_0$  to  $x_1$ . The fuzzy distribution design of each parameter range is set as, the range of  $e_1$  is select from 0 °C, 20 °C, 60 °C, 90 °C to 140 °C, the range of  $e_2$  is select from 0 °C, 40 °C, 80 °C, 110 °C to 160 °C, and the range of  $I$  is select from 4 mA, 5 mA, 8 mA, 12 mA to 20 mA.

#### 4.2.2. Establishment of Fuzzy Rules

In order to achieve better results, the following fuzzy rules are designed:

- (1) At the beginning of heating, in order to make the spring cable temperature rise rapidly, the winding rod passes through a large current to make the temperature of the winding rod and the spring cable rise rapidly;

- (2) In order to ensure that the external material of spring cable is not coking, the temperature of winding rod should be limited in a certain range;
- (3) When the temperature of the spring cable approaches the process temperature, the current of the winding bar is gradually reduced;
- (4) Since the temperature of the heating rod is higher than that of the spring wire, when the temperature of the spring wire reaches the process temperature, the heating current should be cut off immediately to prevent the temperature from rising.

According to the fuzzy rules [13,14], 36 fuzzy rules are established for current heating shaping temperature control, as shown in Table 2.

**Table 2.** Parameter fuzzy rules.

<i>I</i>	<i>e</i> <sub>1</sub>						
	<i>VB</i>	<i>B</i>	<i>M</i>	<i>S</i>	<i>VS</i>	<i>Z</i>	
<i>e</i> <sub>2</sub>	<i>VB</i>	<i>VB</i> <sub>(1)</sub>	<i>VB</i> <sub>(7)</sub>	<i>VB</i> <sub>(13)</sub>	<i>B</i> <sub>(19)</sub>	<i>M</i> <sub>(25)</sub>	<i>Z</i> <sub>(31)</sub>
	<i>B</i>	<i>VB</i> <sub>(2)</sub>	<i>VB</i> <sub>(8)</sub>	<i>B</i> <sub>(14)</sub>	<i>B</i> <sub>(20)</sub>	<i>M</i> <sub>(26)</sub>	<i>Z</i> <sub>(32)</sub>
	<i>M</i>	<i>VB</i> <sub>(3)</sub>	<i>VB</i> <sub>(9)</sub>	<i>B</i> <sub>(15)</sub>	<i>B</i> <sub>(21)</sub>	<i>M</i> <sub>(27)</sub>	<i>Z</i> <sub>(33)</sub>
	<i>S</i>	<i>B</i> <sub>(4)</sub>	<i>B</i> <sub>(10)</sub>	<i>B</i> <sub>(16)</sub>	<i>M</i> <sub>(22)</sub>	<i>S</i> <sub>(28)</sub>	<i>Z</i> <sub>(34)</sub>
	<i>VS</i>	<i>B</i> <sub>(5)</sub>	<i>B</i> <sub>(11)</sub>	<i>M</i> <sub>(17)</sub>	<i>VS</i> <sub>(23)</sub>	<i>VS</i> <sub>(29)</sub>	<i>Z</i> <sub>(35)</sub>
	<i>Z</i>	<i>VS</i> <sub>(6)</sub>	<i>VS</i> <sub>(12)</sub>	<i>VS</i> <sub>(18)</sub>	<i>Z</i> <sub>(24)</sub>	<i>Z</i> <sub>(30)</sub>	<i>Z</i> <sub>(36)</sub>

#### 4.2.3. Output Clarity

Table 2 lists 36 fuzzy relations among PLC output control current *I* and spring cable temperature deviation *e*<sub>1</sub> and winding rod temperature deviation *e*<sub>2</sub>. However, it is not necessary to activate all fuzzy relations when calculating actual current *I*. let *e*<sub>1</sub> = 80 °C and *e*<sub>2</sub> = 140 °C at a certain time. According to the fuzzy distribution of parameters, *e*<sub>1</sub> belongs to between 60 °C and 90 °C, *e*<sub>2</sub> belongs to be between 110 °C and 160 °C. According to formula (2), *e*<sub>1</sub> = 80 °C is mapped to fuzzy subsets *M* and *B*, and *M*(80) = 0.3, *B*(80) = 0.7; *e*<sub>2</sub> = 140 °C is mapped to fuzzy subsets *B* and *VB*, and *B*(140) = 0.2, *VB*(140) = 0.6; Four fuzzy rules *VB*<sub>(7)</sub>, *VB*<sub>(8)</sub>, *VB*<sub>(13)</sub> and *B*<sub>(14)</sub> in Table 2 are activated.

If the activated fuzzy outputs are *R*<sub>1</sub>, *R*<sub>2</sub>, *R*<sub>3</sub> and *R*<sub>4</sub>,

$$R_1 = (B(80) \wedge VB(140)) \cdot VB_{(7)} = (0.7 \wedge 0.6) \cdot VB_{(7)} = 0.6 \cdot VB_{(7)};$$

$$R_2 = (B(80) \wedge B(140)) \cdot VB_{(8)} = (0.7 \wedge 0.2) \cdot VB_{(8)} = 0.2 \cdot VB_{(8)};$$

$$R_3 = (M(80) \wedge VB(140)) \cdot VB_{(13)} = (0.3 \wedge 0.6) \cdot VB_{(13)} = 0.3 \cdot VB_{(13)};$$

$$R_4 = (M(80) \wedge B(140)) \cdot B_{(14)} = (0.3 \wedge 0.2) \cdot B_{(14)} = 0.2 \cdot B_{(14)}.$$

The fuzzy total output of current  $R = R_1 \cup R_2 \cup R_3 \cup R_4 = 0.6 \cdot VB_{(7)}$ , so the accurate output value of current corresponds to membership function *VB*(*x*) and membership degree is 0.6. The *VB*(*x*) function in formula (2) is  $0.6 = x - 12/20 - 12$ , and the calculated PLC output control signal is 16.8 mA.

### 5. Experimental Test

In order to verify the superiority of the temperature fuzzy control algorithm of the cable winding rod designed in this paper, a PID algorithm carried out with the cable heating furnace to control the temperature of the cable winding rod compares with the proposed method.

PID algorithm is widely used for temperature control in the industrial field [15]. A constant temperature and humidity cable heating furnace adopts a high-precision intelligent instrument as the temperature controller, PT100 as the temperature sensor, and the temperature control range is from −50 °C to 200 °C. An intelligent PID control algorithm is adopted and PID parameters are self-tuning in experiment. Taking 120 °C and 140 °C as the set values, the temperature control curves are shown in Figure 3.

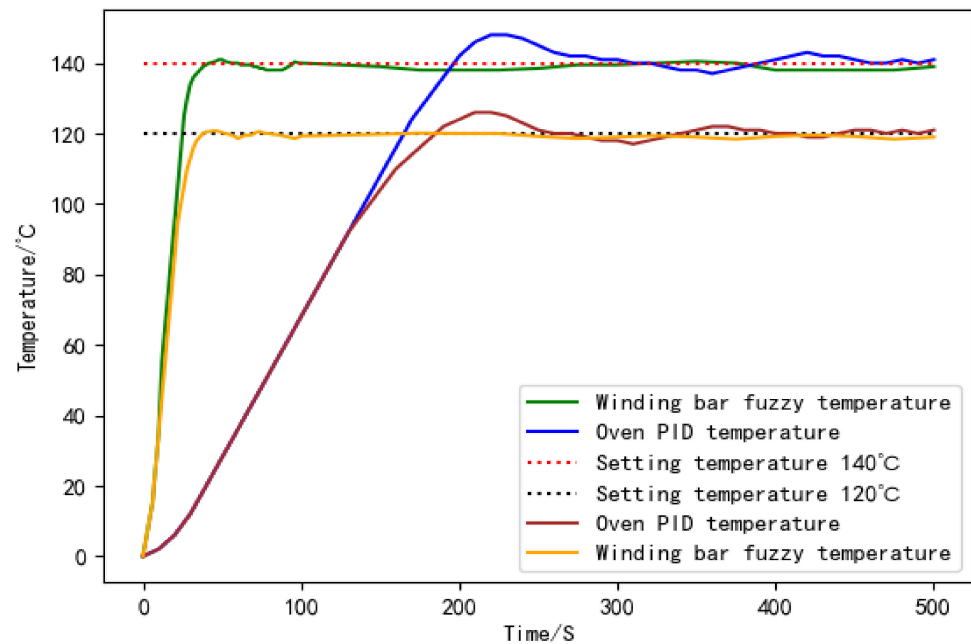

Figure 3. Comparison of temperature control effect.

The data in Figure 3 is summarized as follows:

It can be seen from Table 3 that under the condition of no load (helix), the adjustment time of PID control of the oven through the intelligent instrument is about 7~8 times that of the winding rod fuzzy control. Although the final steady state error is little different, the adjustment time is long and the fluctuation in the adjustment process is relatively large. The following experiments are carried out under the condition of load (helix).

Table 3. Experimental comparison.

Temperature Setting (°C)	Intelligent Instrument PID Control			Fuzzy Control of Winding Rod		
	Adjustment Time (s)	Maximum Deviation (°C)	Steady State Error (°C)	Adjustment Time (s)	Maximum Deviation (°C)	Steady State Error (°C)
120	320	6	1	42	1.2	0.4
140	350	8	1.8	48	1.5	0.5

Select the same type of TPU cable with the same length, and divide it into group A and group B. Place the winding rod of group a spring cable in a small oven, and heat it with wire baking method. Set the heating electrode on the winding rod of group B spring cable, and heat it with current heating method. The test temperature curves are shown in Figures 4 and 5, respectively.

In Figure 4, the heating medium temperature of the oven is set at 140 °C, the temperature of the oven slowly rise, and the temperature of the spring cable gradually rises with the temperature of the oven. Due to the poor thermal conductivity of the air, it takes about 350 s for the cable temperature to rise from room temperature to the process temperature. If the actual production large-scale curing barn is used, the heating time is far more than 350 s. In Figure 5, the winding rod can be heated to 160 °C after the electric heating medium of winding rod electrified for about 20 s. Since the cable is in close contact with the winding rod, the temperature of the cable rapidly rises, and the cable can be heated to 140 °C after about 60 s. Based on the fuzzy control algorithm, the current is automatically adjusted, the temperature of the winding rod gradually decreases, the temperature of the cable slowly rises, and finally approaches the temperature of the winding rod. The shaping effect of spring cable is shown in Figures 6 and 7.

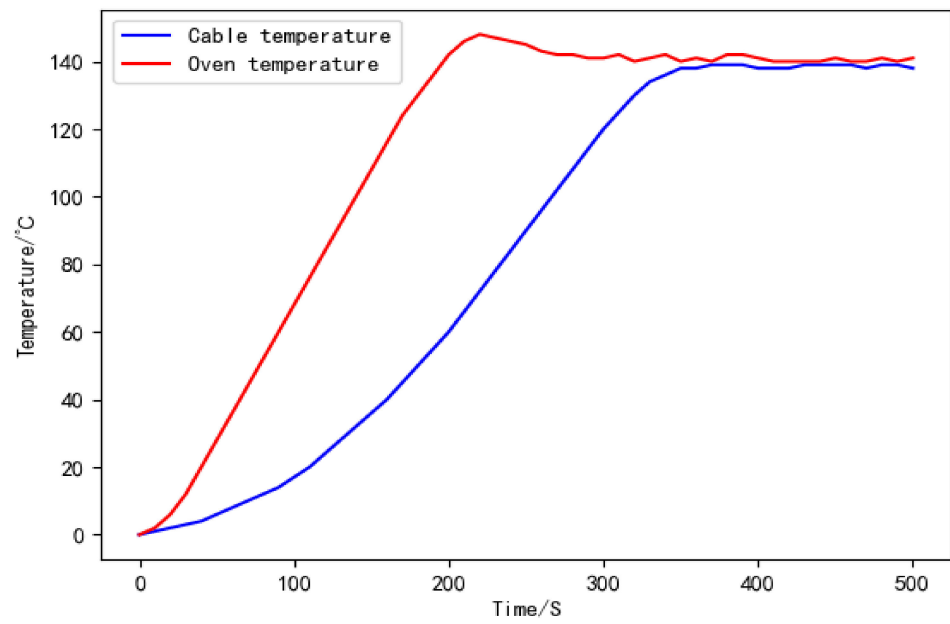

Figure 4. Temperature data curve of group A TPU spring cable baking method.

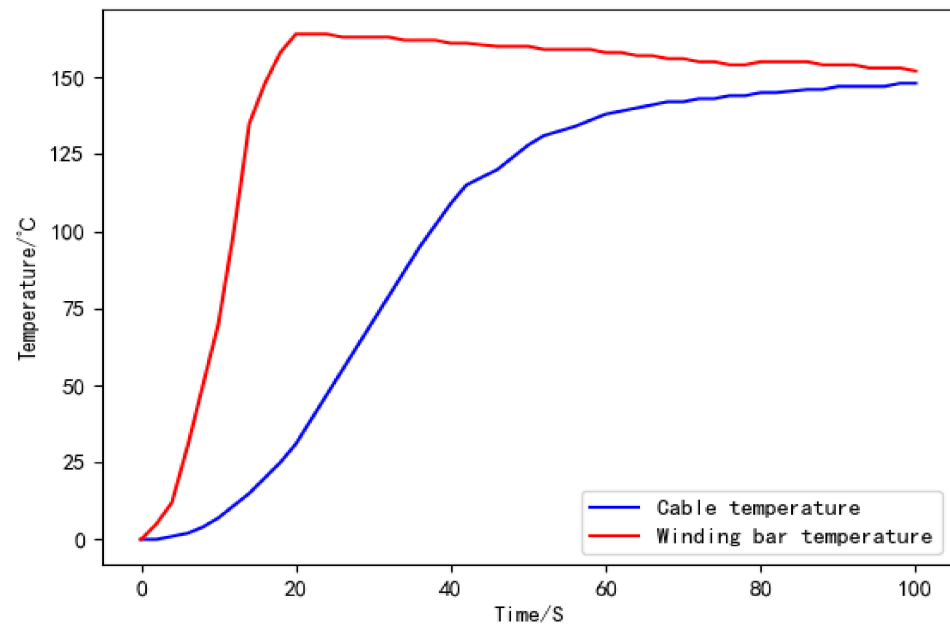
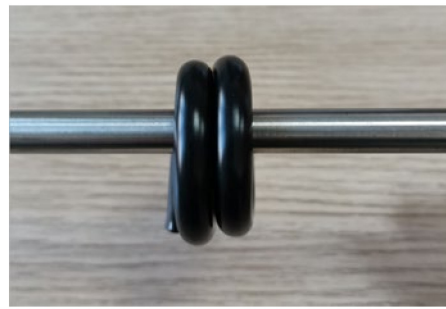

Figure 5. Temperature data curve of group B TPU spring cable winding rod electric heating method.



Figure 6. The shaping effect of spring cable using the wire baking method.





**Figure 7.** The shaping effect of spring cable using the current heating method.

In Figure 6, the wire baking method is used to heat for about 500 s, and the cold-water cooling method is used for 30 s. In Figure 7, the current heating method is used to heat for 100 s, and the water-cooling method is used for 30 s. It is obviously noted that the gap of the spring cable heated by the wire baking method in Figure 6 is larger, and the shaping effect of the spring cable is poorer in a short time comparing with the current heating method in Figure 7, and the spring cable heated by the current method is closely connected in Figure 7. So the current heating method has excellent performance and it is convenient for automatic mass production of spring cable.

## 6. Conclusions

Based on the research of spring cable shaping method, this paper innovatively develops a current heating method to directly heat the cable by energizing the winding rod, and adopts the fuzzy theory to construct the control algorithm of winding rod temperature and spring cable temperature, in order to realize the accurate control of spring cable current heating shaping temperature through current regulation. The experimental results show that comparing with the traditional shaping method, the current heating method can reduce the shaping time of spring cable from tens of minutes to a few minutes, so the proposed method effectively solve the problems of low production efficiency and the lengthy time the spring cable process currently taking, and effectively promote the development and application of automatic production line for spring cable processing.

**Author Contributions:** Conceptualization, J.Z. (Jianfeng Zhang) and L.H.; methodology, R.Y. and J.Z. (Jie Zhou); software, J.Z. (Jie Zhou); validation, R.Y. and J.Z. (Jie Zhou); formal analysis, R.Y.; investigation, T.T. and L.H.; resources, R.Y.; data curation, J.Z. (Jie Zhou); writing—original draft preparation, R.Y.; writing—review and editing, T.T. and J.Z. (Jie Zhou); visualization, J.Z. (Jie Zhou); supervision, J.Z. (Jianfeng Zhang); project administration, R.Y.; funding acquisition, T.T. All authors have read and agreed to the published version of the manuscript.

**Funding:** This research was funded by Natural Science Research Project of Universities of Jiangsu Province grant number 20KJB470032.

**Institutional Review Board Statement:** Not applicable.

**Informed Consent Statement:** Not applicable.

**Data Availability Statement:** The data is from production practice of the spring cable enterprise.

**Conflicts of Interest:** The authors declare no conflict of interest.

## References

1. Xing, E.; Zhou, C. Analysis of the bending behavior of a cable structure under microgravity. *Int. J. Mech. Sci.* **2016**, *114*, 132–140. [[CrossRef](#)]
2. Karathanasopoulos, N.; Reda, H.; Ganghoffer, J.-F. Finite element modeling of the elastoplastic axial-torsional response of helical constructions to traction loads. *Int. J. Mech. Sci.* **2017**, *133*, 368–375. [[CrossRef](#)]
3. Lee, D.; Fang, C.; Ravan, A.S.; Fuller, G.G.; Shen, A.Q. Temperature controlled tensiometry using droplet microfluidics. *Lab Chip* **2017**, *17*, 717–726. [[CrossRef](#)] [[PubMed](#)]

4. Duryodhan, V.; Singh, S.G.; Agrawal, A. The concept of making on-chip thermal cyclers for RT-PCR using conjugate heat transfer in diverging microchannel. *Trans. Indian Natl. Acad. Eng.* **2020**, *5*, 221–223. [[CrossRef](#)]
5. Kumar, D.; Tangirala, A.K. Adaptive Model Predictive Control of Module Temperature in Photovoltaic Systems. *Ind. Eng. Chem. Res.* **2021**, *60*, 4351–4365. [[CrossRef](#)]
6. Xiong, J.; Zhang, Z.; Chen, X. An Intelligent Compensation Method of Dynamic Coupling Error for Hydrostatic Guideway. *Evol. Comput. Mob. Sustain. Netw.* **2022**, *80*, 331–338. [[CrossRef](#)]
7. Sun, X.; Cao, J.; Lei, G.; Guo, Y.; Zhu, J. A robust deadbeat predictive controller with delay compensation based on composite sliding mode observer for PMSMs. *IEEE Trans. Power Electron.* **2021**, *36*, 10742–10752. [[CrossRef](#)]
8. Sun, X.; Zhang, Y.; Lei, G.; Guo, Y.; Zhu, J. An Improved Deadbeat Predictive Stator Flux Control with Reduced-Order Disturbance Observer for In-Wheel PMSMs. *IEEE/ASME Trans. Mechatron.* **2021**. [[CrossRef](#)]
9. Sun, X.; Li, T.; Zhu, Z.; Lei, G.; Guo, Y.; Zhu, J. Speed Sensorless Model Predictive Current Control Based on Finite Position Set for PMSM Drives. *IEEE Trans. Transp. Electrification.* **2021**, *7*, 2743–2752. [[CrossRef](#)]
10. Borzabadi, A.H.; Heidari, M. Discussion on Optimality Conditions of Fuzzy Optimal Control Problems. *Int. J. Uncertain. Fuzziness Knowl. Based Syst.* **2021**, *29*, 731–751. [[CrossRef](#)]
11. Elias, N.; Yahya, N.M. Fuzzy Logic Controller Optimized by MABSA for DC Servo Motor on Physical Experiment. *Lect. Notes Electr. Eng.* **2022**, *730*, 561–570.
12. Liu, D.; Liu, Z.; Chen, C.; Zhang, Y. Distributed adaptive fuzzy control approach for prescribed-time containment of uncertain nonlinear multi-agent systems with unknown hysteresis. *Nonlinear Dyn.* **2021**, *105*, 257–275. [[CrossRef](#)]
13. Su, X.; Wen, Y.; Yang, Y.; Shi, P. Dissipative Event-Triggered Fuzzy Control of Truck-Trailer Systems. *Intell. Transp. Syst.* **2022**, *385*, 245–265. [[CrossRef](#)]
14. Yang, H.; Zhang, Y.; Liang, J.; Zhang, N.; Paul, W. A robust deadbeat predictive power control with sliding mode disturbance observer for PWM rectifiers. In Proceedings of the 2017 IEEE Energy Conversion Congress and Exposition (ECCE), Cincinnati, OH, USA, 1–5 October 2017.
15. Paul, S.; Arunachalam, A.; Khodadad, D.; Andreasson, H.; Rubanenko, O. Fuzzy Tuned PID Controller for Envisioned Agricultural Manipulator. *Int. J. Autom. Comput.* **2021**, *18*, 568–580. [[CrossRef](#)]