

Article

A Study on the Field Applicability of Intermittent Irrigation in Protected Cultivation Using an Automatic Irrigation System

Sang-Hyeon Kang ¹, Youngjin Kim ^{1,*}, Sangbong Lee ², Heetae Kim ¹ and Minyoung Kim ¹¹ National Institute of Agricultural Sciences, Rural Development Administration, Jeonju 54875, Korea² Management Innovation and Legal Affairs, Rural Development Administration, Jeonju 54875, Korea

* Correspondence: mukta73@korea.kr

Abstract: The demand for efficient water use and automatic systems has been increasing due to the frequent drought damage to crops as a result of climate change, the shortage of water resources in rural areas, and the aging of farmers. The existing automatic irrigation systems reduce the amount of labor required for irrigation and maintain soil moisture. However, the irrigation threshold criteria are user-determined as opposed to being automated according to input objectives such as improving crop productivity and saving water. In this study, an algorithm that could automatically determine suitable soil moisture according to a database and an automatic irrigation system with intermittent irrigation for efficient water use were developed. An experiment was then conducted on the productivity of crops for protected cultivation according to the application of the system. As the frequency domain reflectometry (FDR) sensor used in this system measured the volumetric water content of the soil, the soil moisture tension corresponding with the set value was converted into the volumetric water content using a regression equation. The process of intermittent irrigation was defined by using the moisture movement modeling of Hydrus 2D to reduce water loss on the soil surface and allow moisture to penetrate the soil unobstructed. An experimental field of a tomato farm was divided into empirical manual and controlled automatic irrigation plots. A total of 97.3% of the soil moisture values in the -33 kPa-controlled automatic irrigation plot and 96.6% of the soil moisture values in the -25 kPa-controlled automatic irrigation plot were within each set range during the first cropping season. During the second cropping season, a total of 94.8% of the soil moisture values in the -33 kPa-controlled automatic irrigation plot was within the set range. Compared with the empirical manual irrigation plot, the water productivity in the first cropping season was 113.9% in the -33 kPa-controlled automatic irrigation plot and 106.3% in the -25 kPa-controlled automatic irrigation plot. In the second cropping season, the water productivity was 117.3% in the -33 kPa-controlled automatic irrigation plot. Therefore, an automatic irrigation system applied with intermittent irrigation could be critical to increasing agricultural production and improving water-use efficiency.

Keywords: irrigation method; moisture movement modeling; soil conditions; threshold criteria algorithm; tomato; upland crops



Citation: Kang, S.-H.; Kim, Y.; Lee, S.; Kim, H.; Kim, M. A Study on the Field Applicability of Intermittent Irrigation in Protected Cultivation Using an Automatic Irrigation System. *Appl. Sci.* **2022**, *12*, 10680. <https://doi.org/10.3390/app122010680>

Academic Editors:
Wojciech Janczukowicz and
Joanna Rodziewicz

Received: 1 September 2022

Accepted: 20 October 2022

Published: 21 October 2022

Publisher's Note: MDPI stays neutral with regard to jurisdictional claims in published maps and institutional affiliations.



Copyright: © 2022 by the authors. Licensee MDPI, Basel, Switzerland. This article is an open access article distributed under the terms and conditions of the Creative Commons Attribution (CC BY) license (<https://creativecommons.org/licenses/by/4.0/>).

1. Introduction

Global warming has far-reaching effects on housing, agriculture, livestock, and industrial activities as well as changes to natural ecosystems and human health [1]. Global warming increasingly impacts extreme weather events, including the drought through Europe from 1988 to 1992, the extreme drought of 1995 in northern England, and the prolonged drought in 2019 in the Pantanal region of South America in one of the world's largest wetlands [2–4]. Due to extreme weather events, droughts have occurred on the Korean Peninsula every year, either nationwide or regionally, since the 2000s. The Chungnam region in Korea has consistently had less precipitation than average since 2015 and the water level at Boryeong Dam dropped to an all-time low in June 2017, resulting in a water resource shortage [5].

According to the 2015 and 2020 Census of Agriculture, Forestry, and Fisheries in Korea, the number of farm households decreased by 53,325 (4.9%) in five years, from 1,088,518 in 2015 to 1,035,193 in 2020. The farm household population decreased by 255,323 (9.9%), from 2,569,387 in 2015 to 2,314,064 in 2020. In addition, over the last 17 years, Korea has rapidly shifted from an aging society with an aged population ratio of 7.3% in 2000 to an aged society with an aged population ratio of 14.2% in 2017. It is predicted to be a super-aged society by 2025. The proportion of the agricultural population aged 65 and over has also increased, to 38.4% in 2015 and 42.5% in 2020. In addition to the natural decline of the agricultural population, productivity has rapidly declined due to the rapid aging of the agricultural population [6,7].

To address these issues, irrigation automation technology that combines sensors and data with information and communications technology (ICT) has been actively researched. Water productivity and fruit quality were improved by applying an automatic irrigation system using subsurface drip irrigation (SSDI) method with date palms for optimal water use due to a lack of water resources [8]. A “smart” irrigation system using internet of things (IoT) technology provided acknowledgment messages about the status of jobs (e.g., the humidity level of soil, temperature of the surrounding environment, and status of the motor regarding the main power supply or solar power) and also saved water and electric power [9]. A low-cost intelligent smart irrigation system was developed for functions such as irrigation scheduling, decision-making, and remote monitoring using IoT [10]. An irrigation system with embedded controlled technology as a complete intelligent irrigation system enhanced the agricultural produce, improved the soil health, used water efficiently, and automated all aspects [11]. As such, automatic irrigation technology has developed in combination with IoT and ICT, for example.

Intermittent irrigation is one of the irrigation techniques that can save water, increase the crop yield, and reduce greenhouse gases (GHGs) by irrigating crops several times at regular intervals [12–14]. The effects of an intermittent flow, a dual-lateral drip system, and a physical barrier were evaluated on subsurface drip-irrigated tomatoes. The application of an intermittent flow maintained the wetting pattern at high moisture levels for a longer period of time and could be recommended to improve the quality of tomatoes [15]. A study was conducted to determine the effect of intermittent irrigation to mitigate climate damage whilst maintaining the crop yield. It was found that GHG emissions were alleviated without reducing the grain yield [16,17].

In this study, an automatic irrigation system with intermittent irrigation was developed and empirical field experiments were conducted, as more farms have been applying intermittent irrigation and adopting automatic irrigation systems to manage water shortages, prevent decreases in crop yields, and reduce GHG emissions. We developed an algorithm that provided users with soil moisture criteria, according to the crops and site conditions and it automatically controlled intermittent irrigation. An automatic irrigation system with the algorithm was developed. In addition, field experiments were conducted in protected cultivation to verify the water usage and crop productivity.

2. Materials and Methods

2.1. Algorithm

The existing automatic irrigation system used the algorithm shown in Figure 1 and required the user to input the soil moisture values used to trigger irrigation “on” and “off” [18]. It can be difficult for a user to determine the appropriate field capacity for the crop type, growth stage, soil texture, and soil bulk density. For this reason, the user may set the irrigation threshold criteria for the soil based on their own experience. The existing automatic irrigation system reduced the amount of labor required for irrigation and consistently managed the soil moisture. However, it would not be reliable if the irrigation threshold criteria were determined by the experience of the user; it needed data in order to improve the crop productivity and conserve water. Therefore, an algorithm, as shown in Figure 2, was developed that automatically provided the field capacity suitable for the

cultivation conditions. The developed algorithm automatically determined the minimum and maximum values of suitable soil moisture, according to selected data such as the crop name, planting date, soil texture, and bulk density based on the crop type and the soil moisture for the growth stages stored in the database. The system could then determine whether to start irrigation by comparing the soil moisture value measured in real time with the starting value. At the start of irrigation, intermittent irrigation was performed by operating the pump for a set number of times and periods. The system then determined whether to stop irrigation by comparing the soil moisture value measured in real time with the stop value.

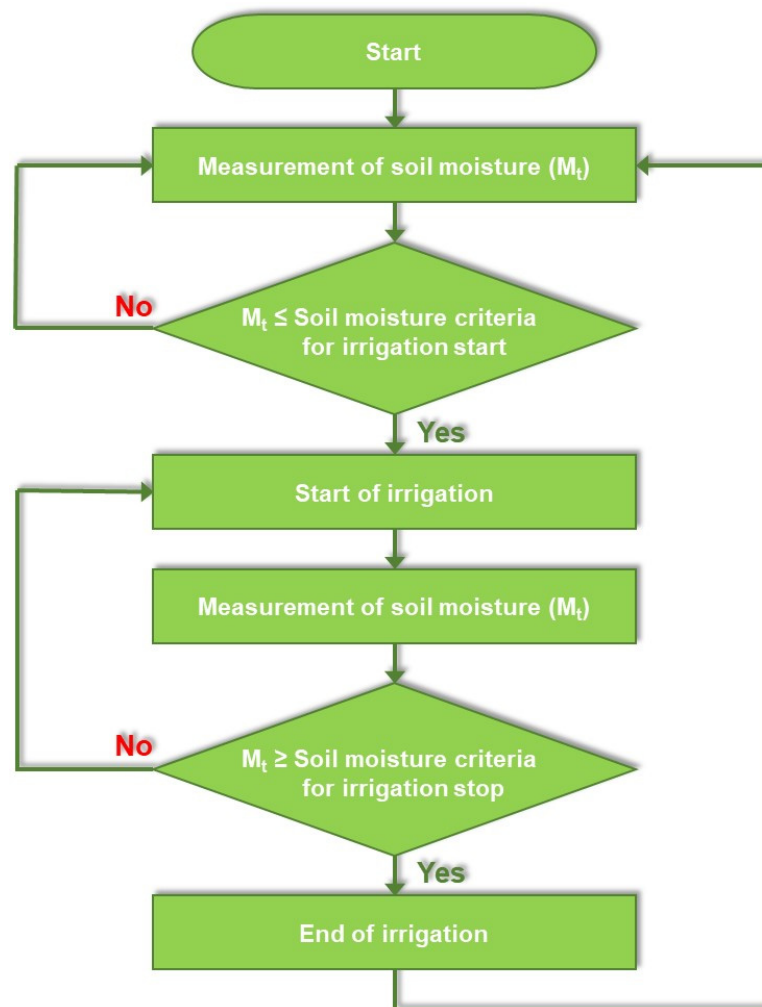

Figure 1. The existing algorithm for irrigation.

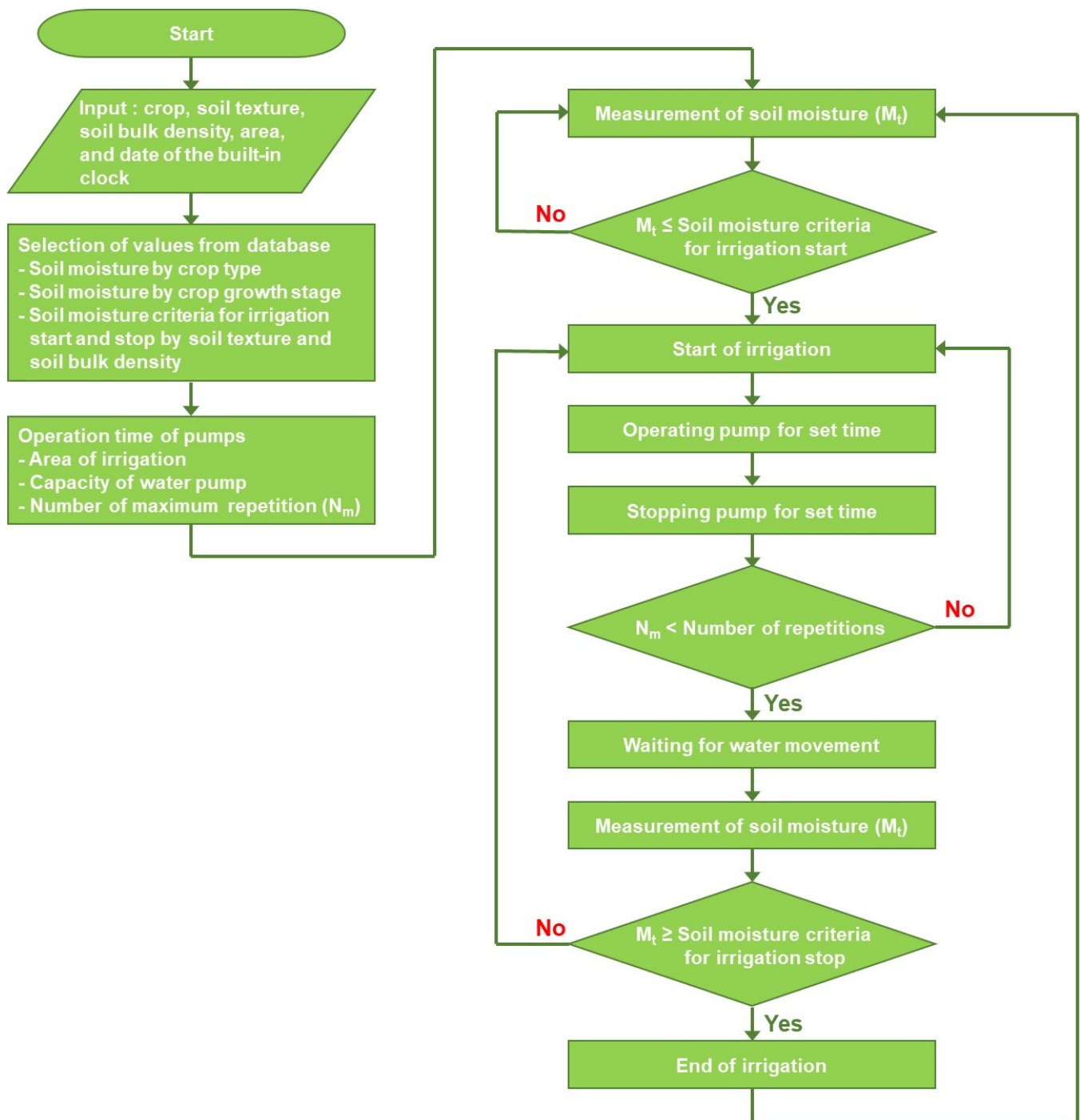

Figure 2. The algorithm for intermittent irrigation.

2.2. Automatic Irrigation System

An automatic irrigation system with the soil moisture information controlled the irrigation according to the soil moisture changes and irrigation threshold criteria in the field. It consisted of a sensor unit, a control unit, and a driving unit. The sensor unit measured the soil information in real time using an FDR sensor. The control unit was composed of a control panel that directed the device by calculating the set irrigation value using the soil moisture information measured by the sensor unit and an application set directly by remotely operating the control panel. Finally, the driving unit operated the electronic pump and solenoid valve to supply water to the soil.

The volumetric water content was the ratio of the volume of water to the unit volume of soil. There are various sensors for measuring the volumetric water content [19]. In this study, the volumetric water content was measured in real time using an FDR sensor that transmitted an electrical signal to the soil and measured the response through a frequency analysis using the difference in the permittivity of the soil and water. The FDR sensor (WT1000B, Mirae Sensor Co., Ltd., Seoul, Korea) used in this study had the ability to measure the volumetric water content, soil electrical conductivity (EC), and soil temperature. Figure 3 shows the FDR sensor and Table 1 shows the specifications of the FDR sensor.



Figure 3. The photos of the FDR sensor.

Table 1. The specification of the FDR sensor.

Measuring Range	Accuracy	Operating Temperature
Moisture: 0–99.9%	Moisture: $\pm 1\%$	0 °C–60 °C
Soil EC: 0–6.0 dS/m	Soil EC: ± 0.1 dS/m	
Temperature: 0 °C–60 °C	Temperature: ± 0.5 °C	

Pressure pumps were used to supply water at an appropriate pressure and solenoid valves were used to regulate the flow of water by a remote control. Figure 4 is a photo of the pumps and valves that were set up in the field. Using the soil moisture information measured by the FDR sensor, the control panel operated the pressure pump and solenoid valve to irrigate the soil. In addition, users could directly remotely operate the control panel through a mobile application on an Android OS. Figure 5 shows the control panel location during the experiment.



Figure 4. The photo of the pressure pumps and solenoid valves in the experimental field.

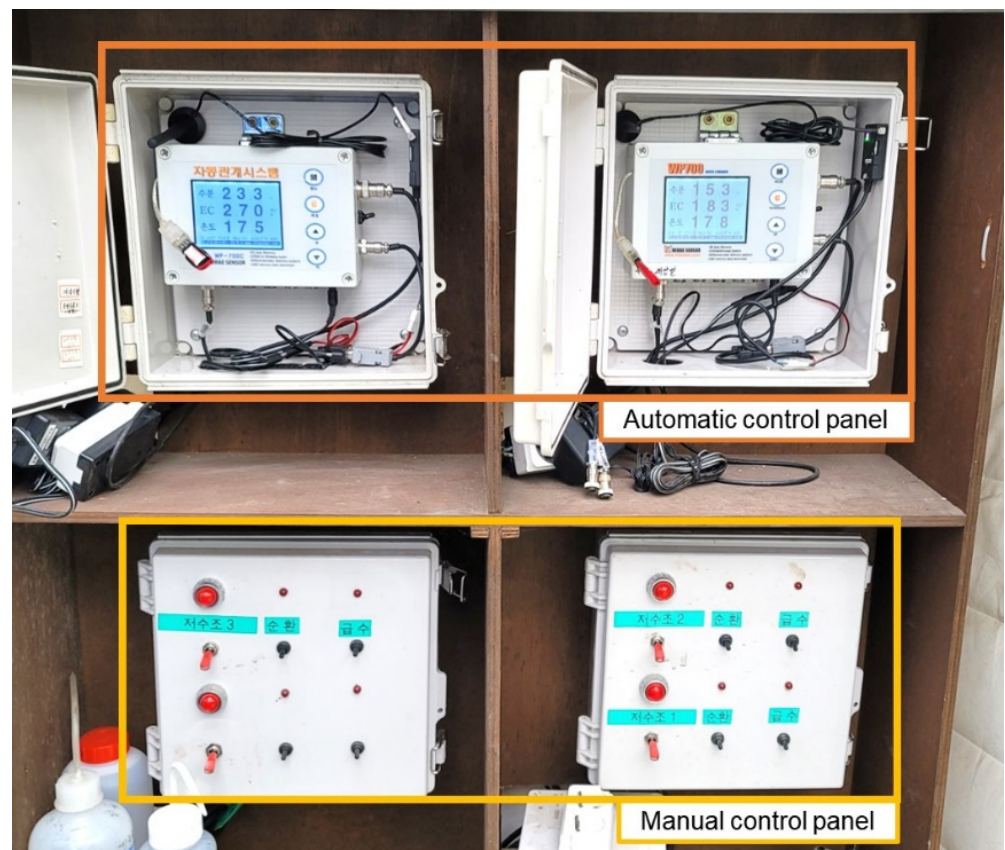

Figure 5. The picture of the control panel in the experiment.

2.3. Empirical Field Experiments

The empirical field experiments were conducted on a tomato farm in protected cultivation with an area of 3903 m²; 400 m² of the cultivation area was used as the experimental field. We conducted the experiment during the first and second cropping seasons. The soil texture of the experimental field was silty loam with 32.0% sand, 51.6% silt, and 16.4%

clay [20]. The soil moisture tension of the Korean field capacity was -33 kPa and the soil moisture tension of the 60% vicinity of the difference between the maximum water capacity and the field capacity was -25 kPa. Therefore, the soil moisture criteria were set at -33 kPa and -25 kPa [21]. As the FDR sensor measured the volumetric water content of the soil, a regression equation was deduced from the data converted from the soil moisture tension to the volumetric water content [22,23]. By using this regression equation, a volumetric water content corresponding with the set value was obtained. The set scales of the volumetric water content for the soil moisture control were set from 24% to 34% in the -33 kPa-controlled automatic irrigation plot and from 26% to 34% in the -25 kPa-controlled automatic irrigation plot. Figure 6 shows the graph and formula for the conversion from the soil moisture tension to the volumetric water content.

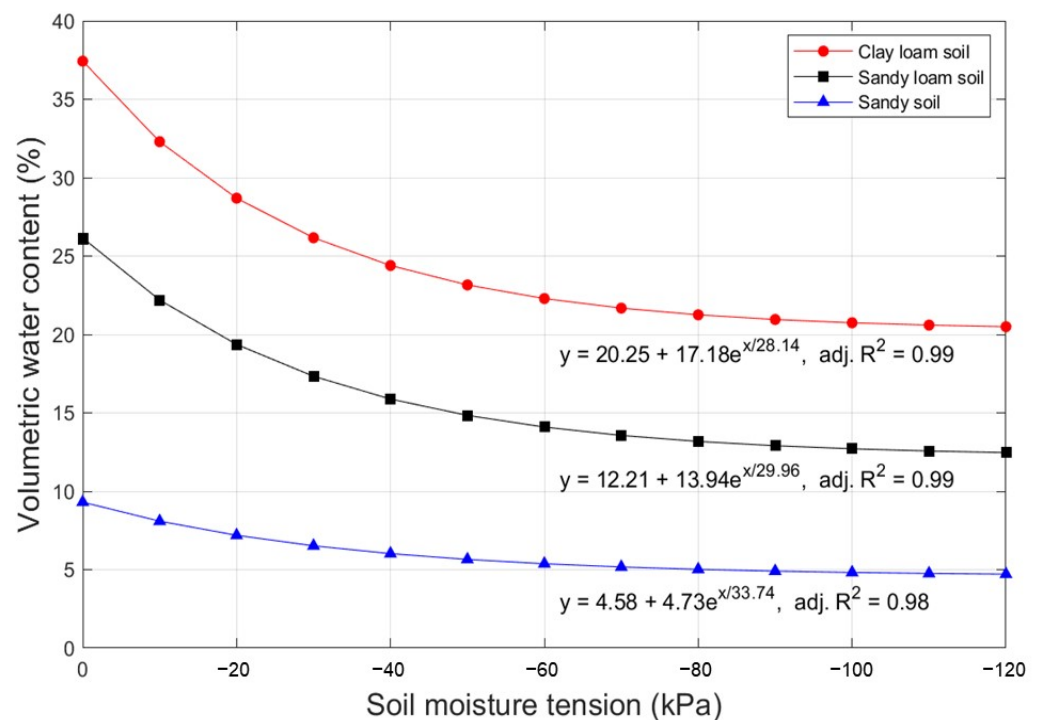

Figure 6. The formula to convert soil moisture tension to volumetric water content.

The empirical manual irrigation plot was manually irrigated according to the experience of a farmer. Furrow irrigation was used in the first cropping season and drip irrigation was used in the second cropping season. The controlled automatic irrigation plots used intermittent irrigation via the automatic irrigation system that referred to the moisture movement modeling for each soil texture using Hydrus 2D software [12,24,25]. The conditions of intermittent irrigation were that the irrigation depth was 1.7 mm, the irrigation interval was 40 min, and irrigation was performed three times [12]. The experimental field was automatically irrigated from 7 a.m. to 3 p.m. when the evapotranspiration of plants was active [26]. A schematic diagram of the automatic irrigation system is shown in Figure 7 and a photo of the experimental field where the automatic irrigation system was installed is shown in Figure 8.

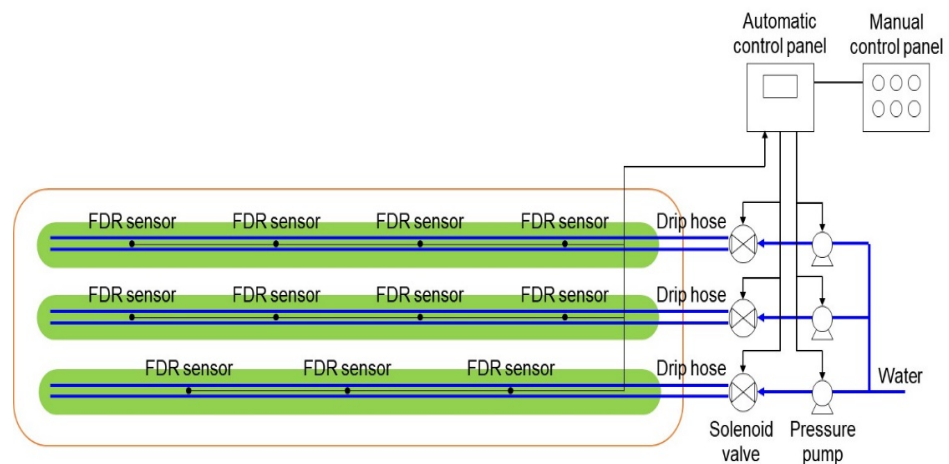

Figure 7. The schematic diagram of the experimental field with the automatic irrigation system.

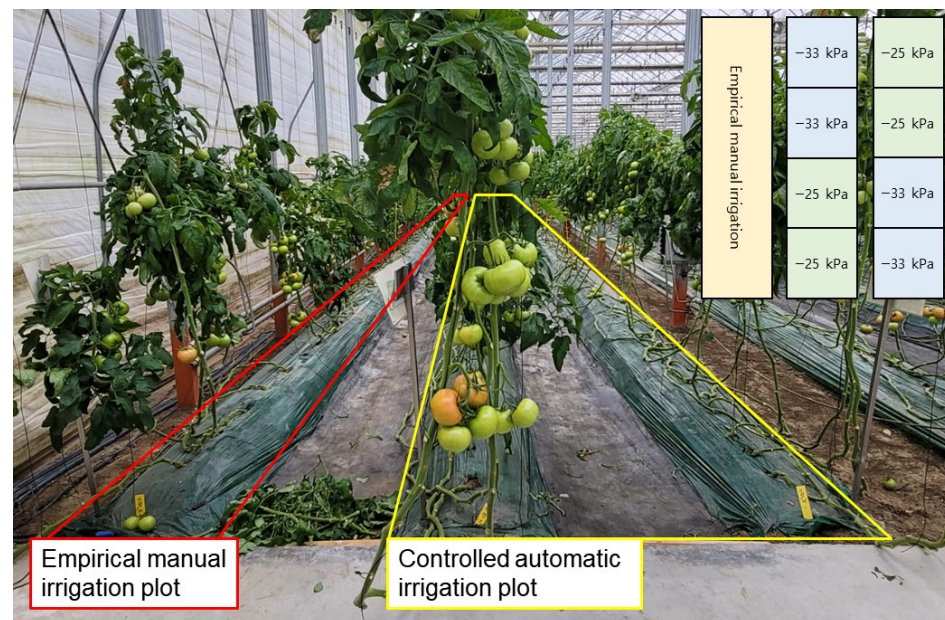

Figure 8. The picture of the experimental field on a tomato farm in the first cropping season.

3. Results

3.1. Control of the Soil Moisture

The results of soil moisture control were that 97.3% of the soil moisture values measured in real time in the -33 kPa-controlled automatic irrigation plot and 96.6% of the soil moisture values measured in real time in the -25 kPa-controlled automatic irrigation plot fell within their set ranges during the first cropping season. Figure 9 shows the results of the comparison between the controlled automatic irrigation plot and the empirical manual irrigation plot during the first cropping season as a graph. The results of the soil moisture control were that 94.8% of the soil moisture values measured in real time in the -33 kPa-controlled automatic irrigation plot fell within their set ranges during the second cropping season. Figure 10 shows the results of the comparison between the -33 kPa-controlled automatic irrigation plot and the empirical manual irrigation plot during the second cropping season as a graph. The black graphs in Figures 9 and 10 show the experimental results of the irrigation based on the experience of the user in the empirical manual irrigation plot. The user could not quantitatively recognize the soil moisture content and the irrigation amount was not constant, showing uneven soil moisture values. However, the blue and green graphs are the soil moisture values of the controlled automatic irrigation plots. Most

of the soil moisture values were distributed within the set range by automatic irrigation using the automatic irrigation system.

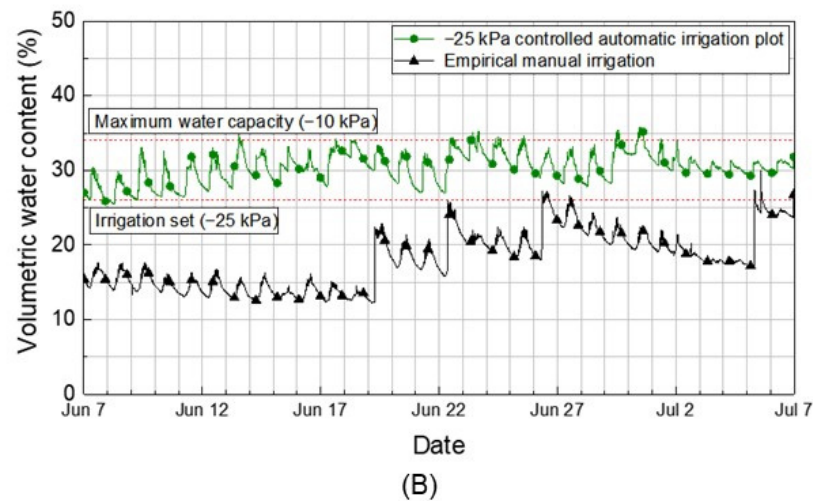
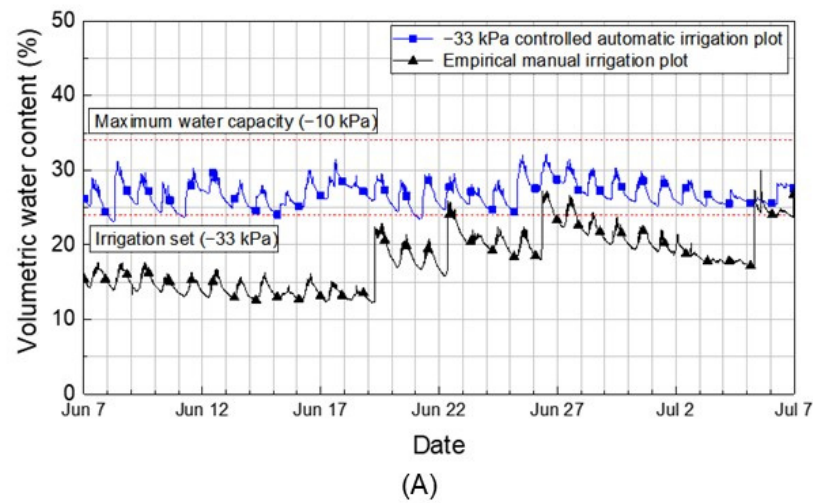

Figure 9. The results of soil moisture control in the experimental field during the first cropping season: (A) -33 kPa-controlled automatic irrigation plot; (B) -25 kPa-controlled automatic irrigation plot.

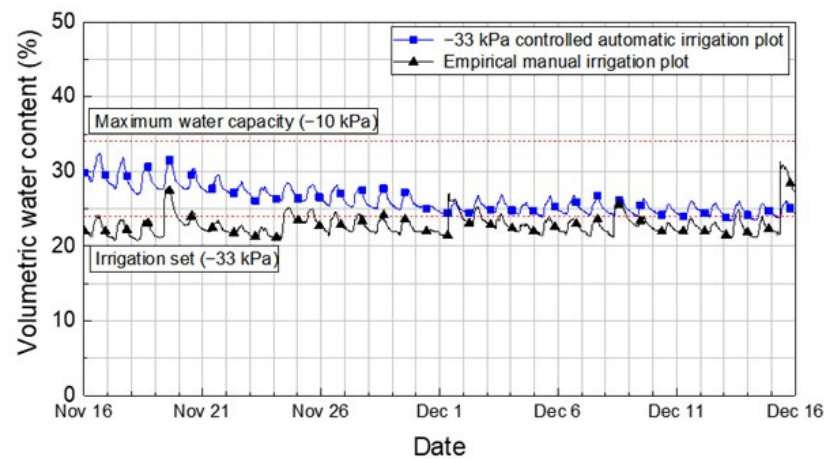

Figure 10. The results of soil moisture control in the -33 kPa-controlled automatic irrigation plot during the second cropping season.

3.2. Crop Yield, Irrigation Amount, and Water Productivity in the Experimental Field

Table 2 shows the results of the first cropping season. The production of tomatoes in the -25 kPa-controlled automatic irrigation plot was the highest at 8178 kg/10a ($10a = 1000 \text{ m}^2$), followed by 7147 kg/10a in the -33 kPa-controlled automatic irrigation plot and 6577 kg/10a in the empirical manual irrigation plot [20]. The largest amount of water was irrigated— $323.6 \text{ m}^3/10a$ —in the -25 kPa-controlled automatic irrigation plot and the smallest amount of water was irrigated— $264.0 \text{ m}^3/10a$ —in the -33 kPa-controlled automatic irrigation plot. The ratio of the crop yield was 108.7% in the -33 kPa-controlled automatic irrigation plot and 124.3% in the -25 kPa-controlled automatic irrigation plot compared with the empirical manual irrigation plot. Furthermore, the ratio of the water consumption in the -33 kPa-controlled automatic irrigation plot was lower at 95.5% and the -25 kPa-controlled automatic irrigation plot was higher at 117.1%. Water productivity determined the efficient use of water by the crop yield per cubic meter of water consumption [27]. It was 23.8 kg/m^3 for the empirical manual irrigation plot, 27.1 kg/m^3 for the -33 kPa-controlled automatic irrigation plot, and 25.3 kg/m^3 for the -25 kPa-controlled automatic irrigation plot, among which the -33 kPa-controlled automatic irrigation plot showed the highest results. The -25 kPa-controlled automatic irrigation plot produced more crops than the -33 kPa-controlled automatic irrigation plot, but the water consumption was also higher. Therefore, the -33 kPa-controlled automatic irrigation plot had the most efficient use of water.

Table 2. Crop yield, irrigation amount, and water productivity by each plot in the first cropping season.

Plot	Crop Yield (kg/10a)	Irrigation Amount ($\text{m}^3/10a$)	Ratio of Empirical Manual Irrigation Plot (%)		Water Productivity (kg/m^3)
			Crop Yield	Irrigation Amount	
Empirical manual irrigation	6577	276.4	100	100	23.8
-33 kPa automatic irrigation	7147	264.0	108.7	95.5	27.1
-25 kPa automatic irrigation	8178	323.6	124.3	117.1	25.3

Table 3 shows the results of the second cropping season with minimal irrigation on the -33 kPa-controlled automatic irrigation plot to increase the water productivity. The tomato yield of 3879 kg/10a in the -33 kPa-controlled automatic irrigation plot was higher than the tomato yield of 3826 kg/10a in the empirical manual irrigation plot [20]. The empirical manual irrigation plot was irrigated with $75.36 \text{ m}^3/10a$ of water and the -33 kPa-controlled automatic irrigation plot was irrigated with $65.04 \text{ m}^3/10a$ of water, so the empirical manual irrigation plot was irrigated with more water. The ratio of the crop yield was 101.4% in the -33 kPa-controlled automatic irrigation plot compared with the empirical manual irrigation plot. Furthermore, the ratio of water consumption in the -33 kPa-controlled automatic irrigation plot was 86.3% compared with the empirical manual irrigation plot. The water productivity was 50.8 kg/m^3 for the empirical manual irrigation plot and 59.6 kg/m^3 for the -33 kPa-controlled automatic irrigation plot, among which the -33 kPa-controlled automatic irrigation plot showed the higher result. Therefore, the -33 kPa-controlled automatic irrigation plot had the more efficient use of water.

Table 3. Crop yield, irrigation amount, and water productivity by each plot in the second cropping season.

Plot	Crop Yield (kg/10a)	Irrigation Amount (m ³ /10a)	Ratio of Empirical Manual Irrigation Plot (%) Crop Yield	Ratio of Empirical Manual Irrigation Plot (%) Irrigation Amount	Water Productivity (kg/m ³)
Empirical manual irrigation	3826	75.36	100	100	50.8
−33 kPa automatic irrigation	3879	65.04	101.4	86.3	59.6

4. Conclusions

In this study, an algorithm was developed to suggest the soil moisture criteria by providing appropriate soil moisture values based on the conditions. By applying this algorithm to the system, an automatic irrigation system capable of controlling the soil moisture was developed and its field applicability was confirmed.

The existing automatic irrigation system irrigated a predetermined amount when the soil moisture value fell below a set value. Therefore, it had the disadvantage that it could not respond to many variables such as the crop type, growth stage, soil texture, and soil bulk density. To compensate for these shortcomings, an algorithm for determining the soil moisture criteria based on the crop type, growth stage, soil texture, and soil bulk density was developed and applied to the automatic irrigation system. Intermittent irrigation with reference to the soil moisture movement modeling was performed on an experimental field using the automatic irrigation system. Moreover, the soil moisture control, crop yield, and water consumption were verified.

As a result of the empirical field experiments, it was confirmed that it could be effectively used in the field as the soil moisture control values fell within each set range and it showed a higher crop yield and water productivity compared with the empirical manual irrigation plot. In the future, we plan to conduct research on the application of automatic irrigation systems in consideration of various influences such as evapotranspiration and climatic conditions by weighing lysimeters and agroclimatic stations [28,29].

Author Contributions: Conceptualization, Y.K., S.L. and M.K.; methodology, Y.K.; software, S.-H.K.; validation, S.-H.K., Y.K., S.L., H.K. and M.K.; formal analysis, S.-H.K. and Y.K.; investigation, S.-H.K.; resources, S.L. and H.K.; data curation, S.-H.K. and Y.K.; writing—original draft preparation, S.-H.K.; writing—review and editing, S.-H.K., Y.K., S.L., H.K. and M.K.; visualization, S.-H.K. and Y.K.; supervision, S.L.; project administration, S.L.; funding acquisition, M.K. All authors have read and agreed to the published version of the manuscript.

Funding: This work was carried out with the support of the Cooperative Research Program for Agriculture Science & Technology Development (Project No. PJ013537032021) Rural Development Administration, Korea.

Institutional Review Board Statement: Not applicable.

Informed Consent Statement: Not applicable.

Data Availability Statement: Not applicable.

Conflicts of Interest: The authors declare no conflict of interest.

References

1. Houghton, J. Global warming. *Rep. Prog. Phys.* **2005**, *68*, 1343. [[CrossRef](#)]
2. Marsh, T.; Monkhouse, R.; Arnell, N.; Lees, M.; Reynard, N. *The 1988–1992 Drought*; NERC Institute of Hydrology: Wallingford, UK, 1994; pp. 1–11.
3. Buckland, S.; Grime, J.; Hodgson, J.; Thompson, K. A comparison of plant responses to the extreme drought of 1995 in northern England. *J. Ecol.* **1997**, *85*, 875–882. [[CrossRef](#)]

4. Marengo, J.A.; Cunha, A.P.; Cuartas, L.A.; Deusdara Leal, K.R.; Broedel, E.; Seluchi, M.E.; Michelin, C.M.; De Praga Baião, C.F.; Chuchón Angulo, E.; Almeida, E.K. Extreme drought in the Brazilian Pantanal in 2019–2020: Characterization, causes, and impacts. *Front. Water* **2021**, *3*, 13. [[CrossRef](#)]
5. Gwak, Y.; Cho, J.; Jung, I.; Kim, D.; Jang, S. Projection of Future Changes in Drought Characteristics in Korea Peninsula Using Effective Drought Index. *J. Clim. Change Res.* **2018**, *9*, 31–45. [[CrossRef](#)]
6. Statistics_Korea. Census of Agriculture, Forestry, and Fisheries. Available online: <https://affcensus.go.kr/mainView.do> (accessed on 1 April 2020).
7. Song, J.-H.; Kim, T.-O. The vinylhouse automatic control system using aging society of the farm village. *J. Korea Acad.-Ind. Coop. Soc.* **2011**, *12*, 3164–3168. [[CrossRef](#)]
8. Alnaim, M.A.; Mohamed, M.S.; Mohammed, M.; Munir, M. Effects of Automated Irrigation Systems and Water Regimes on Soil Properties, Water Productivity, Yield and Fruit Quality of Date Palm. *Agriculture* **2022**, *12*, 343. [[CrossRef](#)]
9. Krishnan, R.S.; Julie, E.G.; Robinson, Y.H.; Raja, S.; Kumar, R.; Thong, P.H. Fuzzy logic based smart irrigation system using internet of things. *J. Clean Prod.* **2020**, *252*, 119902. [[CrossRef](#)]
10. Nawandar, N.K.; Satpute, V.R. IoT based low cost and intelligent module for smart irrigation system. *Comput. Electron. Agric.* **2019**, *162*, 979–990. [[CrossRef](#)]
11. Rajendrakumar, S.; Parvati, V. Automation of irrigation system through embedded computing technology. In Proceedings of the 2019 the 3rd International Conference on Cryptography, Security and Privacy, Kuala Lumpur, Malaysia, 19 January 2019.
12. Kim, Y.-J.; Kang, S.-H.; Lee, S.-B.; Kim, H.-T.; Kim, M.-Y.; Kim, H.-J. A Moisture Movement Modelling for Intermittent Irrigation under Varying Soil Conditions in Protected Cultivation. *J. Agric. Life Sci.* **2021**, *55*, 91–101. [[CrossRef](#)]
13. Hong, E.-M.; Choi, J.-Y.; Nam, W.-H.; Lee, S.-H.; Choi, J.-K.; Kim, J.-T. Analysis of water loss rate and irrigation efficiency in irrigation canal at the Dong-Jin district. *J. Korean Soc. Agric. Eng.* **2015**, *57*, 93–101. [[CrossRef](#)]
14. Kim, G.-Y.; Park, W.-K.; Lee, S.-I.; Lee, J.-S.; Choi, E.-J.; Na, U.-S.; Jang, H.-Y.; Suh, S.-U. Mitigation of greenhouse gas emissions (GHGs) by water management methods in rice paddy field. *KJSSF* **2015**, *48*, 477–484. [[CrossRef](#)]
15. Elnesr, M.N.; Alazba, A.A.; Zein El-Abedein, A.I.; El-Adl, M.M. Evaluating the effect of three water management techniques on tomato crop. *PLoS ONE* **2015**, *10*, e0129796. [[CrossRef](#)] [[PubMed](#)]
16. Choi, J.; Uphoff, N.; Kim, J.; Lee, S. Greenhouse Gas Reduction from Paddy by Environmentally-Friendly Intermittent Irrigation: A Review. *J. Wetl. Res.* **2019**, *21*, 43–56. [[CrossRef](#)]
17. Cheng, C.; Yang, X.; Wang, J.; Luo, K.; Rasheed, A.; Zeng, Y.; Shang, Q. Mitigating net global warming potential and greenhouse gas intensity by intermittent irrigation under straw incorporation in Chinese double-rice cropping systems. *Paddy Water Environ.* **2020**, *18*, 99–109. [[CrossRef](#)]
18. Zhu, H.-H.; Huang, Y.-X.; Huang, H.; Garg, A.; Mei, G.-X.; Song, H.-H. Development and Evaluation of Arduino-Based Automatic Irrigation System for Regulation of Soil Moisture. *Int. J. Geosynth. Ground Eng.* **2022**, *8*, 1–9. [[CrossRef](#)]
19. SU, S.L.; Singh, D.; Baghini, M.S. A critical review of soil moisture measurement. *Measurement* **2014**, *54*, 92–105. [[CrossRef](#)]
20. NAS. *Establishing the Guideline of Automatically Controlling Water and Nutrient Supply in Greenhouse Soils*; National Institute of Agricultural Sciences (NAS): Wanju, Korea, 2021.
21. NAS. *The Technology of Irrigation Schedule According to Soil, Crops, and Regions*; Rural Development Administration: Wanju, Korea, 2018.
22. Zhang, Y.; Han, K.; Cho, H.; Ok, J.; Jang, S.; Hwang, S.; Jung, K. Relationship between Soil Moisture Tension and Volumetric Content with Soil Textural Classes and Bulk Density. In Proceedings of the 2018 KSSSF Spring Conference, Jeonju, Korea, 17–18 May 2018.
23. Kim, H.-J.; Son, D.-W.; Hur, S.-O.; Roh, M.-Y.; Jung, K.-Y.; Park, J.-M.; Rhee, J.-Y.; Lee, D.-H. Comparison of wetting and drying characteristics in differently textured soils under drip irrigation. *J. Bio.-Env. Con.* **2009**, *18*, 309–315.
24. Kim, D.H.; Kim, J.S.; Kwon, S.H.; Park, J.M.; Choi, W.S. Simulation of Soil Water Movement in Upland Soils Under Pulse Irrigation using HYDRUS-2D. *J. Biosyst. Eng.* **2021**, *46*, 508–516. [[CrossRef](#)]
25. Kim, J.H.; Kim, T.W.; Kim, S.H.; Lee, H.G.; Eum, D.H.; Lee, S.H. A Study on the Application Design of Soil Moisture Diffusion and Crop Roots According to Subsurface Irrigation Method. *J. Biosyst. Eng.* **2021**, *46*, 197–205. [[CrossRef](#)]
26. Kim, S.-C.; Lee, H.-J.; Park, B.-J. Assessment of temperature reduction and evapotranspiration of green roof planted with *Zoysia japonica*. *J. Environ. Sci. Int.* **2013**, *22*, 1443–1449. [[CrossRef](#)]
27. Heydari, N. Water productivity in agriculture: Challenges in concepts, terms and values. *Irrig. Drain.* **2014**, *63*, 22–28. [[CrossRef](#)]
28. Young, M.; Wierenga, P.; Mancino, C. Large weighing lysimeters for water use and deep percolation studies. *Soil Sci.* **1996**, *161*, 491–501. [[CrossRef](#)]
29. Amarasingha, R.; Suriyagoda, L.; Marambe, B.; Gaydon, D.; Galagedara, L.; Punyawardena, R.; Silva, G.; Nidumolu, U.; Howden, M. Simulation of crop and water productivity for rice (*Oryza sativa* L.) using APSIM under diverse agro-climatic conditions and water management techniques in Sri Lanka. *Agric. Water Manag.* **2015**, *160*, 132–143. [[CrossRef](#)]