

Article

Active Strategies Based on Parametric Design for Applying Shading Structures

Ho-Soon Choi 

Department of Architecture, Gachon University, 1342 Seongnamdaero, Sujeong-gu, Seongnam-si 13120, Gyeonggi-do, Republic of Korea; hosoon@gachon.ac.kr; Tel.: +82-31-750-5519

Abstract: This study aimed to increase the energy independence of buildings by utilizing solar energy to produce renewable energy. The subject of this study was a shading structure installed in an outdoor space to provide solar energy. Solar panels were applied to the shaded structures to generate energy actively. The solar panels were designed to be moved according to the optimal tilt angle each month to produce the optimal amount of renewable energy. The architectural design of the shading structure and the energy simulation of the solar panels were conducted using a parametric design. The results of the energy simulation showed the generation of 31,570 kWh·year⁻¹ of renewable energy. This amount of energy is 10% higher than that produced by fixed solar panels. Thus, the moving solar panel system developed in this study not only increases the energy independence of buildings, but also has the advantage of higher renewable energy production compared with fixed solar panels. Additionally, various types of shading structures can be designed depending on the combination of solar panel modules; in particular, moving solar panels have the potential to facilitate ecofriendly designs when applied to the exterior of buildings.

Keywords: active design strategies; energy-efficient architecture; solar panel system; parametric design; shading structure



Citation: Choi, H.-S. Active Strategies Based on Parametric Design for Applying Shading Structures. *Appl. Sci.* **2024**, *14*, 974. <https://doi.org/10.3390/app14030974>

Academic Editors: David Bienvenido Huertas and Daniel Sánchez-García

Received: 3 January 2024

Revised: 15 January 2024

Accepted: 22 January 2024

Published: 23 January 2024



Copyright: © 2024 by the author. Licensee MDPI, Basel, Switzerland. This article is an open access article distributed under the terms and conditions of the Creative Commons Attribution (CC BY) license (<https://creativecommons.org/licenses/by/4.0/>).

1. Introduction

Climate change caused by environmental pollution is progressing rapidly. Industries need to be reorganized to reduce environmental pollution to preserve the global environment for the survival of mankind. The construction sector directly contributes to environmental pollution through energy consumption. Changes in the energy consumption in the construction field are an important factor affecting the global environment, given that the energy consumption of the construction sector accounted for 37% of the global energy consumption in 2022 [1]. Consequently, technological development related to efficient energy consumption and renewable energy production in buildings is essential. Accordingly, the International Energy Agency announces energy reduction goals for the construction sector every year. To achieve these goals, each country specifically reduces building energy consumption and CO₂ emissions through Building Energy Sufficiency policies [2,3]. In addition, energy-related studies in the field of architecture are actively being conducted to generate renewable energy in buildings.

Clean and efficient building energy systems can be divided into active and passive energy-saving systems. Active energy-saving systems generate energy within a building using solar thermal panels, photovoltaic systems, wind power, and geothermal energy. Passive energy-saving systems conserve building energy and minimize building energy consumption through the insulation of the exterior and roof of the building and the installation of highly energy-efficient windows [4–7]. Recently, studies have been conducted on complex, clean, and efficient building energy systems that combine active and passive energy-saving systems. Studies have been conducted to develop an energy system optimization model and policies for model operation under the premise that a method

combining active and passive energy-saving systems has the potential to reduce building energy costs [8,9]. An empirical study was conducted to apply the developed energy-saving system model to specific buildings. To increase the energy use efficiency of public institutions and schools, studies have been conducted on the development of energy combination models and algorithms [10,11] and on active and passive energy-saving systems to increase the energy independence of residential buildings [12,13].

This study conducted architectural research based on active design strategies. The active design strategy pursued in this study involved increasing the energy independence of buildings by utilizing solar energy from various natural energy sources. Second, this study targeted buildings that were easy to construct. In this study, buildings that could be constructed within a short period without applying professional construction methods were selected. From an active design perspective, buildings that are easy to construct were selected as the research objects to maximize the effect of renewable energy generated by the building compared with construction costs. The solar panel used to utilize solar energy is not a fixed type, but a mobile model based on a parametric design for optimal energy harvesting. The experimental process was designed to present a model of creative architectural design.

The building selected for this study was a shaded structure. The modularization of the elements that constitute the structure and the ease of the construction process satisfy the attributes of active design. This empirical study serves as an experimental model for an energy-efficient architectural design that can be used as a shelter for outdoor spaces needed for outdoor activities.

2. Literature Review

2.1. Active Design Based on Solar Panel System for Energy-Efficient Architecture

The photovoltaic effect, which generates energy from sunlight, was first introduced by the French physicist Alexandre Edmond Becquerel in 1839. Solar cells were first used as an energy source when they were deployed as a power source for communication networks in Americus, Georgia in 1955 [14,15]. Solar panels were first applied in the architectural field by American architects and engineers just before World War II up to the late 1950s. After the war, as concerns about energy supply and global environmental problems emerged, interest in the development of ecofriendly architectures that utilize solar energy increased. However, as oil energy was used as the main energy source at the time, interest in solar energy decreased, whereas interest in renewable energy increased again following the oil crisis of the 1970s [16]. Today, solar-energy-based active designs are being applied to various buildings because of the global interest in low carbon emissions and energy savings in all industrial fields.

The methods for utilizing solar energy in the construction sector can be broadly divided into two types. First, some buildings produce electrical energy from solar energy. This method involves installing a solar power generation system in a building. Solar cells are installed on the roofs of buildings to convert the natural energy of sunlight into electrical energy. Second, some buildings produce heat energy from solar energy. Solar collectors are installed on the roofs of buildings to produce energy for heating water [17,18].

Solar panels installed in buildings are placed on the rooftops of the buildings to expose the solar panels fully to sunlight and facilitate their maintenance. Building-integrated photovoltaics (BIPVs) are widely used to install solar panels on sloped roofs and building façades rather than on flat roofs [19]. Before applying BIPVs, the selection of the optimal solar panel location and various climatic conditions are considered to increase the energy production efficiency [20]. Once the location of the solar panel is selected, the panel is attached to the exterior wall of the building, and such an integration changes the building's envelope from an energy consumer to an energy producer. Solid-based active building envelopes are systems in which solar panels are integrated into the building roof and exterior walls. Currently, owing to the development of solar panel materials, solid-based active building envelopes are applied not only to opaque building shells but

also to transparent windows [21]. Semitransparent solar panels have been inserted into double-glazed windows to maximize the amount of renewable energy produced by building envelopes [22–24]. In particular, the active energy façade system installed on the southern vertical surface of a building façade maximizes the energy production efficiency through the attachment of solar panels to moveable louvers installed to control the solar influx [25,26]. Solar-panel-integrated louvers with fluid properties have the potential to be applied to the exterior of a building and used as a design element for creative façades and to produce renewable energy. Research related to the kinetic façade system installed on the exterior wall of a building aims to use technology to increase the energy efficiency of buildings through architectural design. Investigations have been conducted on kinetic façades based on geometric patterns inspired by traditional architectural designs in the Middle East [27]. In addition, researchers have developed a kinetic biomimetic system in which plants respond to light as a kinetic façade [28]. Glass façades of various colors with different geometric shapes and a kinetic façade abstracting a biomimetic system were developed on a building façade. These studies aimed to improve daylight performance within the building space using the developed kinetic façade. Daylight performance was measured in a virtual space via parametric simulations.

2.2. Parametric Design in Architecture

“Parameter”, the core of parametric systems applied to various fields today, has a broad meaning. The etymology of “parameter” is a combination of the ancient Greek words “para” and “metron,” where “para” means “besides, before, or instead of,” and “metron” means “measure.” According to ancient Greek etymology, “parameter” refers to a term that represents or determines another measure. Parametric design in the field of architecture was first introduced in 1971 as the concept of “relationships between measures” [29]. These parametric concepts were implemented as buildings in a virtual space using computer software.

Architectural parameters were used to draw conclusions based on the diverse variables necessary for the architectural design. In other words, the parameters in the field of architecture are characterized by a range of possible values rather than by obtaining a constant result, such as a mathematical formula. The advantage of parametric design is that it can produce various architectural design results by controlling several parameters [30]. Proposals of various architectural designs using this parameter system have the advantage of not only deriving creative designs but also judging the effectiveness of the design according to each parameter.

Parametric tools originated in SketchPad [31], a computer program developed by Ivan Sutherland in 1963. SketchPad, the first computer-aided system (CAD) program, is a pen equipped with a laser pointer [32]. It allows not only the creation of simple basic shapes, but also design changes through parametric equations. Additionally, as the parameters change, the shapes are recalculated, and design changes become possible. While early CAD systems simply digitized design concepts expressed on paper using basic logic, parametric design is currently evolving to present architectural concepts and new design perspectives, owing to the development of parametric software programs.

Parametric design has been applied in the architectural field since the early 1990s. Parametric modeling has significantly influenced the design process for architectural development and the establishment of new design concepts. Parametric design was established as a new architectural theory called “Parametricism” and began to be used as a concept to signify a new global architectural style beyond a simple design tool [33]. In particular, the digital revolution of the 20th century accelerated the application of parametric design in the architectural field.

Parametric design software have developed rapidly since the early 2000s. The most commercialized software in the architectural field today is Grasshopper, a plug-in program for Rhinoceros, and Dynamo, a plug-in program for Revit developed by Autodesk under the concept of building information modeling [34,35]. Designers use parametric design

software, and design is performed through the definition of an algorithm, which is an integrated system that combines diverse variables for architectural design. An algorithm is a system that solves a given problem using well-defined processes and basic unambiguous instructions [36]. When limited data are input into the algorithm, special results are obtained. Various algorithms have been built for optimal design, and the best method that satisfies the criteria for design decisions is determined by generating positive or negative results based on the input data.

2.3. Shading Structure

Shading structures are minimal architectural structures installed to avoid exposure to excessive sunlight. As an architectural structure, the shading structure has its origins in the velarium of the ancient Roman era. The velarium is a canvas-type folding system composed of ropes and masts, and a representative example is the one installed on the roof of the Colosseum in ancient Rome. The velarium installed on the roof of the Colosseum has the advantage of low installation costs because it uses minimal construction technology, provides shade to spectators, and simultaneously facilitates ventilation inside the Colosseum through the sloping roof [37]. Shading structures, which were developed for long-term outdoor activities (starting with the velarium), are still in good use. Shaded structures are installed on public streets in countries with hot climates. The awning installed at the top of a public street not only protects pedestrians from excessive solar radiation but also protects public spaces from dust and glare. Additionally, through material development, shading structures are responsible for the architectural research field of membrane architecture [38]. The flexibility of the materials that constitute the shading structure and the lightweight architectural structure that supports the flexibility of the materials not only play a functional role in blocking sunlight but are also used as an aesthetic element in architectural design. In particular, sunsails that make up sunshades are an important architectural element in that they can variably construct and control spaces and provide users with various spatial experiences depending on light, shadow, and internal temperature [39]. Shading structures, which have architectural functions and aesthetic potential, are widely used today in external spaces, stadium roofs, and shading designs on the exteriors of buildings.

From the perspective of building energy utilization, the sunsail-type shading structure is based on a passive energy system. However, current buildings must have active energy systems that produce a certain amount of renewable energy within the building itself. From this perspective, shading structures installed outdoors have the potential to utilize passive and active energy systems, because of the direct exposure of the surrounding environment to sunlight, the area of the structure, and the flexible nature of the structure.

3. Methodology

This study consisted of five stages. First, an architectural design was developed for the shading structure. The shading structure was designed to be variable and easy to install. The main architectural elements that constituted the shading structure were integrated solar panels with a solar-energy-based active design. It was assumed that the shaded structure was installed in an external space without shadow interference from surrounding structures. The purpose of installing a shading structure in an external space was to build a multipurpose architectural space to facilitate various outdoor activities and simultaneously utilize solar energy to increase the renewable energy production efficiency of the building. Second, the architectural design was implemented in a virtual space using a computer program. In this study, a shaded structure was designed using the Autodesk Revit 2020 software. The Revit software is a representative architectural design program that integrates various data from the architectural design process and digitally realizes all the stages from architectural planning and design to construction and operation, which are the final stages of construction [40]. Third, a parametric design was developed. The purpose of the parametric design was to build a solar-based active architectural design. Dynamo, Revit's plug-in software, was used to build algorithms for the parametric design

and perform the design according to the variables. Fourth, the active energy design of the shaded structure was simulated. The design simulation aimed to measure the amount of renewable energy generated by the shading structure. This study used Revit's plug-in software, the Insight program, to measure the amount of solar energy generated by the solar panels. Finally, the parametric design results were derived. The amount of renewable energy generated from the shading structure over one year and the overall appearance of the shading structure were evaluated (Figure 1).

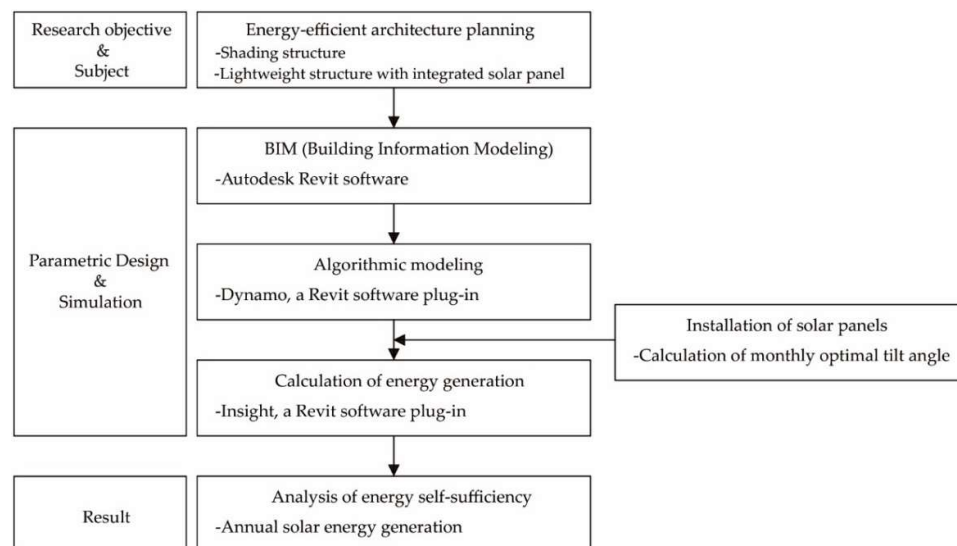

Figure 1. Flowchart of methodology.

4. Design

4.1. Arrangement of Solar-Panel-Integrated Modules That Form the Shading Structure

The shading structure was implemented using the Autodesk Revit 2020 program [41]. The module comprising the shading structure was an integrated solar panel and was 0.5 m wide and 0.7 m long. All the panels were placed facing south to ensure maximum sunlight exposure (Figure 2A). The module size was set based on the specifications of solar panels that are currently being produced. The solar panel selected for this study (Q. PEAK DUO XL-G10, 1 m wide and 2.1 m long) is used on building roofs [42]. To apply a solar panel to a shaded structure, the panel must be in the form of a small module. As the shading structure is easy to install and has a variable structure, the solar panels used on the roofs of buildings must be lightweight. By dividing the solar panels installed on the roof of the building selected for this study into six parts, a minimum unit shading structure module with a width of 0.5 m and a length of 0.7 m was obtained. The size of this single module was determined to ensure no panel loss after segmenting the existing large solar panels. The modules on the upper floor were placed at 1 m intervals up to a maximum height of 7 m. The modules were not placed up to 1 m above the ground to prevent damage to them from pedestrians, and they were placed up to 7 m, the height of two floors of a regular building, to create sufficient shade space on the ground floor. Additionally, the modules were arranged inclinedly at intervals of 0.75 m on the sides and 1 m on the top to prevent shadow interference between the modules (Figure 2B). In the plan, each module was arranged at intervals of 1 m on the side and 0.75 m at the top and bottom. A total of 57 unit modules were placed at a site with a width of 11 m and a length of 5 m (Figure 2C). An area of 55 m², including the empty space between the 57 solar modules, was created using the shading structure. The 55 m² area was planned to satisfy Korea's minimum installation standard for public open spaces of 45 m² [43]. Excluding the space between the 57 solar panels in the 55 m² area, a 45 m² external space was created for people to occupy under the shading structure. First, through the arrangement of this module, the energy production efficiency was maximized because there was no shadow interference between

the modules. Second, a small amount of sunlight entered the shade curtain through the gap between the modules; therefore, the inside of the shade cloth was not completely dark. The number of modules can be varied according to the size of the external space in which the shading structure is installed and the purpose of the shading structure.

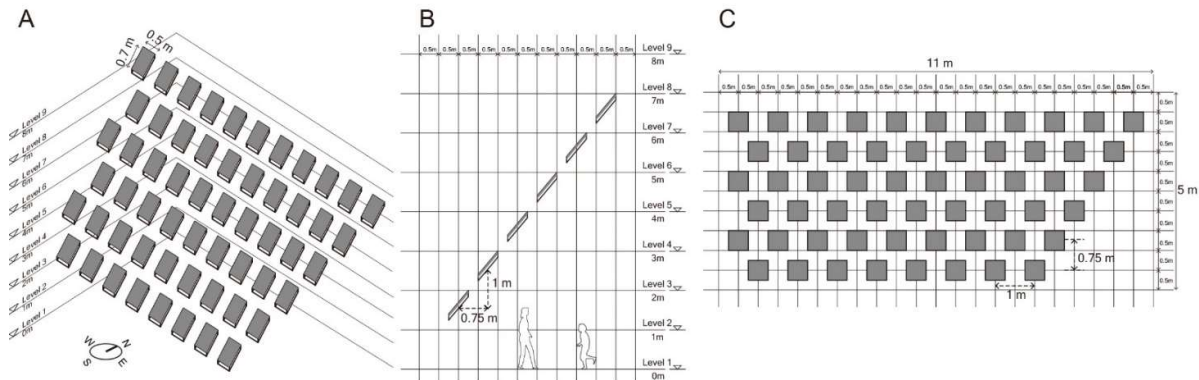

Figure 2. Layout of solar-panel-integrated modules. (A) Bird's-eye view of shading structure, (B) Cross-section of shading structure, (C) Layout of shading structure.

4.2. Flexible Shading Structure Plan for Energy Optimization

This study utilized solar panels for an active design that produces energy within the building itself and employed flexible solar modules to maximize the energy generation efficiency. In a flexible solar module, the installation angle of the solar panel changes to increase the energy generation efficiency according to the movement trajectory of the sun, which changes monthly during the year. These flexible solar panels can maximize energy generation compared with existing fixed solar panels. They have the potential to be applied to the exterior of buildings as a “kinetic façade” and be used as an important element of architectural design. The solar modules were installed according to the optimal tilt angle for each month to achieve the optimal energy generation. The monthly optimal tilt angle value is calculated using the Calabrò function (1) [44]. In Equation (1), β is the optimal tilt angle value, and a_1 and a_2 are coefficients derived from the solar declination value.

$$\beta = a_1 + a_2 \times \varphi \quad (1)$$

The monthly optimal tilt angle value (β) is derived from the coefficients a_1 and a_2 from January to December. The device supporting the solar module was designed to move 90° relative to the south-facing central axis of the panel. The solar modules were placed according to the optimal tilt angle for each month using a lightweight metal device that could move in response to sunlight. In each solar panel, PV cells, each with a thickness of 6 mm, were placed on top of a lightweight steel structure with a thickness of 1 mm. The solar panel had a rotating device installed at the bottom such that it could be moved according to the optimal tilt angle. The rotating device integrated with the solar panel was placed on thin aluminum tubes ($d = 1$ cm) (Figure 3). The total weight of a unit solar panel, including the lightweight steel structure, was approximately 0.5 kg. The total weight of the 57 solar panels that constituted the shading structure was expected to be 28.5 kg, and this weight was sufficiently supported by the tensile-supporting structure. In particular, the tensile-supporting structure of the thin aluminum tube was a flexible structural form that moved in response to wind action. This flexible structure is a structurally safe model in which the structure deforms without collapsing owing to external shock [45].

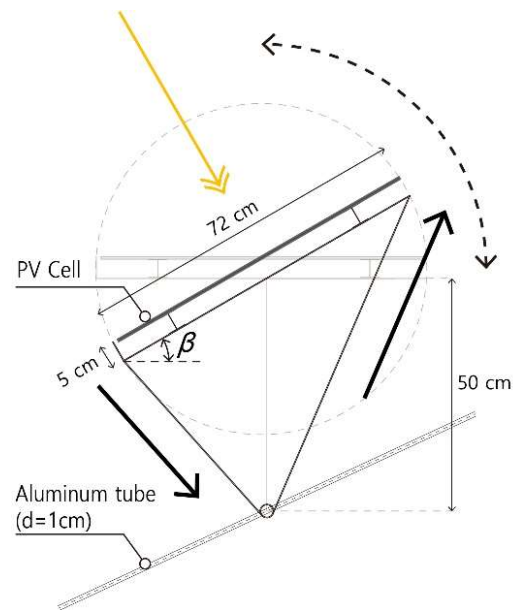

Figure 3. Principle of flexible solar-panel-integrated module.

The study was conducted assuming that the shading structure was installed in Seoul, the capital of Korea (37.5° N, 126.9° E). By substituting the latitude of Seoul ($\varphi = 37.5$) and the coefficients a_1 and a_2 from January to December into Equation (1), the optimal tilt angle values are derived (Table 1).

Table 1. Optimal tilt angle from January to December for Seoul (37.5° N, 126.9° E).

Month	Coefficients		Optimal Tilt Angle (Deg)
	a_1	a_2	β
January	31.33	0.68	56.8°
February	16.25	0.86	48.5°
March	6.80	0.84	38.3°
April	-6.07	0.87	26.6°
May	-14.95	0.87	17.7°
June	-19.27	0.87	13.4°
July	-15.65	0.83	15.5°
August	-4.23	0.75	23.9°
September	6.42	0.77	35.3°
October	15.84	0.83	47.0°
November	23.61	0.84	55.1°
December	30.56	0.76	59.1°

5. Parametric Modeling and Simulation

5.1. Building Algorithms for Parametric Modeling

The aforementioned shading structure implemented in a virtual space using the Revit software was composed of solar-panel-integrated modules of a certain size. In addition, the modules moved according to the optimal tilt angle every month to maximize the renewable energy generation. An energy simulation for the proposed shading structure was conducted using the size of the solar-panel-integrated module and the optimal tilt angle at which the module was installed as variables. Parametric modeling is the process of designing through the definition of an algorithm that integrates these variables. This study implemented parametric modeling using Dynamo [46], a plug-in program for the Revit software used for the implementation of the shading structure.

Dynamo is a programming language that allows the development of Revit programs. This tool can develop functions based on Revit to suit the user's environment [47]. Through

the language system built with Dynamo, simple repetitive tasks owing to various environmental changes are shortened, and large amounts of input data are easily processed. In addition, Dynamo is a visual graphic programming tool that makes it easy to understand the flow of parametric modeling, because it is a programming language that connects nodes for executing commands and nodes for inputting variables. This parametric modeling process involves building an algorithm. The schematic of the algorithm for this study is described as follows. First, the solar panel is selected from among the various architectural elements that constitute the shading structure. A specific solar panel module can be selected from several solar panels. Second, the size of the solar panel module is determined. Finally, the solar panel module is placed at the desired installation angle (Figure 4).

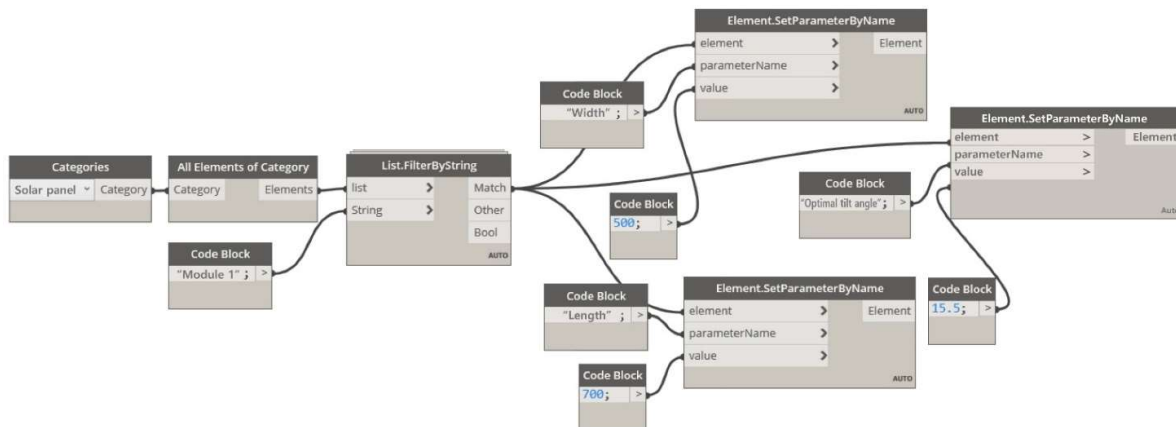

Figure 4. Schematic of the algorithm, with the width set to 500 mm and the length set to 700 mm for solar panel “Module 1” and an optimal tilt angle of 15.5° given as input.

5.2. Simulation for Solar Energy Generation

The simulation for renewable energy generation was conducted using the Revit plugin, the Insight program [48]. The Insight program was developed to simulate solar energy generation in buildings using Revit. The input variables for running the Insight program include information about the site where the building will be constructed. When the name of a city is entered, the program automatically recognizes its latitude and longitude. Second, a solar panel attached to a building was selected for the simulation. We could select the type of solar panel to be installed on the exterior wall, and we could also select all or a few solar panels. Third, the simulation period was set. Solar panel modules were placed according to the monthly optimal tilt angle from January to December 2023 derived using the Calabrò function in Section 4.2. Subsequently, a solar energy simulation was conducted by setting sunrise and sunset times from 6 a.m. to 8 p.m. (Figure 5).

Table 2 presents the amount of energy generated from the 57 solar panel modules (total panel area, 20 m²) that constitute the shading structure. Based on the energy simulations, the months with the highest and lowest solar energy production were June and December, respectively. In June, a total of 3474 kWh·month^{−1} was generated from solar panels installed at an optimal tilt angle of 13.4°. On the other hand, in December, a total of 1963 kWh·month^{−1} was generated from solar panels installed at an optimal tilt angle of 59.1°. The total amount of energy generated from the solar panels during the year from January to December 2023 was 31,570 kWh·year^{−1}.

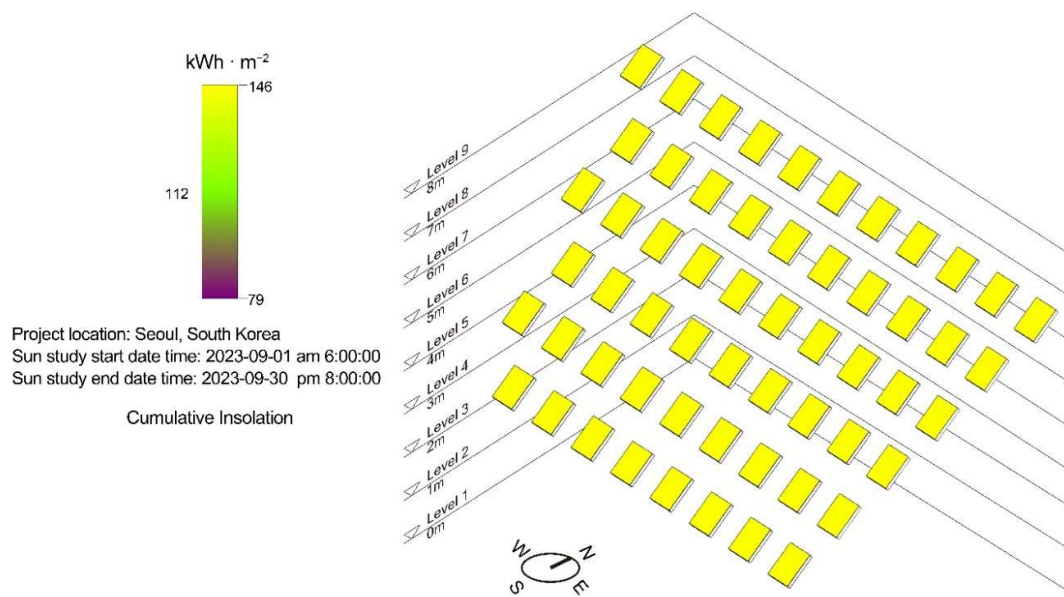

Figure 5. Solar panel module simulation generated by entering the optimal tilt angle of 35.3° corresponding to September 2023 into the Insight software.

Table 2. Solar energy generated according to optimal tilt angle and fixed optimal tilt angle (50°) from January to December.

Month	Total Area of Solar Modules	Optimal Tilt Angle	Energy Generation	Fixed Optimal Tilt Angle	Energy Generation
	m ⁻²	β	kWh·Month ⁻¹	β	kWh·Month ⁻¹
January	20	56.8°	2112	50°	2023
February	20	48.5°	2442	50°	2434
March	20	38.3°	3169	50°	3162
April	20	26.6°	2654	50°	2505
May	20	17.7°	3173	50°	2750
June	20	13.4°	3474	50°	2780
July	20	15.5°	1979	50°	1669
August	20	23.9°	2877	50°	2622
September	20	35.3°	2899	50°	2846
October	20	47.0°	2713	50°	2702
November	20	55.1°	2115	50°	2090
December	20	59.1°	1963	50°	1907
Total energy generation			31,570 kWh·year ⁻¹	29,490 kWh·year ⁻¹	

6. Results and Discussion

This study aimed to conduct empirical research to increase energy independence in the field of architecture. A shading structure composed of solar panel modules was selected as the research subject because, first, the shading structure itself is light and can be easily installed in an external space. As the structure is easy to install, various shading structure designs that utilize natural environments, such as trees, can be proposed. In addition, solar panels of various colors created through advancements in solar panel materials have the potential to be used as creative design elements for shaded structures (Figure 6). Second, the shading structure is directly exposed to sunlight; therefore, it is the optimal architecture to apply an active energy design that produces renewable energy from sunlight.

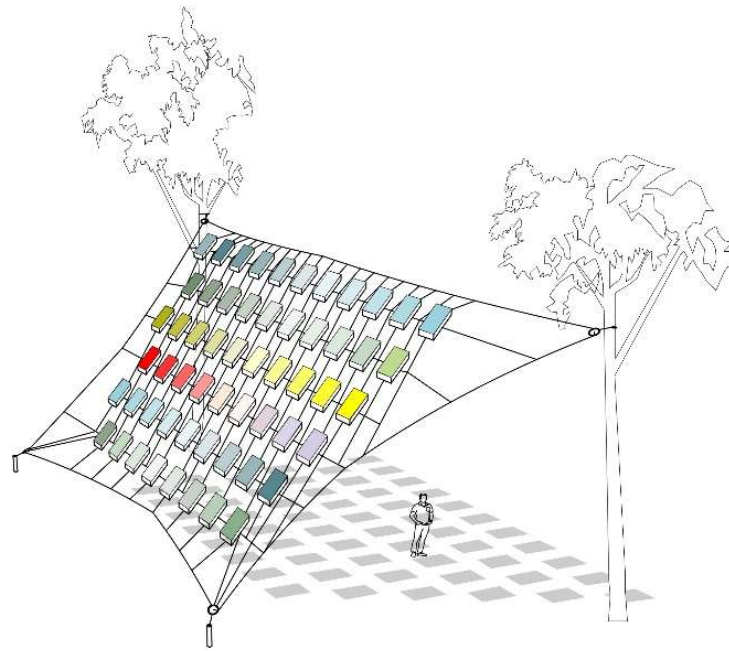

Figure 6. Virtual image of a shading structure with colored solar panels.

The shaded structure was constructed using a parametric design process. Parametric design is a process wherein a design is completed by inputting limited data into an algorithm built by a designer. Parametric design is evolving with the development of various software programs. In this study, a shading structure was implemented in a virtual space using Autodesk Revit. The Revit program is a preliminary step in applying parametric design and ensures that all the elements that constitute a building are implemented in a three-dimensional space. After the shading structure was built using the Revit program, an algorithm for the parametric design was built using Dynamo, Revit's plug-in software. The Dynamo algorithm was designed with the inputs of the size and installation angle of the solar panel module to be applied to the shading structure. A parametric design was conducted by inputting the optimal tilt angle information from January to December for 57 solar panel modules with a width of 0.5 m and a length of 0.7 m. After the physical form of the shading structure was determined using the Dynamo algorithm, an energy simulation was performed using the Revit plug-in software, the Insight program. The Insight program produces solar-based renewable energy upon inputting the location information of the shading structure and the period for energy simulation. In this study, an energy simulation was conducted for one year, from January to December 2023, assuming Seoul to be the location where the shading structure will be installed. Consequently, the energy generation was the highest in June ($3474 \text{ kWh}\cdot\text{month}^{-1}$), and the lowest in December ($1963 \text{ kWh}\cdot\text{month}^{-1}$). The total energy produced through the solar panels in 2023 was $31,570 \text{ kWh}\cdot\text{year}^{-1}$. Assuming that LED street lights ($100 \text{ W}\cdot\text{h}^{-1}$) installed in outdoor spaces operate for 12 h every day, the amount of generated energy ($31,570 \text{ kWh}\cdot\text{year}^{-1}$) derived from this study is sufficient to supply power to 72 LED street lights. These results demonstrate that parametric design in the architectural field is highly efficient in terms of construction and renewable energy generation.

As an empirical study related to kinetic façades, a building with a parametric design applied to the façade was completed in Germany in 2020. The optimal tilt angle for optimizing solar power generation was derived through a parametric simulation, and solar modules were placed at different angles on the south, southwest, and west sides of the building. As of 2022, the total renewable energy generated from building façades was equivalent to 14% of the total building energy consumed [49]. Solar panels at different an-

gles were installed on the three building façades using the kinetic façade concept, increasing the energy independence of the building.

The shading structure based on kinetic solar panels, whose positions change every month, as proposed in this study, can increase energy generation compared to solar panels fixed at optimal tilt angles. The generated renewable energy not only supplies power inside the building but can also power a number of external streetlights around the shading structure.

7. Conclusions

Since the onset of the COVID-19 pandemic, various external activities have been undertaken. This study was conducted with the objective of planning architectural spaces that serve as rest areas for various outdoor activities and increase the energy independence of architecture. A shading structure was used as the research object to provide the resting space necessary for outdoor activities, and an integrated solar panel module was used as the main structure of the shading structure. The novelty of the structure proposed herein is that, rather than being passive, where existing solar panels are fixed and installed on the roof or façade of a building, this structure was designed to move actively according to the optimal tilt angle for optimal solar energy generation every month. The advantages of these “kinetic solar panels” are, first, that renewable energy generation increases compared with existing fixed solar panels. When installing fixed solar panels in Seoul, the subject of this study, the optimal solar panel angle was 50° [50]. When the shading structure proposed herein was installed at a fixed angle of 50° and energy simulation was performed using the Insight software for one year in 2023, a total of $29,490 \text{ kWh}\cdot\text{year}^{-1}$ was derived (Table 2). The energy generation of $29,490 \text{ kWh}\cdot\text{year}^{-1}$ from solar panels fixed at 50° is equivalent to 93% of the energy ($31,570 \text{ kWh}\cdot\text{year}^{-1}$) generated by the kinetic solar panels proposed in this study. Second, by using moving solar panels, the scale and shape of the shading structure can be varied by varying the size and combination of various panel modules. Ultimately, the kinetic solar-panel-based shading structure proposed herein can increase energy generation compared with fixed solar panels and supply power to several external streetlights around the shading structure. Additionally, in terms of design, kinetic solar panels can be applied not only to simple lightweight structures, such as shading structures, but also to the exteriors of various buildings, and can be applied as an important element of architectural design.

The proposed kinetic solar panel was designed in a virtual space. Assuming that a shaded structure is built in a real space, this study has the limitation of not having a specific plan regarding the mechanism of the device for installing solar panels on the structure. Future research will aim to develop a solar panel system that moves independently according to the monthly optimal tilt angle. In particular, analyzing the power consumption required to move solar panels is an important research topic that determines the energy efficiency of kinetic solar panels. This study has the potential to initiate new convergence research through a collaboration between computer and electrical energy engineering for the design of kinetic solar panels, focusing on the field of architectural design.

Funding: This study was supported by a National Research Foundation of Korea (NRF) grant funded by the Korean Government, Ministry of Science, and ICT (MSIT) (No. 2022R1F1A1065442).

Institutional Review Board Statement: Not applicable.

Informed Consent Statement: Not applicable.

Data Availability Statement: The data presented in this study are available in the article. Further inquiries for the data presented in this study are available on request from the corresponding author.

Conflicts of Interest: The author declares no conflict of interest.

References

1. International Energy Agency. Final Energy Consumption of Buildings Relative to Other Sectors. 2022. Available online: <https://www.iea.org/data-and-statistics/charts/final-energy-consumption-of-buildings-relative-to-other-sectors-2022> (accessed on 11 August 2023).
2. Hu, S.; Zhou, X.; Yan, D.; Guo, F.; Hong, T.; Jiang, Y. A systematic review of building energy sufficiency towards energy and climate targets. *Renew. Sustain. Energy Rev.* **2023**, *181*, 113316. [[CrossRef](#)]
3. Park, D.J.; Yu, K.H.; Yoon, Y.S.; Kim, K.H.; Kim, S.S. Analysis of a building energy efficiency certification system in Korea. *Sustainability* **2015**, *7*, 16086–16107. [[CrossRef](#)]
4. Ma, H.; Zhou, W.; Lu, X.; Ding, Z.; Cao, Y. Application of low cost active and passive energy saving technologies in an ultra-low energy consumption building. *Energy Procedia* **2016**, *88*, 807–813. [[CrossRef](#)]
5. de Gracia, A.; Navarro, L.; Coma, J.; Serrano, S.; Román, J.; Pérez, G.; Cabeza, L.F. Experimental set-up for testing active and passive systems for energy savings in buildings—lessons learnt. *Renew. Sustain. Energy Rev.* **2018**, *82*, 1014–1026. [[CrossRef](#)]
6. Omrany, H.; Ghaffarianhoseini, A.; Ghaffarianhoseini, A.; Raahemifar, K.; Tookey, J. Application of passive wall systems for improving the energy efficiency in buildings: A comprehensive review. *Renew. Sustain. Energy Rev.* **2016**, *62*, 1252–1269. [[CrossRef](#)]
7. Benaddi, F.Z.; Boukhattem, L.; Ait Nouh, F.; Cesar Tabares-Velasco, P.; Benhamou, B. Energy-saving potential assessment of a classroom building envelope through sensitivity analysis and multi-objective optimization under different climate types. *Build. Serv. Eng. Res. Technol.* **2023**, *44*, 309–332. [[CrossRef](#)]
8. Wu, Z.; Shi, X.; Fang, F.; Wen, G.; Mi, Y. Co-optimization of building energy systems with renewable generations combining active and passive energy-saving. *Appl. Energy* **2023**, *351*, 121514. [[CrossRef](#)]
9. Shukla, A.K.; Yadav, A.K.; Prakash, R. Active and passive methods for cooling load reduction in a tropical building: A case study. *Energy Conv. Manag.* **2023**, *293*, 117490. [[CrossRef](#)]
10. Yu, S.; Liu, X.; Yang, J.; Han, F.; Wei, J. The optimization research on the coupled of active and passive energy supplying in public institutions in China. *Energy Built Environ.* **2024**, *5*, 288–299. [[CrossRef](#)]
11. Díaz-López, C.; Serrano-Jiménez, A.; Lizana, J.; Lopez-Garcia, E.; Molina-Huelva, M.; Barrios-Padura, A. Passive action strategies in schools: A scientific mapping towards eco-efficiency in educational buildings. *J. Build. Eng.* **2022**, *45*, 103598. [[CrossRef](#)]
12. Taherian, H.; Peters, R.W. Advanced Active and Passive Methods in Residential Energy Efficiency. *Energies* **2023**, *16*, 3905. [[CrossRef](#)]
13. Almeahmadi, F.A.; Alqaed, S.; Mustafa, J.; Jamil, B.; Sharifpur, M.; Cheraghian, G. Combining an active method and a passive method in cooling lithium-ion batteries and using the generated heat in heating a residential unit. *J. Energy Storage* **2022**, *49*, 104181. [[CrossRef](#)]
14. McEvoy, A.; Markvart, T.; Castaner, L. *Practical Handbook of Photovoltaics*, 2nd ed.; Academic Press: Cambridge, MA, USA, 2011; p. 15.
15. Marques Lameirinhas, R.A.; Torres, J.P.N.; de Melo Cunha, J.P. A photovoltaic technology review: History, fundamentals and applications. *Energies* **2022**, *15*, 1823. [[CrossRef](#)]
16. Barber, D.A. *A House in the Sun: Modern Architecture and Solar Energy in the Cold War*; Oxford University Press: Oxford, UK, 2016; p. 53.
17. Kasaeian, A.; Nouri, G.; Ranjbaran, P.; Wen, D. Solar collectors and photovoltaics as combined heat and power systems: A critical review. *Energy Conv. Manag.* **2018**, *156*, 688–705. [[CrossRef](#)]
18. Nayak, P.K.; Mahesh, S.; Snaith, H.J.; Cahen, D. Photovoltaic solar cell technologies: Analysing the state of the art. *Nat. Rev. Mater.* **2019**, *4*, 269–285. [[CrossRef](#)]
19. Al Dakheel, J.; Tabet Aoul, K. Building Applications, opportunities and challenges of active shading systems: A state-of-the-art review. *Energies* **2017**, *10*, 1672. [[CrossRef](#)]
20. Unguresan, P.V.; Porumb, R.A.; Petreus, D.; Pocola, A.G.; Pop, O.G.; Balan, M.C. Orientation of facades for active solar energy applications in different climatic conditions. *J. Energy Eng.* **2017**, *143*, 04017059. [[CrossRef](#)]
21. Luo, Y.; Zhang, L.; Bozlar, M.; Liu, Z.; Guo, H.; Meggers, F. Active building envelope systems toward renewable and sustainable energy. *Renew. Sustain. Energy Rev.* **2019**, *104*, 470–491. [[CrossRef](#)]
22. Musameh, H.; Alrashidi, H.; Al-Neami, F.; Issa, W. Energy performance analytical review of semi-transparent photovoltaics glazing in the United Kingdom. *J. Build. Eng.* **2022**, *54*, 104686. [[CrossRef](#)]
23. Li, D.H.; Aghimien, E.I.; Alshaibani, K. An Analysis of Real-Time Measured Solar Radiation and Daylight and Its Energy Implications for Semi-Transparent Building-Integrated Photovoltaic Façades. *Buildings* **2023**, *13*, 386. [[CrossRef](#)]
24. Ioannidis, Z.; Rounis, E.-D.; Athienitis, A.; Stathopoulos, T. Double skin façade integrating semi-transparent photovoltaics: Experimental study on forced convection and heat recovery. *Appl. Energy* **2020**, *278*, 115647. [[CrossRef](#)]
25. Haselsteiner, E. *Robust Architecture. Low Tech Design*; DETAIL: Munich, Germany, 2023; pp. 68–71.
26. Vassiliades, C.; Agathokleous, R.; Barone, G.; Forzano, C.; Giuzio, G.; Palombo, A.; Buonomano, A.; Kalogirou, S. Building integration of active solar energy systems: A review of geometrical and architectural characteristics. *Renew. Sustain. Energy Rev.* **2022**, *164*, 112482. [[CrossRef](#)]
27. Hosseini, S.M.; Mohammadi, M.; Schröder, T.; Guerra-Santin, O. Integrating interactive kinetic façade design with colored glass to improve daylight performance based on occupants' position. *J. Build. Eng.* **2020**, *31*, 101404. [[CrossRef](#)]

28. Sommese, F.; Hosseini, S.M.; Badarnah, L.; Capozzi, F.; Giordano, S.; Ambrogi, V.; Ausiello, G. Light-responsive kinetic façade system inspired by the Gazania flower: A biomimetic approach in parametric design for daylighting. *Build. Environ.* **2024**, *247*, 111052. [CrossRef]
29. Rostagni, C. *Luigi Moretti 1907–1973*; Mondadori Electa: Milano, Italy, 2008; p. 18.
30. Jabi, W. *Parametric Design for Architecture*; Hachette: London, UK, 2013; pp. 9–11.
31. Sketchpad Software. Available online: <https://sketch.io/sketchpad/> (accessed on 22 January 2024).
32. Sutherland, I.E. Sketchpad: A man-machine graphical communication system. In Proceedings of the Spring Joint Computer Conference, Cambridge, UK, 21–23 May 1963.
33. Schumacher, P. Parametricism: A new global style for architecture and urban design. *Archit. Des.* **2009**, *79*, 14–23. [CrossRef]
34. Assai, R. Parametric Design, A Historical and Theoretical Overview. In Proceedings of the International Conference on Emerging Technologies in Architectural Design (ICETAD2019), Toronto, Canada, 17–18 October 2019.
35. Eltaweel, A.; Yuehong, S. Parametric design and daylighting: A literature review. *Renew. Sustain. Energy Rev.* **2017**, *73*, 1086–1103. [CrossRef]
36. Di Paola, F.; Mercurio, A. *Parametric Experiments in Architecture*; Springer: Cham, Switzerland, 2023; p. 3.
37. Ramzy, N. Sustainable spaces with psychological values: Historical architecture as reference book for biomimetic models with biophilic qualities. *ArchNet-IJAR* **2015**, *9*, 248–267. [CrossRef]
38. Sackmann, E. Biological membranes architecture and function. *Struct. Dyn. Membr.* **1995**, *1*, 1–63.
39. Carl, T.; Stepper, F.; Schein, M. Solar Spline. *Comput. A Better Tomorrow* **2018**, *1*, 149.
40. Smith, P. BIM implementation—global strategies. *Procedia Eng.* **2014**, *85*, 482–492. [CrossRef]
41. Revit Software. Available online: <https://www.autodesk.com/products/revit/overview?plc=RVT&term=1-YEAR&support=ADVANCED&quantity=1> (accessed on 14 April 2023).
42. Hanwha Q CELLS'. Available online: <https://qcells.com/kr/get-started/complete-energy-solution/solar-panel-detail?srPnId=SRPL211201071943005> (accessed on 28 October 2023).
43. Seoul Metropolitan Government. Available online: <https://news.seoul.go.kr/citybuild/archives/511445> (accessed on 9 January 2024).
44. Calabrò, E. An algorithm to determine the optimum tilt angle of a solar panel from global horizontal solar radiation. *J. Renew. Energy* **2013**, *2013*, 307547. [CrossRef]
45. Georgantzia, E.; Gkantou, M.; Kamaris, G.S. Aluminium alloys as structural material: A review of research. *Eng. Struct.* **2021**, *227*, 111372. [CrossRef]
46. Dynamo Software. Available online: https://primer.dynamobim.org/en/02_Hello-Dynamo/2-1_launching_dynamo.html (accessed on 20 April 2023).
47. Thabet, W.; Lucas, J.; Srinivasan, S. Linking life cycle BIM data to a facility management system using Revit Dynamo. *Organ. Technol. Manag. Constr.* **2022**, *14*, 2539–2558. [CrossRef]
48. Insight Software. Available online: <https://www.autodesk.com/products/insight/overview> (accessed on 2 May 2023).
49. Hofmeister, S. *Detail, Circular Economy*; Detail Business Information GmbH: München, Germany, 2022; p. 22.
50. Yoo, S.H. Simulation for an optimal application of BIPV through parameter variation. *Sol. Energy* **2011**, *85*, 1291–1301. [CrossRef]

Disclaimer/Publisher’s Note: The statements, opinions and data contained in all publications are solely those of the individual author(s) and contributor(s) and not of MDPI and/or the editor(s). MDPI and/or the editor(s) disclaim responsibility for any injury to people or property resulting from any ideas, methods, instructions or products referred to in the content.