

Recycling improves soil fertility management in smallholdings in Tanzania

A. Krause, V. S. Rotter

Correspondence to: Ariane Krause (krause@ztg.tu-berlin.de)

Table Content

Supplementary Figures	2
Supplementary Tables	6
Preliminary Remark to the appendix for the modelling approach	14
Supplementary 1. General information	14
Supplementary.1.1. Basic description of the agroecosystem analysed	14
Supplementary.1.2. Definition of scenarios defined	15
Supplementary.1.3. Method applied and basic organisation of computational work	17
Supplementary.1.4. Assumptions and simplifications in the AES-model	20
Supplementary.2. Specific equations applied for modelling	24
Supplementary.2.1. Output flows of the natural balance	24
Supplementary.2.2. Input flows of the natural balance	24
Supplementary.2.3. Output flows of the partial balance	24
I. Biomass production	24
II. Nutrient uptake of crops	26
III. Gaseous emissions from fertiliser applications	26
IV. Gaseous emissions from burning agricultural residues	26
Supplementary.2.4. Input flows of the partial balance	27
I. Organic input: carpeting and mulching	27
II. Organic input: biogas slurry	28
III. Organic input: standard compost	29
IV. Organic input: CaSa-compost	29
V. Mineral input: urine application	29
Supplementary.2.5. Synthesis: calculating the partial balances and the full soil nutrient balances	30
Supplementary.2.6. Composting process	31
I. Standard composting	31
II. CaSa-composting	32
Supplementary.3. Assessment of emissions to the environment	33
Supplementary.3.1. Assessment of greenhouse gas emissions to the atmosphere	33
Supplementary.3.2. Assessment of nutrient emissions to the hydrosphere	34
Supplementary.4. Short Discussion	34
Supplementary.5. Data collection of material and process values	35
Supplementary.6. Terminology	41
List of References	41
List of Abbreviations	45

FIGURES

Impressions of the main land-used types of cropping systems in Karagwe, TZ.



Fig. S.1: Example of a *shamba*, the agricultural land surrounding farming houses, also called ‘banana-based home garden’, used for inter-cropping of perennial crops like fruit, banana, and coffee trees and annual crops including beans, cassava, African egg-plant, etc. (Photo taken by A. Krause, 2010).



Fig. S.2: Example of a *msiri*, former grassland used for the cultivation of annual crops including maize, beans, millet, and vegetables like tomatoes, cabbage, onion, etc. (Photo taken by A. Krause, 2010).

Modelling approach of the system analysis applied to smallholder farming in Karagwe, TZ

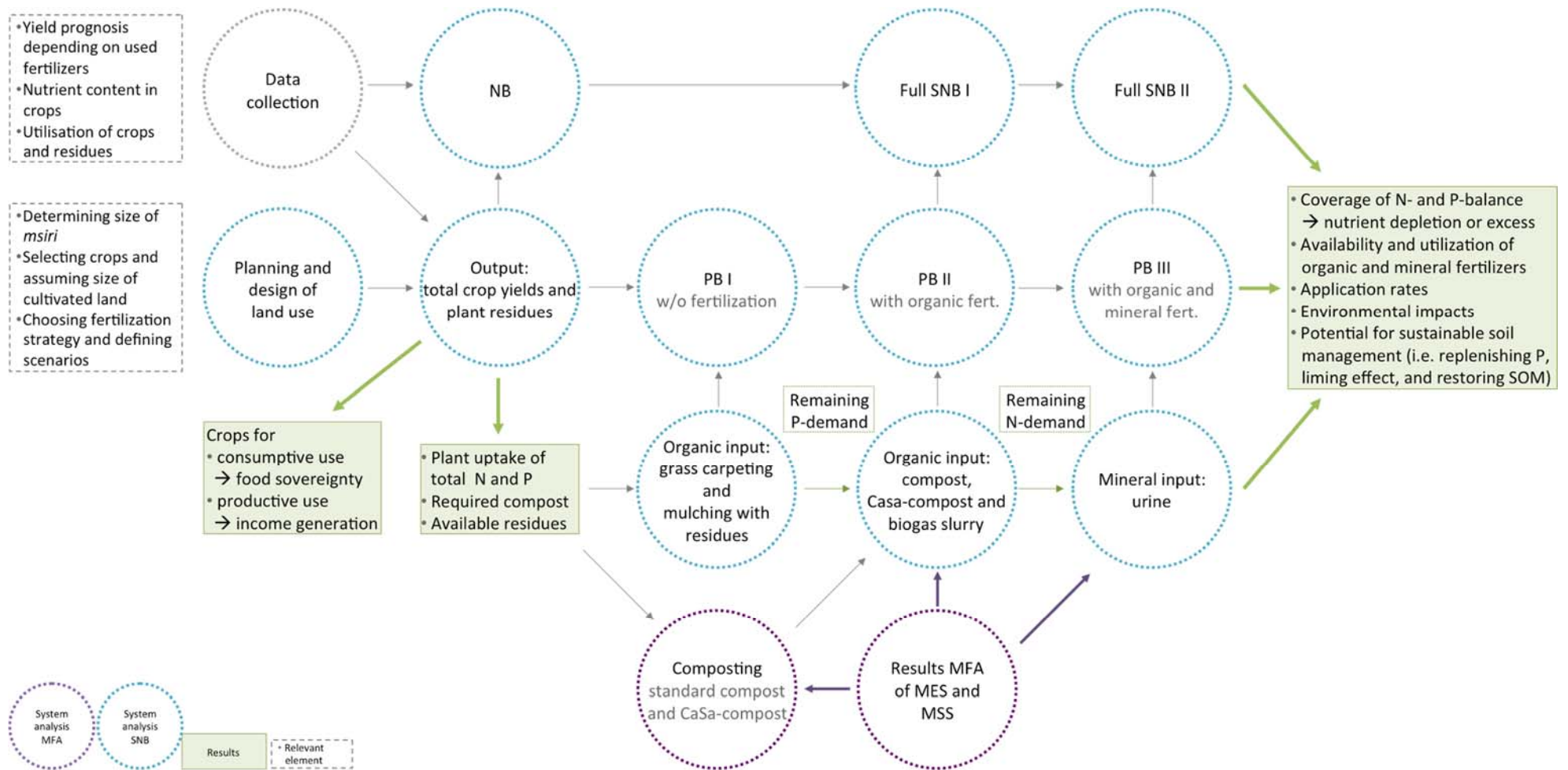

Fig. S.3: Proceeding of the applied system analysis combining the material flow analysis (MFA) with the soil nutrient balance (SNB) for an annual intercropping system in Karagwe, TZ

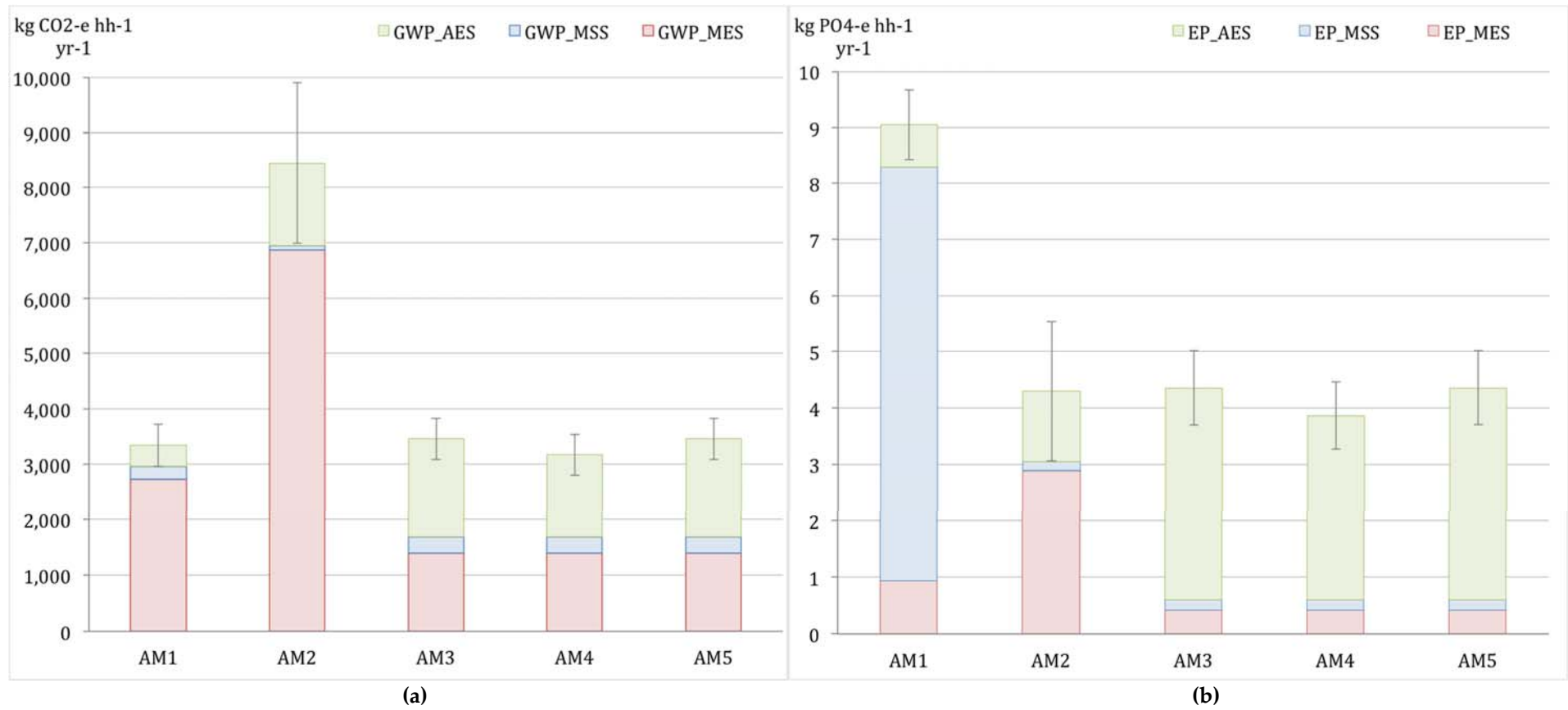

Fig. S.4: Integrated environmental impacts of the micro energy systems (MES/red), the micro sanitation system (MSS/blue), and the agroecosystem AES/green) for the global warming potential (a) and the eutrophication potential (b). Plot data provided in Tables S.15 (Fig. S.4a) and S.16 (Fig. S.4b). Scenarios defined in Table 1 of the main article.

Modelling the SNB: evaluation of data

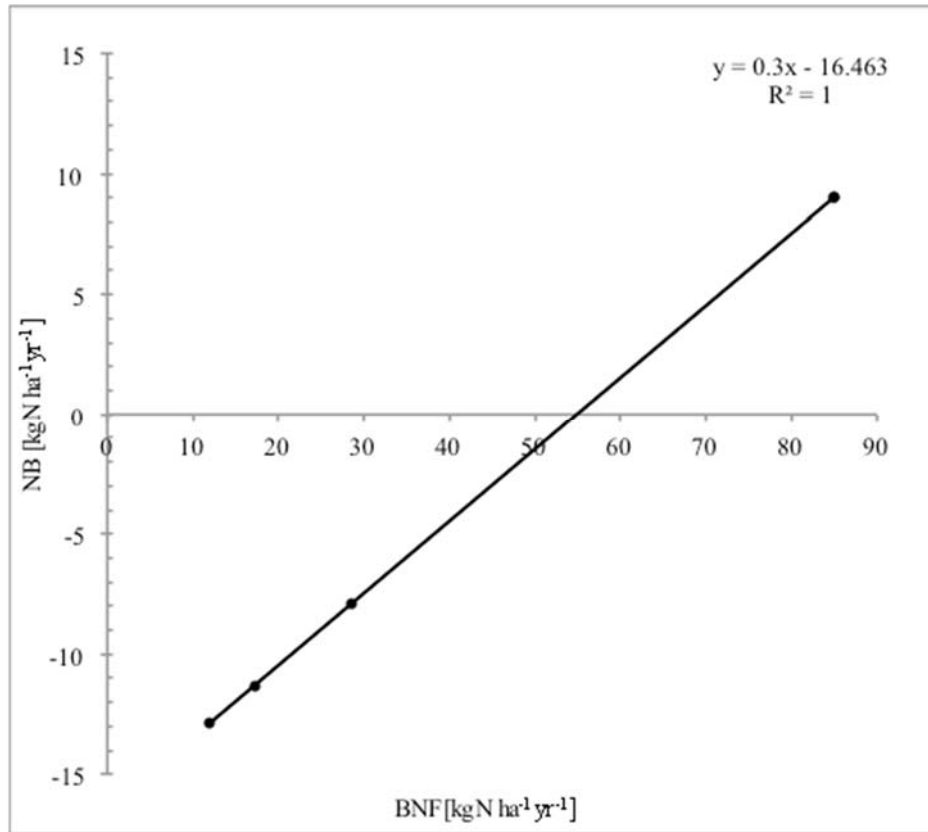

Fig. S.5: Regression analysis for estimating the relationships between the N-flows in the natural balance (NB) and the biological nitrogen fixation (BNF) for all of the five analysed scenarios; values are displayed in kg of N per hectare and year. Plot data provided in Tables S.17

TABLES

Summary of data describing the agroecosystem analysed

Table S.1: Production of main crops in Kagera region and Karagwe district based on the national sample census of agriculture 2007/2008 (Tanzania, 2012).









	Meaning of production in Kagera region	Meaning of production in Karagwe district	Total area planted in Karagwe [ha]	Number of household involved in crop production in Karagwe	Area planted per growing household in Karagwe [ha hh ⁻¹]	Average yield (in FM) in Karagwe [t ha ⁻¹]
Permanent crops:						
Banana	Main crop with about 50 % of the area used for permanent crops being cultivated with banana.	Largest area planted with banana within Kagera.	44,800	88,700	0.50	5.0
Coffee	Main cash crop.	Strongest coffee producing district in the region in terms of cultivated land and total harvest.	19,000	65,600	0.29	0.9
Annual crops – cereals and pulses/legumes:						
Beans	Dominant annual crop; production decreased by ~7.5 % compared to census 2003 (based on total area planted).	~37 % of the total area used for cultivation of annual crops and ~98 % of total production of pulses.	41,900	121,500	0.34	1.0
Maize	Second dominant annual crop; production of maize increased by ~20 % compared to census 2003 (based on the annual production).	~27 % of the total area used for cultivation of annual crops and ~77 % of the total land planted with cereal crops.	17,200	82,900	0.21	1.2
Annual crops – vegetables:						
Cabbage	Second important vegetable (after tomatoes).	Second largest production area in Kagera with ~20 % of land used for cabbage production in Kagera.	204	1,600	0.13	7.6
Onion	7 th important vegetable.	Strongest producer in Kagera with nearly ~44 % of the land planted with onion in Kagera region.	75	700	0.11	2.8

Abbreviations: FM: fresh matter; hh: household.

Other important crops: permanent crops: mango, orange sugar cane; annual cereal crops: paddy (not in Karagwe), sorghum (especially in Karagwe), millet; annual root and tuber crops: cassava, sweet potatoes; annual oil seed crops: mainly groundnuts; minor soy beans and sunflower; annual vegetable crops: tomatoes, bitter aubergine, amaranth (spinach), chillies, pumpkins, okra, ginger; annual cash crops: tobacco and cotton are grown in Kagera, however not in Karagwe.

Summary of the technologies analysed

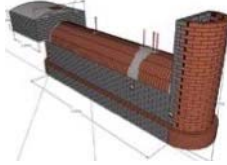
Table S.2: Pictures and short description of the analysed cooking alternatives that are locally available in Karagwe, TZ.
Table adopted from Krause and Rotter, 2017; Table S26, Supplementary 1).

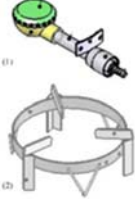

Three-stone-fire	Sawdust gasifier	Microgasifier stove	Top-Lit UpDraft	Biogas digester	Biogas system
 	 	 	 	 	<p>1-combustor, 2-pot stand</p>
<p>Easily prepared on-site. Continuous firing possible.</p> <p>costs: <i>none</i></p> <p>Residue: ash</p>	<p>This advanced sawdust gasifier was developed in Karagwe by the local NGO CHEMA in cooperation with EWB. Production takes place at CHEMA local workshop. Distribution on local markets started 2017.</p> <p>31,000 TZS ≈12.50 € (selling price)</p>	<p>TLUD is an open source design. TLUD stoves are produced and distributed by a local NGO.</p> <p>29,000 TZS ≈12 € (selling price)</p> <p>biochar and ash</p>	<p>The BiogaST-digester was developed by the local NGO MAVNO in cooperation with EWB; the design follows the concept of a plug-flow digester.</p> <p>≈ 3,000,000 TZS ≈1,200 € (material+labour costs)</p> <p>Biogas slurry</p>	<p>CAMARTEC is Tanzanian producer and distributor of biogas burner of the design "Lotus 2".</p> <p>60,000 TZS ≈24 € (selling price)</p>	

Non-common abbreviations: CAMARTEC: Centre for Agricultural Mechanisation and Rural Technology; CHEMA: Programme for Community Habitat Environmental Management; EWB: Engineers without borders; MAVUNO: Swahili for "harvest", name of a farmers' organization; NA: not analysed; TLUD: Top-Lit UpDraft

Sources of pictures: Three-stone fire: photo: <http://www.lowtechmagazine.com/2014/06/thermal-efficiency-cooking-stoves.html>; drawing: <http://www.nzdl.org/gsd/collect/envl/archives/HASH0165/064374a4.dir/p087a.gif>; Microgasifier stoves: <http://www.ingenieure-ohne-grenzen.org/de/Regionalgruppen/Berlin/Projekte/Effizientes-Kochen-in-Tansania-EfKoiTa>; photographs by D. Fröhlich; Biogas digester: <http://www.ingenieure-ohne-grenzen.org/de/Projekte/TZA-I0G26/BiogaST-Biogas-Support-for-Tanzania/BiogaST-Forschung-und-Entwicklung-2008-2014>; Biogas burner: Schrecker (2014)

Table S.3: Pictures and short description of the analysed sanitation alternatives that are locally available in Karagwe, TZ.

Table adopted from Krause and Rotter, (2017).

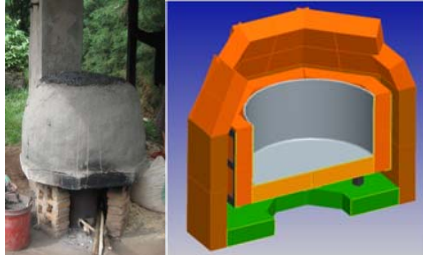
Pit Latrine	EcoSan: UDDT only	CaSa: UDDT and sanitation oven
		
<p>The substructure of the latrine toilet can be built from locally available material. Part of the grey water is disposed into the toilet, too. Often, ashes are added to the pit to avoid bad odours.</p> <p>The pit latrine is an accumulation system, i.e. material is constantly covered by new material. The pit is usually unlined so that the liquid phase soaks away and effluent infiltrates the surrounding soil. The solid phase remains in the pit and is slowly decomposed in predominantly anaerobic conditions.</p>	<p>The UDDT is used for the separate collection and storage of urine and faeces. Toilets can be designed for sitting or squatting. After defecation, so-called “dry material” is added to enhance the drying of faeces and to reduce smelling. Receptacles for collection of excreta are placed in the substructure under the toilet slab. Wastewater from anal cleansing is directed to a soil filter, which can be designed, for example, as a flowerbed.</p> <p>Solids are collected in a chamber and primarily composted inside the toilet until the chamber is full (i.e. several weeks to months). Subsequently, it can be used in the <i>shamba</i>¹, e.g. by putting the matter on rotation basis into a planting hole for a tree or cutting of a banana plant. This practice is locally called <i>omushote</i>.</p>	<p>Solids are collected in pots. If full, the pot is transported (with handles or a trolley) into a loam oven. Here, the matter is thermally sanitised via pasteurisation to inactivate pathogens that may be present in faeces. The loam oven is fired with a microgasifier. Afterwards, solids are composted with biochar (i.e. residues from sanitation process and/or cooking) and other organic residues, in accordance with the procedure as tested within CaSa-project. This compost can be used in the <i>msiri</i>².</p>
<p>Made of mud/grasses, roofed with iron sheets: ≈ 250,000 TZS ≈ 100 € (labour costs) Made of bricks with roofing tiles: ≈ 900,000 TZS ≈ 360 € (material & labour costs)</p>	<p>≈ 450,000 TZS ≈ 180 € (material costs) ≈ 500,000 TZS ≈ 200 € (labour costs)</p>	<p>≈ 630,000 TZS ≈ 250 € (material costs) ≈ 500,000 TZS ≈ 200 € (labour costs)</p>

Non-common abbreviations: CaSa-project “Carbonization and Sanitation”; EcoSan: ecological sanitation; UDDT: urine-diverting dry toilet; TZS: Tanzanian shilling.

Notes: Costs were transferred from TZS to € by applying an exchange rate of 1,000 TZS = ≈0.40 €. // Sources for the costs: Expert judgement (Mavuno, 2015) for S1 and S4; CaSa project-accounting, pilot phase 2012 for S2 and S3.

Sources: Pit latrine: photo: A. Krause; drawing: Brikké and Bredero, 2003;

UDDT: photo: A. Krause; drawing: <http://www.ingenieure-ohne-grenzen.org/de/content/download/23394/134705/file/How%20to%20build%20a%20UDDT%20-%20Construction%20Manual%20-%20English.pdf>;

CaSa: photo: A. Krause; drawing: <http://www.ingenieure-ohne-grenzen.org/de/content/download/23393/134699/file/How%20to%20build%20an%20oven%20-%20Construction%20Manual%20-%20english.pdf>

¹ *Shamba* is the local name for perennial, mostly banana-based cropping systems.

² *Msiri* is the local name for the intercropping of temporary crops including maize, beans, and vegetables.

Modelling the SNB: system definition

Table S.4: Definition of the system analysed

Defining element	Description of the farming system
Problem description	Continuously declining soil fertility due to the lack of available organic fertilizers. Locally available residues from cooking and sanitation are not yet integrated in the soil fertility management.
Developed countermeasures	Local initiatives recently started testing IPNM-strategies including the use of (i) biogas slurry as organo-mineral fertilizer; (ii) stored urine as mineral fertilizer; (iii) 'CaSa-compost' containing sanitized human excreta mixed with biochar and other domestic residues, prepared according to the principles of Terra Preta; (iv) standard compost containing ashes, harvest residues, and kitchen residues.
Specific objective	Comparison of the soil management in Karagwe at the current state with specific IPNM-strategies regarding effects on (i) soil nutrient balances, (ii) subsistence production of compost, and (iii) environmental emissions.
Activities	To subsist, which for the AES specifically comprises (i) to make compost and (ii) to grow locally relevant food crops, which includes cultivating staple crops, legumes, and vegetables.
Spatial system boundary	One smallholder farm in Karagwe including the land used for the intercropping of annual crops (land called msiri) at 0.125 ha. The msiri was used for growing maize, beans, onion, and cabbage on 80 %, 15 %, 2.5 %, and 2.5 % of the land, respectively.
Temporal boundary	One year with two seasons, or two cultivation periods.
Indicator substances	C as structural element of SOM; N and P as essential plant nutrients in farming.

Abbreviations: IPNM: integrated plant nutrient management; SOM: soil organic matter

Modelling the SNB: results used in discussion

Table S.5: Estimated application rates of the organic and mineral inputs studied in scenarios AM1-AM5 in kg of FM per household and year

Alternative	Application rate				
	Standard compost kg m ⁻² yr ⁻¹	CaSa-compost kg m ⁻² yr ⁻¹	Biogas slurry dm ³ m ⁻² season ⁻¹	Urine: maize dm ³ m ⁻² season ⁻¹	Urine: vegetables dm ³ m ⁻² season ⁻¹
AM1	4.4 ±1.4	NA	NA	NA	3.6 ±1.8
AM2	2.8 ±1.0	NA	3.2 ±1.0	0.3 ±0.3	1.7 ±1.0
AM3	2.6 ±0.5	1.8 ±0.2	NA	0.2 ±0.03	1.6 ±0.7
AM4	2.0 ±0.5	1.7 ±0.1	NA	0.1 ±0.04	2.0 ±0.7
AM5	11.3 ±1.8	5.5 ±0.5	NA	0.5 ±0.3	0.5 ±0.1

Abbreviations: CaSa-compost: compost produced in project 'Carbonizations and sanitation'; FM: fresh matter; NA: not analysed (i.e. not considered in scenario)

Table S.6: Estimated P-inputs with organic and mineral inputs studied in scenarios AM1-AM5 in kg of P per hectare and year

Alternative	P-inputs		
	Standard compost kg P ha ⁻¹ yr ⁻¹	CaSa-compost kg P ha ⁻¹ yr ⁻¹	Biogas slurry kg P ha ⁻¹ yr ⁻¹
AM1	62 ±21	NA	NA
AM2	32 ±12	NA	21 ±9
AM3	29 ±10	38 ±6	NA
AM4	25 ±11	35 ±6	NA
AM5	154 ±51	113 ±17	NA

Abbreviations: CaSa-compost: compost produced in project 'Carbonizations and sanitation'; NA: not analysed (i.e. not considered in scenario); P: Phosphorus

Table S.7: Estimated liming effects of the organic material expressed in equivalent application in kg of CaO per hectare and year calculated with liming potentials presented in Krause et al. (2015)

Alternative	Liming effect		
	Standard compost kg CaO ha ⁻¹ yr ⁻¹	CaSa-compost kg CaO ha ⁻¹ yr ⁻¹	Biogas slurry kg CaO ha ⁻¹ yr ⁻¹
AM1	428 ±146	NA	NA
AM2	299 ±100	NA	229 ±115
AM3	276 ±78	652 ±109	NA
AM4	225 ±76	637 ±126	NA
AM5	1,362 ±303	1,957 ±333	NA

Abbreviations: CaO: lime; CaSa-compost: compost produced in project 'Carbonizations and sanitation'; NA: not analysed (i.e. not considered in scenario)

Table S.8: Estimated C-inputs with organic and mineral inputs studied in scenarios AM1-AM5 in kg of C per hectare and year

Alternative	C-inputs				
	Standard compost		CaSa-compost	Biogas slurry	
	kg C ha ⁻¹ yr ⁻¹		kg C ha ⁻¹ yr ⁻¹	kg C ha ⁻¹ yr ⁻¹	
AM1	3,897	±1,316	NA	NA	
AM2	3,412	±1,426	NA	1,025	±438
AM3	2,960	±1,276	2,607	±617	NA
AM4	2,835	±1,362	2,374	±634	NA
AM5	18,076	±5,414	7,822	±1,851	NA

Abbreviations: C: Carbon; CaSa-compost: compost produced in project 'Carbonizations and sanitation'; NA: not analysed (i.e. not considered in scenario)

Table S.9: Estimated SOM reproduction potentials with organic and mineral inputs studied in scenarios AM1-AM5 in kg of C in SOM per hectare and year

Alternative	SOM-C-inputs				
	Standard compost		CaSa-compost	Biogas slurry	
	kg SOM-C ha ⁻¹ yr ⁻¹		kg SOM-C ha ⁻¹ yr ⁻¹	kg SOM-C ha ⁻¹ yr ⁻¹	
AM1	1949	±658	NA	NA	
AM2	1706	±713	NA	256	±110
AM3	1480	±638	1304	±308	NA
AM4	1417	±681	1187	±317	NA
AM5	9038	±2707	3911	±925	NA

Abbreviations: C: Carbon; CaSa-compost: compost produced in project 'Carbonizations and sanitation'; NA: not analysed (i.e. not considered in scenario); SOM: soil organic matter

Table S.10: Available materials for organic and mineral fertilization in kg yr⁻¹ of FM

Alternative	Available organic and mineral input materials										
	Total residues		Residues used for mulching		Standard compost		CaSa-compost		Biogas slurry		Urine
	kg yr ⁻¹		kg yr ⁻¹		kg yr ⁻¹		kg yr ⁻¹		kg yr ⁻¹		kg yr ⁻¹
AM1	993	±118	468	±60	346	±48	NA	NA		NA	
AM2	1567	±188	740	±96	476	±69	NA	14955	±3118	1364	±184
AM3	2793	±273	1318	±158	235	±37	2183	±210	NA	583 ±193	
AM4	1898	±214	896	±113	168	±26	2026	±194	NA	583 ±193	
AM5	2793	±273	1318	±158	235	±37	2183	±210	NA	583 ±193	

Abbreviations: FM: fresh matter; NA: not analysed, i.e. the respective matter was not considered in this scenario. Scenarios are defined in Table 3. Mulching material was 47 ± 6.5 % of total agricultural residues and completely utilized.

Table S.11: Utilization of the matter as input material in % of available FM.

Alternative	Utilization							
	Standard compost		CaSa-compost	Biogas slurry		Urine		
	%		%	%		%		
AM1	40	±14	NA	NA		NA		
AM2	37	±26	NA	51	±19	65	±58	
AM3	69	±17	100	±0	NA	100	±35	
AM4	75	±21	100	±8	NA	99	±18	
AM5	100	±0	100	±0	NA	100	±6	

Abbreviations: FM: fresh matter; NA: not analysed, i.e. the respective matter was not considered in this scenario. Scenarios are defined in Table 3. Mulching material was 47 ± 6.5 % of total agricultural residues and completely utilized.

Modelling the SNB: plot data to results presented in figures

Table S.12: Estimated SNB for N and P comprising natural input (IN3a, 4a, 4b) and natural output (OUT3, 4a) flows; organic (IN2a-2e) and mineral (IN1c) input flows; and output flows (Out1a, 1b, 2) with agricultural products; in kg of N and P per household and year; plot data for Fig. 3.

Flow Name	Abbrev.	kg N ha ⁻¹ yr ⁻¹					kg P ha ⁻¹ yr ⁻¹				
		AM1	AM2	AM3	AM4	AM5	AM1	AM2	AM3	AM4	AM5
Own consumption	OUT1a	-23.8	-44.0	-67.0	-51.2	-67.0	-4.8	-9.2	-15.6	-11.0	-15.6
Sold to market	OUT1b	-8.4	-18.1	-30.3	-21.9	-30.3	-2.2	-4.5	-9.4	-5.7	-9.4
Harvest residues total	OUT2	-34.3	-55.4	-94.7	-66.7	-94.7	-8.9	-14.8	-26.7	-18.1	-26.7
Grass carpet	IN2a	5.3	5.3	5.3	5.3	5.3	0.9	0.9	0.9	0.9	0.9
Mulching with crop residues	IN2b	15.4	24.6	47.4	30.4	47.4	4.2	7.0	12.6	8.5	12.6
Compost (for cabbage)	IN2c	4.1	5.8	5.3	4.4	8.8	1.5	1.6	1.4	1.3	2.6
CaSa-compost	IN2d	NA	NA	79.7	72.9	79.7	NA	NA	35.8	33.2	35.8
Biogas slurry	IN2e	NA	51.8	NA	NA	NA	NA	20.1	NA	NA	NA
Urine	IN1c	NA	30.1	19.8	19.6	19.8	NA	3.3	2.2	2.2	2.2
Leaching	OUT3	-12.3	-12.3	-12.3	-12.3	-12.3	NA	NA	NA	NA	NA
Gaseous losses, denitrification	OUT4a	-13.8	-13.8	-13.8	-13.8	-13.8	NA	NA	NA	NA	NA
Atmospheric deposition - wet	IN3a	6.4	6.4	6.4	6.4	6.4	0.9	0.9	0.9	0.9	0.9
BNF_symbiotic	IN4a	3.6	5.2	25.5	8.6	25.5	NA	NA	NA	NA	NA
BNF_asymbiotic	IN4b	3.3	3.3	3.3	3.3	3.3	NA	NA	NA	NA	NA
Full SNB	SNB	-54	-11	-25	-15	-22	-8	6	2	12	3
NB	NB	-13	-11	9	-8	9	0.9	0.9	0.9	0.9	0.9

Abbreviations: BNF: symbiotic biological nitrogen fixation; CaSa-compost: compost produced in project 'Carbonizations and sanitation'; NA: not analysed (i.e. not considered in scenario); NB: natural balance; SNB: soil nutrient balance. Alternatives AM1-AM5 are defined in Table 3.

Table S.13: Estimated environmental impacts of the analysed IPNM-strategies: the global warming potential in kg of CO₂ equivalents per household and year; plot data for Fig. 5a

Flow Name	Abbrev.	kg CO ₂ -e hh ⁻¹ yr ⁻¹				
		AM1	AM2	AM3	AM4	AM5
Carpeting and mulching	N ₂ O	40.4	58.5	103.0	69.8	103.0
Burning residues	CO ₂	19.2	30.4	54.1	36.8	54.1
Burning residues	CO	2.3	3.7	6.6	4.5	6.6
Burning residues	CH ₄	1.0	1.5	2.7	1.8	2.7
Burning residues	N ₂ O	0.2	0.4	0.7	0.5	0.7
Burning residues	Nox	-0.3	-0.6	-1.0	-0.7	-1.0
Composting	CO ₂	281	409	205	145	205
Composting	N ₂ O	36.4	49.0	28.1	19.0	28.1
CaSa-composting	CO ₂	NA	NA	1127.4	987.4	1127.4
CaSa-composting	N ₂ O	NA	NA	227.1	205.9	227.1
Biogas slurry	N ₂ O	NA	921.15	NA	NA	NA
Urine	N ₂ O	NA	32.5	21.4	21.2	21.9
Total	Sum	380	1506	1775	1491	1776

Abbreviations: hh: household; IPNM: integrated plant nutrient management; NA: not analysed (i.e. not considered in scenario)

Table S.14: Estimated environmental impacts of the analysed IPNM-strategies: the eutrophication potential in kg of PO₄ equivalents per household and year; plot data for Fig. 5b

Flow Name	Abbrev.	kg PO ₄ -e hh ⁻¹ yr ⁻¹				
		AM1	AM2	AM3	AM4	AM5
Carpeting and mulching	NH ₃	0.15	0.21	0.37	0.25	0.37
Burning residues	NO _x	0.00	0.01	0.01	0.01	0.01
Composting	NH ₃	0.35	0.51	0.27	0.18	0.27
Composting	P-leaching	0.25	0.14	0.07	0.05	0.07
CaSa-composting	NH ₃	0.00	0.00	2.21	2.00	2.21
CaSa-composting	P-leaching	0.00	0.00	0.69	0.64	0.69
Biogas slurry	NH ₃	0.00	0.03	0.00	0.00	0.00
Biogas slurry	N-leaching	0.00	0.14	0.00	0.00	0.00
Urine	NH ₃	0.00	0.13	0.09	0.09	0.09
Urine	N-leaching	0.00	0.07	0.05	0.05	0.05
Total	Sum	0.75	1.25	3.76	3.27	3.76
Total (without P-leaching)	Sum	0.50	1.11	3.00	2.58	3.00

Abbreviations: hh: household; IPNM: integrated plant nutrient management; NA: not analysed (i.e. not considered in scenario)

Table S.15 Integrated environmental impacts with GWP of the MES, the MSS, and the AES in kg of CO₂ equivalents per household and year; plot data for Fig. S.4a

	AM1	AM2	AM3	AM4	AM5
	kg CO ₂ -e hh ⁻¹ yr ⁻¹				
GWP_MES	2742	6870	1401	1401	1401
GWP_MSS	218	77	282	282	282
GWP_AES	380	1506	1775	1491	1776
Sum	3340	8452	3459	3175	3459

Abbreviations: AES: agroecosystem; GWP: global warming potential; hh: household; MES: micro energy systems; MSS: micro sanitation system

Table S.16 Integrated environmental impacts with EP of the MES, the MSS, and the AES in kg of PO₄ equivalents per household and year; plot data for Fig. S.4b

	AM1	AM2	AM3	AM4	AM5
	kg PO ₄ -e hh ⁻¹ yr ⁻¹				
EP_MES	0.9	2.9	0.4	0.4	0.4
EP_MSS	7.4	0.2	0.2	0.2	0.2
EP_AES	0.8	1.2	3.8	3.3	3.8
Sum	9.0	4.3	4.4	3.9	4.4

Abbreviations: AES: agroecosystem; EP: eutrophication potential; hh: household; MES: micro energy systems; MSS: micro sanitation system

Table S.17: Evaluation SNB – regression analysis: estimated biological N fixation and estimated natural balance in kg of N per household and year; plot data for Fig. S.3

Scenario	BNF		NB	
	kg N hh ⁻¹ yr ⁻¹		kg N hh ⁻¹ yr ⁻¹	
AM1	12	±3	-13	±5
AM2	17	±4	-11	±5
AM3/5	85	±17	9	±6
AM4	29	±7	-8	±5

Abbreviations: BNF: symbiotic biological nitrogen fixation; hh: household; NB: natural balance; SNB: soil nutrient balance

Modelling composting processes: plot data to results presented in figures

Table S.18: Relative contribution of the different resources used for standard composting and for CaSa-composting to the total input flow in terms of volume and content of C, N, and P prior to the composting process in %; plot data for Fig. 4a

Alternative	AM1				AM2-5 (average)			
	Vol.	C	N	P	Vol.	C	N	P
Input flow	vol-%		wt-%		vol-%		wt-%	
Harvest residues	0.85	0.79	0.75	0.28	0.93	0.88	0.86	0.84
Kitchen waste	0.12	0.21	0.25	0.09	0.06	0.12	0.14	0.12
Ashes (from agriculture)	0.00	NA	NA	0.01	0.00	NA	NA	0.04
Ashes (from cooking)	0.03	NA	NA	0.62	NA	NA	NA	NA

Abbreviations: C: carbon; N: nitrogen; NA: not analysed (i.e. not considered in scenario); P: phosphorus; Vol: volume; wt: weight

Table S.19: Relative contribution of the different resources used for standard composting and for CaSa-composting to the total input flow in terms of volume and content of C, N, and P prior to the composting process in %; plot data for Fig. 4b

Alternative	AM3-5 (average)			
	Vol.	C	N	P
Input flow	vol-%		wt-%	
Sanitized solids (from UDDT)	0.15	0.09	0.25	0.25
Biochar (from sanitation)	0.01	0.02	0.00	0.02
Biochar (from cooking)	0.17	0.38	0.06	0.14
Harvest residues	0.40	0.34	0.22	0.18
Kitchen waste	0.02	0.04	0.03	0.02
Ashes (from agriculture)	0.06	0.0	0.0	0.01
Sawdust	0.01	0.07	0.02	0.01
Soil	0.19	0.05	0.15	0.26

Abbreviations: C: carbon; N: nitrogen; P: phosphorus; UDDT: urine diverting dry toilet; Vol: volume; wt: weight

Modelling the SNB: additional results of food production

Table S.20: Material output flows of *food products* (i.e. maize and beans grains, cabbage heads, and onion bulbs) in kg of FM (after air-drying for maize, beans, and onion) per household and year

Alternative	Maize		Beans		Cabbage		Onion	
	kg	hh ⁻¹ yr ⁻¹	kg	hh ⁻¹ yr ⁻¹	kg	hh ⁻¹ yr ⁻¹	kg	hh ⁻¹ yr ⁻¹
AM1	243	±6	25	±4	258	±58	24	±6
AM2	525	±66	35	±11	258	±58	88	±10
AM3/5	877	±103	184	±21	258	±58	88	±10
AM4	636	±75	60	±15	258	±58	88	±10

Abbreviations: hh: household; FM: fresh matter

Table S.21: Material output flows of *food products for self-consumption* in kg of FM (after air-drying for maize, beans, and onion) per household and year

Alternative	Maize		Beans		Cabbage		Onion	
	kg	hh ⁻¹ yr ⁻¹	kg	hh ⁻¹ yr ⁻¹	kg	hh ⁻¹ yr ⁻¹	kg	hh ⁻¹ yr ⁻¹
AM1	159	±32	9	±2	258	±77	24	±8
AM2	344	±81	13	±5	258	±77	88	±20
AM3/5	574	±133	70	±16	258	±77	88	±20
AM4	417	±97	23	±7	258	±77	88	±20

Abbreviations: hh: household; FM: fresh matter

Table S.22: Material output flows of *food products sold to market* in kg of FM (after air-drying for maize, beans, and onion) per household and year

Alternative	Maize		Beans		Cabbage		Onion	
	kg	hh ⁻¹ yr ⁻¹	kg	hh ⁻¹ yr ⁻¹	kg	hh ⁻¹ yr ⁻¹	kg	hh ⁻¹ yr ⁻¹
AM1	84	±17	15	±4	0	±0	0	±0
AM2	181	±43	22	±8	0	±0	0	±0
AM3/5	303	±70	114	±26	0	±0	0	±0
AM4	219	±51	37	±12	0	±0	0	±0

Abbreviations: hh: household; FM: fresh matter

Table S.23 Material output flows of *harvest residues* in kg of FM (at time of harvesting) per household and year

Alternative	From maize		From beans		From cabbage		From onion		Total
	kg	hh ⁻¹ yr ⁻¹	kg	hh ⁻¹ yr ⁻¹	kg	hh ⁻¹ yr ⁻¹	kg	hh ⁻¹ yr ⁻¹	kg
AM1	763	±82	37	±8	189	±84	4	±1	993
AM2	1,318	±167	53	±8	189	±84	7	±2	1,567
AM3/5	2,353	±259	245	±18	189	±84	7	±2	2,793
AM4	1,616	±196	87	±13	189	±84	7	±2	1,898

Abbreviations: hh: household; FM: fresh matter

Table S.24: Relative uncertainties (RU) of results calculated defined as the standard error in % of the arithmetic mean value

Alternative	Nutrient requirement of crops		Nutrient supply with organic and mineral fertilization		Natural balance		Full SNB with organic and mineral fertilization	
	N	P	N	P	N	P	N	P
AM1	4%	9%	2%	1%	15%	35%	5%	12%
AM2	4%	8%	16%	15%	17%	35%	125%	63%
AM3	4%	8%	8%	12%	25%	35%	38%	224%
AM4	8%	17%	18%	18%	69%	35%	112%	43%
AM5	4%	8%	11%	16%	25%	35%	50%	163%

Abbreviations: N: nitrogen; P: phosphorus; RU: relative uncertainty

According to Laner et al. (2013), RU-values of < 30 %, ± 50 %, or > 90 % indicate **low**, **average**, or **high** uncertainty, respectively.

Preliminary remark to the appendix for the modelling approach

Supplementary 1 first briefly introduces basic definitions of the agroecosystem (AES). We outline the farming system analysed for the case of smallholder farming in Karagwe, in Northwest Tanzania (TZ) (S1.1), describe the scenarios studied including farming practices considered (S1.2), explain the method applied for modelling as well as the general structure of the model (S1.3). We also disclose the basic assumptions that we took, including those for simplifying the model to make it applicable in the present context (S1.4). The first chapter ends with an annotated list of selected flows of the model presented in Table S27. In Chapter S2, we explain the sets of equations used to systematically quantify relevant material flows while modelling the AES (S2) including composting processes (S2.6). In S3, we briefly explain how we assessed the environmental emissions. In S4 we shortly discuss selected assumptions and simplification in addition to the major discussion as part of the main article. In S5, we provide information about our data collection and a list of all parameter values used (Table S32). In S6, we list specific words which we use in this document.

Supplementary 1.

1.1. Basic description of the agroecosystem analysed.

The basic definition of the AES-model includes (i) the ‘housing system’, representing the farming household, (ii) the ‘farming system’, describing the size of planted farmland, and (iii) the ‘land use’ (LU), describing the distribution of land for selected crops (Table S25). The farming household further comprises the micro energy system (MES) and the micro sanitation system (MSS), and has been systematically analysed in Krause and Rotter (2017). The total planted farmland consists of fields called *msiri*, used for growing annual crops, and fields called *shamba*, used for growing perennial crops. Only the *msiri* are included in the present analysis. The housing system and farming system are connected through a composting process, which is assigned to the farming system. *Locally available materials* for composting and fertilization include resources recovered from cooking in the MES and sanitation, i.e. from the MSS (*ibid.*).

Table S25: Basic description of the AES.

Housing system	Farming system	Land use of the <i>msiri</i>
Number of people per family: 6	Total size of planted farmland: 0.625 ha	Maize 80%
Number of families: 1	Size of planted farmland used as <i>shamba</i> : 0.5 ha	Beans 15%
Years of modelling: 1	Size of planted farmland used as <i>msiri</i> : 0.125 ha	Onion 2.5%
Cultivation periods per year: 2		Cabbage 2.5%

The **temporary system boundary** of the model is one year. The **spatial system boundary** includes the *msiri* and refers to a typical smallholder farm in Karagwe (cf. Table 1 in main article). The modelling is done in the layers of goods (G), and indicator substances include carbon (C), nitrogen (N), and phosphorus (P). One farming year includes two cropping seasons. The model factor (MF; in ha yr⁻¹) reflects the total cultivation area per year (Eq.S1) and is the product of the two cultivation periods per year (*periods_{cult.}*) and the size of the planted farmland used as *msiri* (*area_{msiri}*). The MF is used in most equations, in combination with the LU, to estimate crop specific **annual material flows** (\dot{m} in kg yr⁻¹), such as in- and output flows of nutrients to and from the farmland, respectively (see Supplementary S2).

$$MF = \textit{periods}_{cult.} \cdot \textit{area}_{msiri} = 2 \cdot 0.125 \quad \text{Eq. (S1)}$$

In sum, **five scenarios** are compared for the agricultural system *msiri* (AM1-5). Each scenario represents a strategy of *integrated plant nutrient management* (IPNM). Hence, scenarios are principally defined by the fertilization strategy applied specifying different fertilizer inputs used, including residues recovered from the farming household. Overall, the current state farming practices (AM1), where mineral and organic material inputs (\dot{m}_{input}) are exclusively used for cultivating cabbage, are compared to the use of biogas slurry as an organic \dot{m}_{input} in combination with urine as a

mineral \dot{m}_{input} (AM2), and to the use of CaSa-compost as an organic \dot{m}_{input} in combination with urine as a mineral \dot{m}_{input} (AM3-5) (cf. Supplementary 1.3).

Before going more into detail about the scenarios analysed, we briefly elaborate system definition, which we based on local conditions. To describe agricultural activities as common in the region, we refer to the **national census** of agriculture in the Kagera region (Tanzania, 2012) and available monitoring data of the partner organisation MAVUNO Project (Mavuno, 2015):

- On average, the total area available to one smallholder farm in Karagwe is approx. 0.75 ha **usable land** (equivalent to approx. 2 acres).
- Approximately 83 % of this land is used for agriculture, which results in approx. 0.625 ha of **planted land** per household.
- From the total planted land, 0.5 ha are allocated to *shamba* and **0.125 ha to msiri**.
- We only consider **locally available residues as organic inputs** to farmland, such as biogas slurry, compost, and CaSa-compost as well as urine as a **mineral input**.
- Use of **animal manure is not considered** because the present analysis focussed on (i) structurally poor households that generally do not possess animals and (ii) vegan organic farming.
- **Synthetic fertiliser are not used** because (i) most smallholders practice organic agriculture and (ii) there is a general lack of financial or logistical access to commercial fertilizers. According to national statistics, commercial synthetic fertilizers are used on less than 1 % of the planted land in Karagwe whilst about 78 % of the farmers who apply fertilizers use organic fertilizer.
- For the cultivation of food crops we focus on locally cultivated and nutrition-relevant food crops and selected **maize** as a staple food, **beans** as a legume food, and **cabbage** and **onion** as vegetables.
- We assumed that maize, beans, and vegetables are cultivated on, respectively, 1,000, 187.5, 62.5 m² of *msiri* farmland. The area for vegetables is further distributed to onion and cabbage by 50 % each.
- Beans are important in the local AES by contributing to the input of N through symbiotic **biological nitrogen fixation** (BNF).
- **Plant growth** is assumed based on the field experiment, which we conducted in Karagwe in 2014 (Krause et al., 2016). From this experiment, we have specific results for total biomass production and crop yields available for each of the four crops corresponding to the use of biogas slurry, standard compost, CaSa-compost, or no fertilizing input (i.e. 'current state').
- In order to reduce the evapotranspiration of soil, water, and wind-erosion during dry seasons, the ground is commonly covered with grass cuttings ('**grass carpeting**') and a certain share of agricultural residues for '**mulching**', respectively.

1.2. Definition of scenarios defined.

The following paragraph presents the IPNM-strategies analysed, respectively scenarios AM1-AM5, in more detail.

In the scenario reflecting the **current state** of soil fertility management (**AM1**), only standard compost is used as an organic input, and *only* for cabbage due to the following reasons: (I) In general, most farmers in Karagwe and Kagera do not use fertilizers (see above). (II) It is barely possible to cultivate cabbage in the region without the addition of fertilizer (Krause et al., 2016; Mavuno, 2015). Therefore, applying compost to the area planted with cabbage is defined as a 'minimum requirement' in current cultivation practices.

The **Karagwe standard compost** (Fig. 1) is prepared from locally available residues including grasses, harvest residues, and ashes which are residues from cooking with a three-stone fire (Krause et al., 2015). The composting process is modelled as part of the present AES-model (Supplementary 2.6.I). The amount of ashes available from cooking that can be used for composting is quantified in Krause and Rotter (2017) in alternative E1 in the MES-model. The assumed biomass growth and crop yields used for modelling AM1 are based on a mean value for unamended soils in Krause et al. (2016) combined with literature values, specific to the region.



Figure S6: Locally produced Karagwe standard compost (own picture, March 2014).

In **scenario AM2**, biogas slurry is used as an organic fertilizer, which is available as residue from using small-scale biogas digesters. The slurry is used for fertilizing only the area cultivated with maize and beans. The area cultivated with vegetables, both cabbage and onion, is amended with standard compost. In addition, urine is used as mineral fertilizer for all crops. The available amount of biogas slurry from cooking that can be used for fertilization is quantified in Krause and Rotter (2017) in alternative E6 in the MES-model. Assumptions of biomass growth and crop yield are based on own empiric results from using biogas slurry for maize and beans alongside compost for cabbage and onion (Krause et al., 2016).



Figure S7: Biogas slurry taken from the outlet of a biogas digester constructed as pilot digester in Karagwe (own picture, March 2014).

In **scenario AM3**, the area cultivated with maize and beans is amended with so-called ‘CaSa-compost’. Preparing CaSa-compost is tested in the project ‘Carbonization and Sanitation’ (CaSa), which acts as a case study to the present work (cf. main article). The area cultivated with vegetables, both cabbage and onion, is amended with standard compost. In addition, urine is used as mineral fertilizer for all crops. Standard and CaSa-composting processes are modelled as part of the present AES-model (Supplementary 2.6.I and 2.6.II, respectively). According to Krause et al. (2015), CaSa-compost contains a mix of pasteurised human faeces, kitchen waste, harvest residues, terracotta particles, ash, and urine mixed with biochar. Biochar, which is available from cooking and from thermal sanitation is quantified in Krause and Rotter (2017) in alternative E4 as part of the MES-model and in alternative S3 in the MSS-model, respectively. Weights and volumes of urine and sanitized human faeces recovered from sanitation are also quantified in Krause and Rotter (2017) in alternative S3 in the MSS-model. Assumptions of biomass growth and crop yield are based on own empiric results from using CaSa-compost for maize and beans and standard compost for cabbage and onion (Krause et al., 2016).

The IPNM-strategy analysed in **scenario AM4** is generally comparable to that studied in AM3. The main difference is that, in AM4, yields estimated for total biomass and grains are lower compared to AM3. In AM4, the assumed biomass growth and crop yield are based on results from using standard compost described in Krause et al. (2016) *for all crops*. We did this, because results gained by using CaSa-compost in the local experiment have been remarkably high. However, the experiment lasted only for one season and an empiric *proof* of results is pending. It is therefore somehow speculative, to assume that such high results can be realized for both of the two cultivation periods per year and in the long run or for many consecutive seasons. Thus, with AM4 we introduced another *more conservative* scenario in comparison to AM3 but with the same assumptions in terms of fertilizer applications to land used as *msiri*.



Figure S8: CaSa-compost produced in pilot project of CaSa-project in Karagwe, TZ (own picture, March 2014).

Also, **scenario AM5** is comparable to AM3. However, in AM5, nutrients are supplied with a one-off large amendment of organic fertilizers and additional seasonal mineral inputs through urine application. This means that total composts prepared during one year are amended on one third of the cultivated land. In the process, standard compost and CaSa-compost are used for growing vegetables and maize/beans, respectively. This application is repeated every year and on a rotating basis. Through this practice, the whole area is amended with compost after three years. In contrast, the compost is applied to the same area every four years again. The assumed biomass growth and crop yield in AM5 are comparable to AM3.



Figure S9: Urine is collected and stored in a urine-diverting dry toilet (UDDT); storage lasts for minimum two months in order to successfully inactivate pathogens (drawing from CaSa-project document, CC).

1.3. Method applied and basic organisation of computational work.

In the AES-model, we applied the **method of soil nutrient balances** (SNB). Essentially, we combined concepts and terminologies as introduced by Stoorvogel and Smaling (1990) and modifications of Stoorvogel et al. (1993), Smaling et al. (1996) and Lesschen et al. (2007). We further followed Van den Bosch et al. (1998) and divided the *full SNB* into a *natural balance* (NB) and a *partial balance* (PB). The NB comprises all immissions and emissions from and to the environment and the PB reflects the ‘way of farming’ and solely consists of organic and mineral fertilizer inputs and nutrient removals by food crops and harvest residues. After an exhaustive literature review, we selected those flows which were most relevant and quantifiable in the specific context (Table S27). Our specific modelling approach is summarized in the following paragraph and is also further described and visualised in the main article (Section 2.3. and Fig. 2).

The chosen **fertilization strategy** is based on (i) optimizing P-efficiency, (ii) avoiding over-fertilization with P, and (iii) avoiding under-fertilization with N. Hence, our model follows suggestions put forth by Buresh et al. (1997) and Eghball and Power (1999), stating that if the ratio of N/P of the crops’ nutrient requirement is higher than the ratio of N/P in organic fertilizer, then organic matter should be used first to balance the P uptake of crops. Mineral fertilizer can also be used to meet crops’ N requirements. In most of the scenarios in our model, the N/P of the crops’ nutrient requirement is higher than N/P in organic fertilizers, thus $\frac{N}{P_{\text{mineral input}}} \geq \frac{N}{P_{\text{crops requirement}}} \geq \frac{N}{P_{\text{organic inputs}}}$ (Table S26).

Table S26: N/P-ratios in nutrient requirements of crops and in the soil amendments for the analysed scenarios (AM1-AM5).

	Crops’ nutrient requirements	Organic input					Mineral input	
		Compost (lab)	Compost (mod)	Biogas slurry (lab)	Biogas slurry (mod)	CaSa (lab)	CaSa (mod)	Urine
AM1	4.2	4.2	1.1	NA	NA	NA	NA	NA
AM2	4.4	4.2	2.9	2.1	3.1	NA	NA	9.0
AM3	3.7	4.2	3.1	NA	NA	1.9	2.6	9.0
AM4	4.2	4.2	2.9	NA	NA	1.9	2.5	9.0
AM5	3.7	4.2	3.1	NA	NA	1.9	2.6	9.0

To sum up: organic inputs such as standard compost, CaSa-compost, and biogas slurry are used to meet crop’s primary requirements for P, to complement organic amendments, and to supply additional N. Stored urine is used as a liquid mineral fertiliser. Urine is known as a fast acting and rapidly available N-fertiliser, which is often diluted with water, e.g. in a ratio of 1:3 to 1:5 urine to water (Richert et al., 2010). Dilution is mainly done to avoid over-utilisation of urine and to reduce the odour. If urine is rather used neat, Richert et al. (2010) recommended applying the urine into a furrow or hole and to close the furrow/hole with soil afterwards. This can reduce N-losses through sub-surface volatilization. In order to restore soil P stocks efficiently, Buresh et al. (1997) further recommend either seasonal moderate applications of organic fertilizers or one-off large applications. The first recommendation is considered in scenarios AM1-4, the latter in scenario AM5, as described above.

Calculations were made through a **series of steps**. Here we briefly summarize the principle procedure and further elaborate the steps including the equations applied in Supplementary 2. The first step was to estimate the NB (Supplementary 2.1 and 2.2). Values of IN and OUT for the NB derive from literature (Table S27). Then, we calculated the total biomass production for PB, including crop yields and plant residues, and the respective total nutrient uptake by plants (OUT_{crops} ; Supplementary 2.3). Grass carpeting and mulching with residues are considered local standard practices, and are therefore included as organic IN into ‘PB I without fertilization’ (Eq. S2). It follows, therefore, that PB I reflects the ‘net nutrient requirements’ of crops. Application of organic and mineral fertilizers are considered in ‘PB II with organic fertilization’ (Eq. S3), and ‘PB III with organic *and* mineral fertilization’ (Eq. S4), respectively. Organic and mineral INs are quantified based on the net nutrient requirements calculated in PB I (Supplementary 2.4). Finally, ‘full SNB I with organic fertilization’ (Eq. S5) and ‘full SNB II with organic and mineral fertilization’ (Eq. S6) are calculated.

$$\text{PB I} \stackrel{\text{def}}{=} \text{IN}_{\text{carpeting}} + \text{IN}_{\text{mulching}} - \text{OUT}_{\text{crops}} = \text{IN}_{2a} + \text{IN}_{2b} - \sum (\text{OUT}_{1a} + \text{OUT}_{1b} + \text{OUT}_2) \stackrel{\text{def}}{=} |\text{nutrient requirement}_{\text{crops}}| \quad \text{Eq. (S2)}$$

$$\text{PB II} \stackrel{\text{def}}{=} \text{PB I} + \text{IN}_{\text{compost}} + \text{IN}_{\text{CaSa-compost}} + \text{IN}_{\text{biogas slurry}} = \text{PB I} + \text{IN}_{2c} + \text{IN}_{2d} + \text{IN}_{2e} \quad \text{Eq. (S3)}$$

$$\text{PB III} \stackrel{\text{def}}{=} \text{PB II} + \text{IN}_{\text{urine}} = \text{PB II} + \text{IN}_{1c} \quad \text{Eq. (S4)}$$

$$\text{SNB I} \stackrel{\text{def}}{=} \text{NB} + \text{PB II} \quad \text{Eq. (S5)}$$

$$\text{SNB II} \stackrel{\text{def}}{=} \text{NB} + \text{PB III} \quad \text{Eq. (S6)}$$

where IN is the nutrient input flows, OUT is the nutrient output flows, PB is the partial balance, NB is the natural balance, and SNB is the full soil nutrient balance.

In addition to the SNB, the AES-model also includes a preceding process, which is the **composting**. Here, different organic waste materials are mixed for the subsequent aerobic, bio-chemical decomposition. Two approaches to composting are depicted in the model: (i) the ‘standard composting’, which follows local practices and primarily includes harvest and kitchen residues (Supplementary 2.6.I), and (ii) the ‘CaSa-composting’, which is applied to jointly exploiting biochar, stored urine, sanitized faeces, and other organic residues (Supplementary 2.6.II). During composting, emissions to the natural environment occur, such as CO₂-, CH₃-, or N₂O-emissions, or P-leaching.

In aggregating the data, we assumed that all parameters were normally distributed and independent of variables (Laner et al., 2014). All mathematical operations are first carried out with an arithmetic mean value of (\bar{x}). To apply **error propagation statistics**, we calculate standard error (Δx), which derives from the standard deviation (σ) of the test series or data set, and the relative uncertainty (RU), which is defined as Δx in % of \bar{x} (Brunner and Rechberger, 2004). Finally, *Gauss’s law of error propagation* (Brunner and Rechberger, 2004; FAU physics, 2016) is applied, which differs for addition or subtraction (Eq. S7 and S8) and multiplication or division (Eq. S9 and S10).

If $y = c_1 \bar{x}_1 + c_2 \bar{x}_2 + \dots + c_k \bar{x}_k$ with $c > 0$ (addition) and $c < 0$ (subtraction) then:

$$\Delta y = \sqrt{(c_1 \Delta x_1)^2 + (c_2 \Delta x_2)^2 + \dots + (c_k \Delta x_k)^2} \quad \text{Eq. (S7)}$$

$$\text{and } RU_y = \Delta y / \bar{y} \quad \text{Eq. (S8)}$$

If $y = c \bar{x}_1^{m_1} \cdot \bar{x}_2^{m_2} \cdot \dots \cdot \bar{x}_k^{m_k}$ with $m > 0$ (multiplication) and $m < 0$ (division) then:

$$RU_y = \sqrt{(m_1 RU_1)^2 + (m_2 RU_2)^2 + \dots + (m_k RU_k)^2} \quad \text{Eq. (S9)}$$

$$\text{and } \Delta y = RU_y \cdot \bar{y} \quad \text{Eq. (S10)}$$

Note concerning data processing: if the standard deviation or the standard error is not available for a collected data set, then the uncertainty is set to be 30 % of mean value.

All calculations are performed in **Excel**. Data collection, data evaluation, and calculations of \dot{m} for all scenarios are combined in one file comprising various **spreadsheets** including:

- Summary of data on *process values*, collected from literature, such as transfer coefficients (TC) for nutrients during composting process, emissions after application of organic and mineral fertilisers, etc. (Table S32);
- Summary of data on *material values*, collected from literature, such as compositions of composts, densities of component materials, nutrient concentrations in kitchen waste, harvest products, and fertilisers, etc. (Table S32);
- Summary of *context specific data*, collected from the partner organisation and via expert judgement, such as size of cultivated land, fate of residual matter from harvesting of main crops, etc. (Table S32);
- Summary of *empiric data*, collected in a field experiment on the local Andosol using various soil amenders including those relevant for the present analysis, such as total above ground biomass production, yields of marketable products, yields of harvest residues, etc. (Table S32);
- Summary of *data for determining the NB* of the SNB, collected from literature and calculated (Table S27);
- Summary of *data on crop specific yields of and nutrient concentrations* in harvest products compiled from results of our own field experiment (see above) and values collected from literature. (Table S32);

- Calculations of \dot{m} related to SNB on separate spreadsheets for each sub-scenario AM1 to AM5; each spreadsheet is structured in two parts:
 1. 'Material and process values', comprising selected values from data collection, which are required for the calculations in this sheet (e.g. yields of and concentrations in harvest products, distribution of harvest residues, nutrient TCs for composting, etc.).
 2. 'Calculated material and nutrient flows', comprising calculations of all \dot{m}_{input} and \dot{m}_{output} of the PB on layers G, C, N, and P.
- Summaries and comparisons of results from the four scenarios, e.g. yields, fertiliser usage and application rates, estimated flows referring to the partial, natural, and full SNB, etc.
- Summary of selected plausibility criteria for crosschecking estimated values from our model with reliable data from literature sources.
- Diagrams presenting results.

1.4. Assumptions and simplifications in the AES-model.

Across the five scenarios, we took the following basic assumptions to simplify modelling:

- Local agriculture and crop cultivation is **rain-fed only**, and no irrigation is applied.
- Crops are **intercropped in lines**. Every season the arrangement of cropping lines on the plot is **rotated**.
- **Beans** are not included in the PB of N. As legume plants, beans take up N from the atmosphere. 100 % of N taken up by beans is assimilated from the air.
- 50 % of the total N contained in the total biomass of beans would be available next season through **BNF**.
- BNF is equally distributed to the whole *msiri* because beans are intercropped and crop positions rotate on the plot. The N-input through BNF to a certain crop is proportional to the share of land cultivated with that crop.
- Residues and grasses are used for **mulching** and **carpeting**, respectively, whereby matters are equally applied to the whole *msiri*. Thus, nutrient inputs are also evenly distributed on the total area.
- Due to the present semi-arid, tropical savannah climate, with year-round elevated temperatures, **composting** lasts for three to six months, or approximately one season (Landon, 1991).
- Compost produced in one season, is available in the next season. *Vice versa*, compost used in the present season was produced in the previous season. The amount of compost *produced* and that of compost *used* are thus comparable in each season, and defined as equivalent before the background that our model is static, not dynamic.
- **Application of both composts** is done once per year and, thus, the total amount of compost needed to cover the nutrient demands of crops in two cultivation periods is applied.
- According to Finck (2007), **100 % of the P contained in compost** is available for plants *in the long-run*. Hence, in the real-world, the demand of crops growing in a certain season will be covered from several soil amendments that had been applied during previous seasons. In our static model, however, compost applied in one year computationally meets nutrient demands of crops grown during the same year.
- **Application of biogas slurry** is done every season. In our static model, the application is depicted as an annual input of biogas slurry per square meter. In the real-world, however, application can be done in several doses, which should follow the different phase of nutrient requirements during plant growth. For maize, for example, nutrient demands are highest in the period between day 28 and 56 (weeks 4 to 8) after sowing (KTBL, 2009).
- **Application of urine** as mineral input is modelled following comparable assumptions to fertilizing with biogas slurry. Simplified static application of urine is modelled per year and per square meter.
- Nutrient inputs added by **seeds** are not considered.
- Most **flows of the NB** are assumed based on literature using data of studies in a comparable specific context. Only the BNF is calculated based on bean production and thus varies across scenarios.
- Soil and nutrient losses through **wind and water erosion** are not considered.

Table S27: Commented list of material flows and assumptions of SNB in AES-model.

Flow name		Subdivision		Information derived from literature review	Sources	Assumptions for the present study and comments on integration in system analysis
Input flows of the PB						
IN1	Mineral fertilizer	a	Synthetic fertilizer	Synthetic fertilizers are used on <1 % of the planted land in Kagera; no area being fertilized in Karagwe; farmers of Mavuno don't use synthetic fertilizers because of applied organic farming practice.	Mavuno, 2015; Tanzania, 2012	<ul style="list-style-type: none"> • Not considered.
		b	Ash	In Karagwe, ash is mainly deposited in heaps or thrown into pit latrines; sometimes used as reaction to declining soil fertility or to control pests. Farmers of Mavuno use ashes mainly for composting.	Baijukya et al., 1998; EfCoiTa, 2013; Mavuno, 2015; Rugalema et al., 1994	<ul style="list-style-type: none"> • Not considered as sole mineral input. • Ashes, from cooking and from burning harvest residues are considered as compost additive (→ IN2c or IN2d). • Available quantities from prior studies (Krause and Rotter, 2017).
		c	Urine	Can be considered as mineral fertilizer input.	Richert et al., 2010	<ul style="list-style-type: none"> • Urine considered as mineral fertilizer in addition to organic fertilizer to balance N-demand of crops. • Available quantities from prior studies (Krause and Rotter, 2017).
IN2	Organic input:	a	Grass carpet	One of main sources of organic fertilization in Karagwe. In most cases, grasses derived from grassland surrounding the homestead.	Baijukya et al., 1998; Tanzania, 2012	<ul style="list-style-type: none"> • Grasses considered as import material flow to the AES. • Share of residues used for burning estimated through expert judgement (Table A.5).
		b	Mulching with crop residues	One of main sources of organic fertilization in Karagwe.	Baijukya et al., 1998; Tanzania, 2012	<ul style="list-style-type: none"> • N- and P-recycling rates assumed based on collected data. • Total quantity of available crop residues from the model. • Share of residues used for mulching estimated through expert judgement (Table A.5).
		c	Standard compost	About 78 % of the farmers applying fertilizer in Kagera use organic fertilizer. However, compost is applied on only 5 % of the planted land in sum of both cultivation periods. Increasing number of farmers at Mavuno use standard compost as promoted by agricultural technicians.	Mavuno, 2014; Tanzania, 2012	<ul style="list-style-type: none"> • N- and P-recycling rates assumed based on collected data. • Production of compost from various available organic wastes as part of the model. • Composition of compost based on local practice (Krause et al., 2015).
		d	CaSa-compost	In the past, human excreta contributed to farm-scale nutrient recycling before implementation of pit latrines; e.g. it is common for farmers to deposit human excreta on each stool of banana on a rotating basis. Nowadays, a pilot project in Karagwe focuses on recovery of these resources through EcoSan approaches.	Baijukya et al., 1998; Krause et al., 2015; Rugalema et al., 1994	<ul style="list-style-type: none"> • Production of CaSa-compost from various available organic wastes as part of the model. • Composition of CaSa-compost based on practice in CaSa-project (Krause et al., 2015). • Quantities of treated toilet waste and nutrient contents from prior studies (Krause and Rotter, 2017).
		e	Biogas slurry	Available for households possessing a BiogaST-digester.	Krause et al., 2015	<ul style="list-style-type: none"> • Available quantity of biogas slurry produced per household and nutrient content in biogas slurry from prior studies (Krause and Rotter, 2017).
		f	Manure	In Karagwe, 15 % of household possess cattle and usually less than five animals. Hence, minor use of manure. Especially structural poor households practise farming without animal keeping.	Baijukya et al., 1998; Rugalema et al., 1994; Tanzania, 2012	<ul style="list-style-type: none"> • Not considered.

Input flows of the NB						
IN3	Atmospheric deposition	a	Wet (rain)	Related to precipitation; including N-fixation through lightening and formed NO _x dissolved in rainwater.	Lesschen et al., 2007	<ul style="list-style-type: none"> • Considered and estimated from mean value of literature data and own calculation after Lesschen et al., 2007 with an assumed mean annual precipitation of 900 dm³ m⁻².
		b	Dry (dust)	Related to Harmattan dust; only relevant in West Africa, hence not relevant in the specific context.	Lesschen et al., 2007 (Fig. 1)	<ul style="list-style-type: none"> • Not considered.
IN4	Biological nitrogen fixation (BNF)	a	Symbiotic	From leguminous species; BNF of beans is ~50 % of the total N taken up by the plant in above-ground biomass.	Baijukya et al., 1998; Lesschen et al., 2007; Stoorvogel et al., 1993	<ul style="list-style-type: none"> • Beans are only legume crop in the AES-model. • 50 % of N in total harvest product of beans accounted as BNF in the NB • N-uptake of beans excluded in the PB for N, because N derived from atmosphere.
		b	Non-symbiotic	From rainfall and N-fixing trees.	Lesschen et al., 2007 (Eq. 2)	<ul style="list-style-type: none"> • Mean value of results from Baijukya et al., 1998 and own calculations with formula in Lesschen et al., 2007.
		c	Non-symbiotic	N fixation by cyanobacteria as an important process in soils under wetland rice production.	Lesschen et al., 2007	<ul style="list-style-type: none"> • Not considered.
IN5	Sedimentation	a	Irrigation water	In Kagera, 0.8 % of the total land used for agriculture is irrigated, mainly for vegetables and only in the short rainy season. Local agriculture mainly rain-fed.	Tanzania, 2012	<ul style="list-style-type: none"> • Not considered.
		b	Sedimentation	erosion as input; see Out 5.		<ul style="list-style-type: none"> • Not considered.
IN6	Subsoil exploitation			Considered especially important in agroforestry systems.	Van den Bosch, 1998	<ul style="list-style-type: none"> • Not considered.
Output flows of the PB						
OUT 1+2	Harvest product			Total above ground biomass at time of harvesting including food products (OUT1a, b) and crop residues (OUT2a-d).		<ul style="list-style-type: none"> • Selected crops: maize, beans, onion, cabbage. • Yield estimations for all crops depend on fertilization. • Yield estimations based on literature review and own experiments (see Table A.3)
OUT1	Food products	a	Self-consumption	Food crops for consumption within farming household; nutrients remain on the farm and are potentially available for recycling through MSS.	Baijukya et al., 1998; Rugalema et al., 1994	<ul style="list-style-type: none"> • Average share of harvest products used for own consumption available from unpublished pre-studies (see Table A.1). • Nutrient content determined through data collection.
		b	Sold to market	Food crops for selling at the market for income generation; nutrients being exported from the farmland	Baijukya et al., 1998; Rugalema et al., 1994	<ul style="list-style-type: none"> • Average share of harvest products used for selling available from unpublished pre-studies (see Table A.1). • Nutrient content determined through data collection.
OUT2	Crop residues	a	Burnt	Burning of agricultural residues, which are removed from the field.	Lesschen et al., 2007; Mavuno, 2015	<ul style="list-style-type: none"> • 2 % of harvest residues are burnt; • 100 % of C and N in burnt matter emitted when burning, 100 % of P is recyclable with ashes → IN1c and IN2d; • Further emissions calculated based on Aalde et al., 2006. • 47 % of harvest residues are used for mulching → IN2a.
		b	Mulching	Agricultural residues remaining on the field as cover material; important practice to control evaporation of soil moisture in dry season.	Baijukya et al., 1998; Mavuno, 2015; Rugalema et al., 1994	
		c	Composting	Agricultural residues taken from the field and used for composting.	Mavuno, 2015	<ul style="list-style-type: none"> • 41 % of harvest residues are used for mulching → IN2b or IN2c.
		d	Exported	Given to animals as fodder, used as construction materials, dumped, sold, etc..	Mavuno, 2015	<ul style="list-style-type: none"> • 10 % of harvest residues are exported from AES; • Nutrients and carbon accounted as export flow from farmland.

Output flows of the NB						
OUT3	Leaching		Leaching of N and K can be an important outflow, which is quantified with regression models.	Lesschen et al., 2007	• Mean value of data collected from literature review.	
OUT4	Gaseous losses	a	Denitrification	Takes place under anaerobic conditions, e.g. on loamy soils under wet climate; mainly N ₂ O.	Lesschen et al., 2007	• Mean value of data collected from literature and own calculation after Eq. (5) in Lesschen et al., 2007.
		b	Volatilisation	Important in alkaline environments but is neglected on acidic soils.	Baijukya et al., 1998; Lesschen et al., 2007	• Not considered.
OUT5	Soil erosion	a	With wind	Baijukya et al., 1998 ‘considered (erosion) not important in perennial homegardens’; lack of sufficient data on slopes and erosion sensitivity of local soil; farmers in Karagwe apply erosion control measures such as trenches, mulching, intercropping with cover-crops, and agroforestry to control soil erosion; Mavuno strongly emphasizes implementation of erosion control measurements.	Baijukya et al., 1998; Mavuno, 2014; Tanzania, 2012	• Not considered.
		b	With water			
OUT6	Human excreta		Urine and faeces ending up in deep pit latrine	Since implementation of pit latrines in 1940s, urine and faeces are deposited in pit latrine, where nutrients are stored unavailable.	Baijukya et al., 1998; Rugalema et al., 1994; Smaling et al., 1996	• Considered as recycling flow with IN1c and IN2d.

Non-common abbreviations: AES: agroecosystem; BiogaST: project ‘Biogas support for Tanzania’; CaSa: project ‘Carbonization and Sanitation’; EcoSan: ecological sanitation; EfCoiTa: project ‘Efficient cooking in Tanzania’; MES: micro energy system; MSS: micro sanitation system; NB: natural balance; PB: partial balance; SNB: soil nutrient balance

Supplementary 2. SPECIFIC EQUATIONS APPLIED FOR MODELLING

In addition to the principle equations (Eq. A.1-A.6), we applied a set of equations which are explained in this chapter. In sum, equations are applied for following purposes:

1. To determine the NB for *msiri* (S2.1 and 2.2);
2. To determine the PB for *msiri*, (S2.5), which is based on:
 - a. Quantifying possible yields without fertilisation (AM1) and with fertilisers (AM3-AM5) (Section S2.3),
 - b. Quantifying the amounts of organic and mineral inputs (S2.4);
3. To model the composting process for two different kinds of compost (S2.6).

Note: Material flows are generally abbreviated following the concept of SNB with some adoptions specifically for the present model (Table A.3. and Table 5 in the main article). The layer of modelling is indicated by the first index after the variable (e.g. $OUT1_p$ as flow of P in OUT1).

2.1. Output flows of the natural balance.

The \dot{m}_{output} of the NB includes losses through **leaching** of liquids and dissolved nutrients ($OUT3$) along with **gaseous losses** through denitrification ($OUT4a$) which are quantified through literature review (Table S27). From the data collected, we deduced mean values of \dot{m}_{OUT3} and \dot{m}_{OUT4a} in $\text{kg ha}^{-1} \text{yr}^{-1}$, which are extrapolated by applying:

$$OUT3 = \dot{m}_{OUT3} \cdot area_{msiri} \quad \text{Eq. (S11)}$$

$$OUT4a = \dot{m}_{OUT4a} \cdot area_{msiri} \quad \text{Eq. (S12)}$$

Both \dot{m}_{output} are calculated for the layer of N only.

2.2. Input flows of the natural balance.

The \dot{m}_{input} of the NB includes **atmospheric wet deposition** ($IN3a$) and **asymbiotic N fixation** ($IN4b$), which are quantified by reviewing literature (Table S27). Literature provided general values for \dot{m}_{IN3a} and \dot{m}_{IN4b} in $\text{kg ha}^{-1} \text{yr}^{-1}$, which are extrapolated by applying:

$$IN3a = \dot{m}_{IN3a} \cdot area_{msiri} \quad \text{Eq. (S13)}$$

$$IN4b = \dot{m}_{IN4b} \cdot area_{msiri} \quad \text{Eq. (S14)}$$

The $IN3a$ is calculated for layers N and P whilst $IN4b$ is only relevant to the layer of N.

In addition, N-input through **symbiotic BNF** ($IN4a$) is calculated. Thereby, we assumed that 50 % of the N-uptake of the plant, distributed to the bean ($OUT1_{N,beans}$), to straw ($OUT2_{N,beans,straw}$), and to leaves ($OUT2_{N,beans,leaves}$), contributes to NB:

$$IN4a = 0.5 \cdot (OUT1_{N,beans} + OUT2_{N,beans,straw} + OUT2_{N,beans,leaves}) \quad \text{Eq. (S15)}$$

2.3. Output flows of the partial balance.

The \dot{m}_{output} of the PB include (i) total biomass production, (ii) nutrient uptake of selected crops, (iii) gaseous emissions from the application of fertilizers, and (iv) gaseous emissions from burning agricultural residues.

2.3.1. Biomass production

The total biomass comprises food products (OUT1) and harvest residues (OUT2). Furthermore, food products are used to contribute to the food supply and incomer generation of the farming family. Therefore, we consider a share of food product harvested as being used for self-consumption (OUT1a) and the rest as being sold at local markets or to intermediaries (OUT1b). The respective distribution of total food products has been assessed during pre-studies of this work in 2010 and via questionnaire (Table S28).

Table S28: Use of the harvested food product.

Crop	Self consumption (frac _{sc})	Sold to market
Maize	66%	34%
Beans	38%	62%
Onion	100%	0%
Cabbage	100%	0%

Note: In the main article, only results for the total harvest of food products (OUT1) are presented and discussed. Further discussion of results for OUT1a and OUT1b is included in the synthesis of the dissertation of Ariane Krause and discussed in the context of food security for smallholders in Karagwe³.

The **total \dot{m}_{output} of food products** (OUT1) is first calculated for each crop (Eq. S16) and then summed up for all four crops (Eq. S17).

$$OUT1_{G,maize} = MF \cdot LU_{maize} \cdot Y_{FP,maize} \cdot 1000 \quad \text{Eq. (S16)}$$

Exemplarily shown for determining the total production of food products of maize (OUT1_{G,maize} in kg yr⁻¹) by using the model factor (MF), the factor describing land used for maize cultivation (LU_{maize}) and the specific yield of food products for maize ($Y_{FP,maize}$ in t ha⁻¹ season⁻¹). Flows of OUT1 for the other crops are calculated accordingly by using the crop-specific values for LU and Y.

$$OUT1_{G,total} = OUT1_{G,maize} + OUT1_{G,beans} + OUT1_{G,onion} + OUT1_{G,cabbage} \quad \text{Eq. (S17)}$$

Subsequently, food products are distributed to OUT1a and OUT1b by using the variable indicating the crop-specific fraction of the harvest used for self-consumption ($frac_{SC,maize}$) and the following equations:

$$OUT1a_{G,maize} = OUT1_{G,maize} \cdot frac_{SC,maize} \quad \text{Eq. (S18)}$$

$$OUT1b_{G,maize} = OUT1_{G,maize} - OUT1a_{G,maize} \quad \text{Eq. (S19)}$$

Exemplarily shown for maize; the flows OUT1a and OUT1b for the other crops can be calculated accordingly by using the crop-specific values for frac_{sc} (see Table S28).

The total **\dot{m}_{output} of harvest residues** (OUT2) is calculated in the same way as OUT1. Thus, we applied Eq. S16 and S17 but with crop-specific values for yields of harvest residues ($Y_{HR,maize}$ in t ha⁻¹ season⁻¹) (Table S32).

Finally, we consider the **use of harvest residues** according to local practices:

$$OUT2b_G = OUT2_G \cdot frac_{mulching} \quad \text{Eq. (S20)}$$

Exemplarily shown for harvest residues used for mulching (OUT2b_G in kg yr⁻¹) by using the total amount of available harvest residues (OUT2_G) and the factor describing the use of harvest residues for mulching ($frac_{mulching}$). The other \dot{m}_{output} for burnt, composted, or other purposes can be calculated accordingly by using, respectively, $frac_{burning}$, $frac_{composting}$, or $frac_{others}$.

Information on the fate of harvest residues has been collected through expert judgement (Mavuno, 2015) and is presented in Table S29. Residues are burnt (OUT2a), recycled to the AES by using them for mulching (OUT2b), composted (OUT2c), or exported (OUT2d). The first flow is divided into emissions to the atmosphere (OUT2a_{emission}) and ashes remaining after incineration (OUT2a_{ash}). The OUT2a_{emission} is an *export flow* (see S2.3.IV) whilst OUT2a_{ash} is a *recycling flow* because ashes are added to the compost (see S2.4.). Flow OUT2d includes harvest residues that are dumped (outside the farmland), used as construction material, thrown in toilet, sold, etc.

³ The dissertation titled 'Valuing wastes - An Integrated System Analysis of Bioenergy, Ecological Sanitation, and Soil Fertility Management in Smallholder Farming in Karagwe, Tanzania' will be published at *DepositOnce*, the repository for research data and publications of TU Berlin during 2018.

Table S29: Fate of the harvest residues determined through expert judgement (Mavuno, 2015).

Flow name	Use of residue	Unit	Mean	Error	Uncertainty
OUT2a	Burning	% FM	0.02	± 0.01	48%
OUT2b	Composting	% FM	0.41	± 0.07	16%
OUT2c	Mulching	% FM	0.47	± 0.07	14%
OUT2d	Others	% FM	0.10	± 0.03	27%

2.3.2. Nutrient uptake of crops

The total \dot{m}_{output} of N and P contained in **food products and harvest residues** are calculated from the total production in the G-layer (OUT1_G and OUT2_G, respectively) and by using the concentration (c) of nutrients in the products. Values of nutrient concentrations are based on data from literature and own results (Krause et al., 2016) (Table S32).

$$OUT1_{N,maize} = OUT1_{G,maize} \cdot c_{FP,maize,N} \quad \text{Eq. (S21)}$$

Exemplarily displayed for N in total food product of maize (OUT1_{N,maize}) with $c_{FP,maize,N}$ being the concentration of N in the total food product (FP) of maize in % (FM).

$$OUT2_{N,maize} = OUT2_{G,maize} \cdot c_{HR,maize,N} \quad \text{Eq. (S22)}$$

Exemplarily displayed for N in total harvest residues of maize (OUT2_{N,maize}) with $c_{HR,maize,N}$ being the concentration of N in the total harvest residues (HR) of maize in % (FM).

Then, total nutrient exports for all crops are estimated by applying Eq. 17 to layers N and P (e.g. OUT1_{N,total} or OUT2_{P,total}). The total \dot{m}_{output} of nutrients with harvest residues is further distributed among the several usages of the harvest residues by applying Eq. 20 to derive, for example OUT2c_N, or OUT2b_P for mulching or composting, respectively.

2.3.3. Gaseous emissions from fertiliser applications

When adding fertilizers on managed soils, volatilization, nitrification, and denitrification processes occur which lead to emissions of N₂O- and NH₃-gases (e.g. De Klein et al., 2006). Our model considers \dot{m}_{output} of N through **N₂O- and NH₃-emissions after the addition of carpeting grasses, mulching material, urine, or biogas slurry**. N₂O- and NH₃-emissions are represented in the NB as flow OUT4a (Table S27). Furthermore, these emissions which reduce N-content in input matter, are accounted for by estimating a nutrient specific recycling-rate in percentage of the total nutrient input. For example, approximately 87 % of the total N contained in grasses used for carpeting will be recycled into the soil to be available for fertilization. The recycling-rate is considered in calculations of the \dot{m}_{input} of the fertilizers required and are, thus, integrated in the equations explained in S2.4. Soil-borne CH₄ and CO₂ emissions from liming (De Klein et al., 2006) are not considered for simplification due to specific data gaps for the local soil. Possible **emissions after compost amendments are also not considered** because, according to Möller and Stinner (2009) NH₃-emissions depend on the NH₄-content. The latter is not commonly found in solid compost, which is also the case for both composts analysed (Krause et al., 2015).

2.3.4. Gaseous emissions from burning agricultural residues

Emissions from burning agricultural residues comprise CO₂, CO, CH₄, N₂O, and NO_x. These gaseous emissions are determined following Aalde et al. (2006), who provide emission factors (EF) in g kg⁻¹ of DM of burnt residues.

$$OUT2a_{G,emission,CO2} = OUT2a_G \cdot c_{HR,DM} \cdot EF_{CO2} \quad \text{Eq. (S23)}$$

Exemplarily displayed for CO₂-emissions (OUT2a_{emission,CO2}) from burning harvest residues (OUT2a_G) with $c_{HR,DM}$ being the concentration of dry matter (DM) in the total harvest residues (HR) and EF_{CO2} being the emission factor for CO₂. The other emissions are calculated accordingly with the specific EF, e.g. EF_{CO} , EF_{CH4} , etc.

Furthermore, we assumed that 100 % of total C and total N in the burnt matter is emitted to the atmosphere during incineration (Lesschen et al., 2007) whilst 100 % of P is recovered in ashes.

$$OUT2a_{C,ashes} = OUT2a_{N,ashes} = 0 \quad \text{Eq. (S24)}$$

$$OUT2a_{P,ashes} = OUT2a_P \quad \text{Eq. (S25)}$$

2.4. Input flows of the partial balance.

To realise sustainable crop production and soil management, the total nutrient requirements of crops need to be balanced by inputs of nutrients. In our model, nutrients are provided with the following \dot{m}_{input} :

- Grass carpeting on the whole plot as standard practice in AM1-5,
- Mulching with crop residues on the whole plot as standard practice in AM1-5,
- Biogas slurry amendment for maize and beans in AM2,
- Compost amendment for vegetables in AM1-5 (in AM1 only for cabbage),
- CaSa-compost amendment for maize and beans in AM3-5, and
- Mineral fertilization with urine for all crops in AM2-5.

2.4.1. Organic input: carpeting and mulching

To reduce evapotranspiration of water in soil during the dry seasons and to avoid soil erosion by wind, it is a common local practice to cover the topsoil with (i) a carpet of grasses and (ii) a layer of mulch prepared from harvest residues. Carpeting with grasses is usually made at the end of the rainy season, before the dry season starts. Mulching is done at the time when agricultural residues accumulate, which is after harvesting or after drying of harvest products. Thus, mulching is usually done *before* planting and as part of the plot preparation while carpeting is done *after* planting and during the cultivation period. However, as our model is static, the time of application does not matter.

The total \dot{m}_{input} of **carpeting material** ($IN2a_G$) is estimated based on an annual use of grasses in fresh-matter ($\dot{m}_{grass\ carpet,FM}$) and in kg ha⁻¹ yr⁻¹ as typical for the region (Table S32):

$$IN2a_G = \dot{m}_{grass\ carpet,FM} \cdot area_{msiri} \quad \text{Eq. (S26)}$$

We further assume that 100 % of P contained in grasses is available to growing plants ($IN2a_P$), and thus:

$$IN2a_P = IN2a_G \cdot c_{grass,P} \quad \text{Eq. (S27)}$$

With the amount of carpeting grasses applied in FM ($IN2a_G$) and the concentration of P in FM of grasses in % ($c_{grass,P}$).

However, \dot{m}_{input} of N with carpeting ($IN2a_N$) is lower than the total N contained in the grasses because of gaseous emissions (S2.3.III). Following Larsson et al. (1998) and Schmidt (1997), we consider that 11.5 ± 3.0 % of the total N would be lost through NH₃-emissions. In addition, Larsson et al. (1998) and Möller and Stinner (2009) assume that on average, 1.6 ± 0.3 % of the total N is transferred to N₂O-emissions. Thus, in total, 87 ± 3 % of the total N contained in grasses or mulching material ($frac_{rec.,grass,N}$) is recycled, and thus available to plants. We recognize this with:

$$IN2a_N = IN2a_G \cdot c_{grass,N} \cdot frac_{rec.,grass,N} \quad \text{Eq. (S28)}$$

With the applied FM of grass used for carpeting ($IN2a_G$) and the concentration of N in FM of grasses in % ($c_{grass,N}$) and the fraction of N being effectively recycled to the AES from total N contained in the grasses ($frac_{rec.,grass,N}$).

The total \dot{m}_{input} of **matter used for mulching** ($OUT2b_G$) depends on yields of harvest residues (S2.3.I) and the share of agricultural residues used for mulching (Table S29).

To determine nutrient inputs with harvest residues, we consider gaseous losses from soil management in the same way as carpeting. First, we assume that 100 % of P contained in mulching material is recycled:

$$IN2b_P = OUT2c_P \quad \text{Eq. (S29)}$$

With the total input of P with mulching material ($IN2b_P$) and the total P contained in harvest residues used for mulching ($OUT2c_P$) (Table S29).

Then, \dot{m}_{input} of N with mulching ($IN2b_N$) considers gaseous emissions after applying the matter (S2.3.III) and is thus reduced compared to the total N contained in harvest residues used for mulching ($OUT2b_N$):

$$IN2b_N = OUT2b_N \cdot frac_{rec.,mulching,N} \quad \text{Eq. (S30)}$$

With the total N applied with harvest residues used for mulching ($IN2b_N$) and the fraction of N being effectively recycled to the AES from total N contained in the harvest residues ($frac_{rec.,mulching,N}$).

We further assume that recycling-rates for N are comparable for carpeting and mulching.

$$frac_{rec.,grass,N} = frac_{rec.,mulching,N} \quad \text{Eq. (S31)}$$

In addition, we assume that materials used for carpeting and mulching are equally applied to the whole *msiri*. Thus, we assign \dot{m}_{input} of nutrients to specific crops according to the LU, respectively, which becomes relevant to determine \dot{m}_{input} of organic and mineral fertilizers.

2.4.2. Organic input: biogas slurry

According to our fertilization strategy (S1.3), the total amount of organic input is **based on crops' P-requirements** after carpeting and mulching. Hence in AM2, the total \dot{m}_{input} of P with biogas slurry, for cultivating maize and beans, is calculated with:

$$IN2e_{P,maize} = OUT1_{P,maize} + OUT2_{P,maize} - (IN2a_P + IN2b_P) \cdot LU_{maize} \quad \text{Eq. (S32)}$$

Exemplarily displayed for maize; for beans, the calculation is done accordingly. With the factor indicating the land used for cultivating maize in % of the total *msiri* (LU_{maize}).

From this, the **crop-specific total \dot{m}_{input} of biogas slurry** is deduced with:

$$IN2e_{G,maize} = IN2e_{P,maize} / c_{biogas\ slurry,P} \quad \text{Eq. (S33)}$$

Exemplarily displayed for maize; for beans, the calculation is done accordingly. With the concentration of P in FM of biogas slurry in % ($c_{biogas\ slurry,P}$).

Then, the **total \dot{m}_{input} of biogas slurry** to land planted with maize and beans is calculated with:

$$IN2e_{G,total} = IN2e_{G,maize} + IN2e_{G,beans} \quad \text{Eq. (S34)}$$

Exemplarily displayed for the layer of G; the total nutrient input is determined accordingly for layers N and P.

The **total input of N considers N-losses** after the application of fertilizer. Following Amon et al. (2006) and Möller and Stinner (2009), we assume that 13.9 ± 2.2 % of the total N is lost through NH_3 -emissions. In addition, 0.9 ± 0.2 % of the total N is lost through N_2O -emissions (*ibid.*) and 4.1 ± 1.5 % of the total N is lost through nitrate leaching (Prasertsak et al., 2001). Thus, in total, 81 ± 3 % of the total N contained in biogas slurry ($frac_{rec.,biogas\ slurry,N}$) is finally available to crops as $IN2e_N$. Given that beans derive N through BNF, we assume that the total N in biogas slurry can be consumed by maize plants ($IN2e_N = IN2e_{N,maize}$).

$$IN2e_{N,maize} = IN2e_{G,maize} \cdot c_{biogas\ slurry,N} \cdot frac_{rec.,biogas\ slurry,N} \quad \text{Eq. (S35)}$$

With the total amount of biogas slurry applied to the land planted with maize and beans ($IN2e_{G,maize}$), the concentration of N in FM of biogas slurry in % ($c_{biogas\ slurry,N}$), and the fraction of N being effectively recycled to the AES from total N contained in the biogas slurry ($frac_{rec.,biogas\ slurry,N}$).

Finally, we compare if \dot{m}_{input} of biogas slurry required can be covered with the available residues from the MES: $IN2e_{G,total} \leq \dot{m}_{biogas\ slurry\ available}$. If $IN2e_{G,total} \geq \dot{m}_{biogas\ slurry\ available}$, then $IN2e_{G,total}$ is manually decreased to $IN2e_{G,total} = \dot{m}_{biogas\ slurry\ available}$.

2.4.3. Organic input: standard compost

To determine **\dot{m}_{input} of P with standard compost** we also consider P-requirements of the vegetables after carpeting and mulching:

$$IN2c_{P,cabbage} = OUT1_{P,cabbage} + OUT2_{P,cabbage} - (IN2a_P + IN2b_P) \cdot LU_{cabbage} \quad \text{Eq. (S36)}$$

Exemplarily displayed for cabbage; calculations for onion completed accordingly with the LU-factor for cabbage in % of the total *msiri* ($LU_{cabbage}$).

From this, the \dot{m}_{input} of standard compost to cabbage or onion is deduced with:

$$IN2c_{G,cabbage} = IN2c_{P,cabbage} / c_{compost,P} \quad \text{Eq. (S37)}$$

Exemplarily displayed for cabbage; calculations for onion accordingly. With concentration of P in standard compost in % of FM ($c_{compost,P}$).

Then, the total \dot{m}_{input} of standard compost to land planted with cabbage and onion is calculated:

$$IN2c_{G,total} = IN2c_{G,cabbage} + IN2c_{G,onion} \quad \text{Eq. (S38)}$$

Note: standard compost is only applied to cabbage in AM1, and to cabbage and onion in AM2-AM5.

As already explained (S2.3.III), we do not consider any **N-losses** after the amendment of compost. Hence:

$$IN2c_{N,cabbage} = IN2c_{G,cabbage} \cdot c_{compost,N} \quad \text{Eq. (S39)}$$

Exemplarily displayed for cabbage; calculations for onion completed accordingly with concentration of N in standard compost in % of FM ($c_{compost,N}$).

Finally, we compare whether \dot{m}_{input} of the standard compost required can be covered with compost produced:

$$IN2c_{G,total} \leq \dot{m}_{compost\ available} \cdot \text{If } IN2c_{G,total} \geq \dot{m}_{compost\ available}, \text{ then } IN2c_{G,total} \text{ is manually decreased to } IN2c_{G,total} = \dot{m}_{compost\ available}.$$

2.4.4. Organic input: CaSa-compost

The total \dot{m}_{input} of CaSa-compost ($IN2d_{G,total}$) to maize and beans is determined in a comparable way as described above for biogas slurry. However, for CaSa-compost we also assumed that no N-losses occur after the soil amendment so that 100 % of the total N contained in CaSa-compost are plant-available. Thus, the calculation of $IN2d_N$ followed Eq. S39 rather than Eq. S35 with concentration of N in CaSa-compost in % of FM ($c_{CaSa-compost,N}$).

2.4.5. Mineral input: urine application

To balance N after organic amendments, urine is used as an additional mineral fertilizer input. Associated with the use of urine as fertilizer, N-losses are assumed to be comparable to those occurring when using synthetic mineral fertilizers. Ammonia volatilisation after fertilisation with urine is thus assumed to be 7.3 ± 1.7 % of the total N in urine (Jönsson, 2002; Prasertsak et al., 2001; Rodhe et al., 2004), whilst N_2O emissions are 0.9 ± 0.2 % of total N (Amon et al., 2006; Möller and Stinner, 2009). In addition, 4.1 ± 1.5 % of the total N is lost through nitrate leaching (Prasertsak et al., 2001). Thus, in total, 88 ± 2 % of the total N contained in urine ($frac_{rec,urine,N}$) is finally available to crops as $IN1c_N$. Because crops have different nutrient demands, the model determines application rates of urine ($IN1c_G$) [in $dm^3 yr^{-1}$] separately for the areas of maize, beans, cabbage and onions respectively. However, the N-demand determined for the area planted with maize and beans is equivalent to N-demand of maize because beans are legume plants, performing BNF.

$$IN1c_G = \frac{(IN2e_N - OUT1_{N,maize} - OUT2_{N,maize} + (IN2a_N + IN2b_N + IN4a_N) \cdot LU_{maize}) \cdot 1000}{c_{urine,N} \cdot frac_{rec,urine,N}} \quad \text{Eq. (S40)}$$

Exemplarily displayed for the area planted with maize and beans in scenario AM2. With N in biogas slurry applied ($IN2e_N = IN2e_{N,maize} + IN2e_{N,beans}$; N-demand for food products ($OUT1_{N,maize}$) and harvest products ($OUT2_{N,maize}$); N-inputs with carpeting ($IN2a_N$), mulching ($IN2b_N$) and BNF ($IN4a_N$); LU-factor for maize in % of the total *msiri* (LU_{maize}), the concentration of N in fresh matter of urine in $kg\ dm^{-3}$ ($c_{urine,N}$); and the fraction of N being effectively recycled to the AES from total N contained in the urine ($frac_{rec,urine,N}$).

Then, total \dot{m}_{input} of N and P are determined by using the concentration of nutrients in urine. For N, a N losses are considered once again; respectively the fraction of N recycled to the AES is applied:

$$IN1c_N = IN1c_G \cdot c_{urine,N} \cdot frac_{rec,urine,N} \quad \text{Eq. (S41)}$$

$$IN1c_P = IN1c_G \cdot c_{urine,P} \quad \text{Eq. (S42)}$$

2.5. Synthesis: calculating the partial balances and the full soil nutrient balances.

In more detail as compared to the general equations presented in S1.3, the nutrient balances are finally estimated as follows.: Grass carpeting and mulching with residues are considered local standard practices and are therefore included as organic IN into ‘PB I without fertilization’ (Eq. S2). It follows, therefore, that PB I reflects the ‘net nutrient requirements’ of crops. Application of organic and mineral fertilizers are considered in ‘PB II with organic fertilization’ (Eq. S3), and ‘PB III with organic and mineral fertilization’ (Eq. S4), respectively. Organic and mineral INs are quantified based on the net nutrient requirements calculated in PB I (S2.4). Finally, ‘full SNB I with organic fertilization’ (Eq. S5) and ‘full SNB II with organic and mineral fertilization’ (Eq. S6) are calculated.

The net nutrient requirements, or ‘PB I without fertilization’ are in all scenarios:

$$PBI_N = \frac{IN2a_N + IN2b_N - OUT1_{N,maize} - OUT2_{N,maize} - OUT1_{N,onion} - OUT2_{N,onion} - OUT1_{N,cabbage} - OUT2_{N,cabbage}}{0.125 \text{ ha}} \quad \text{Eq. (S43)}$$

$$PBI_P = \frac{IN2a_P + IN2b_P - OUT1_{P,total} - OUT2_{P,total}}{0.125 \text{ ha}} \quad \text{Eq. (S44)}$$

The PB II with organic fertilization in scenario AM1 is:

$$PBII_N = PBI_N + \frac{IN2c_{N,total}}{0.125 \text{ ha}} \quad \text{Eq. (S45)}$$

$$PBII_P = PBI_P + \frac{IN2c_P}{0.125 \text{ ha}} \quad \text{Eq. (S46)}$$

with $IN2c_{N,total} = IN2c_{cabbage}$ because the only organic input is compost applied to the land planted with cabbage.

Finally, the PB III with organic *and* mineral fertilization in scenario AM1 is comparable to PBII because no urine is used as a mineral input in AM1:

$$PBIII_N = PBII_N \quad \text{Eq. (S47)}$$

$$PBIII_P = PBII_P \quad \text{Eq. (S48)}$$

The PB II with organic fertilization in scenario AM2 is:

$$PBII_N = PBI_N + \frac{IN2c_{N,total} + IN2e_{N,total}}{0.125 \text{ ha}} \quad \text{Eq. (S49)}$$

$$PBII_P = PBI_P + \frac{IN2c_P + IN2e_P}{0.125 \text{ ha}} \quad \text{Eq. (S50)}$$

Finally, the PB III with organic *and* mineral fertilization in scenario AM2 is:

$$PBIII_N = PBII_N + \frac{IN1c_{N,total}}{0.125 \text{ ha}} \quad \text{Eq. (S51)}$$

$$PBIII_P = PBII_P + \frac{IN1c_{P,total}}{0.125 \text{ ha}} \quad \text{Eq. (S52)}$$

with $IN1c_{N,total} = IN1c_{N,maize} + IN1c_{onion\&cabbage}$

The PB II with organic fertilization in scenarios AM3-5 are:

$$PBII_N = PBI_N + \frac{IN2c_{N,total} + IN2d_{N,total}}{0.125 \text{ ha}} \quad \text{Eq. (S53)}$$

$$PBII_P = PBI_P + \frac{IN2c_P + IN2d_P}{0.125 \text{ ha}} \quad \text{Eq. (S54)}$$

with $IN2c = IN2c_{cabbage\&onion}$ and $IN2d = IN2d_{maize\&beans}$

Finally, the PB III with organic *and* mineral fertilization in scenarios AM3-5 are:

$$PBIII_N = PBII_N + \frac{IN1c_N}{0.125 \text{ ha}} \quad \text{Eq. (S55)}$$

$$PBIII_P = PBII_P + \frac{IN1c_P}{0.125 \text{ ha}} \quad \text{Eq. (S56)}$$

with $IN1c = IN1c_{maize} + IN1c_{onion\&cabbage}$

2.6. Composting process.

In addition to those flows which are relevant for the SNB, we also modelled the composting process. For composting, various organic and organo-mineral materials are mixed (Figure S10 and S6) for subsequent bio-chemical metabolisms. Several decomposition and conversion processes result in the creation of the compost product as well as in gaseous (CO_2 , N_2O , NH_3) and liquid (P-leaching) emissions that occur during composting. Based on literature values for specific emissions, we estimated TCs for nutrients, including ‘N to gaseous emissions’, ‘N to compost’, ‘P to leachate’, and ‘P to compost’ (Table S32). Compositions of compost are assumed based on local practices introduced in Krause et al. (2015) used for standard- and CaSa-composting. Characteristics of various materials used as well as of the products, such as water contents, nutrient concentrations, densities, etc. are collected from literature and complemented by own empiric data (Table S32). In scenarios AM3-5, both, standard composting and CaSa-composting, are part of the modelling. Hence, the total matter composed of harvest residues available for composting ($\text{OUT}2c$), ash from burning harvest residues ($\text{OUT}2a_{ash}$), and kitchen waste are distributed to either of both composting practices by using defined TCs.

2.6.1. Standard composting

The standard compost, which is commonly prepared by local farmers, contains a mixture of fresh and dried grasses, ashes, and kitchen waste (Krause et al., 2015). In addition, water is added - if available - to improve the moisture content of the mixture. Topsoil is also added to introduce microorganisms. Composting is done in batches, which are often placed in a shallow pit in the ground and covered with soil and grasses to mitigate evaporation, and lasts for about three to six months. The figure S10 shows a flow diagram indicating how standard composting is depicted in our model with material flows indicated by arrows and the composting process as a box.

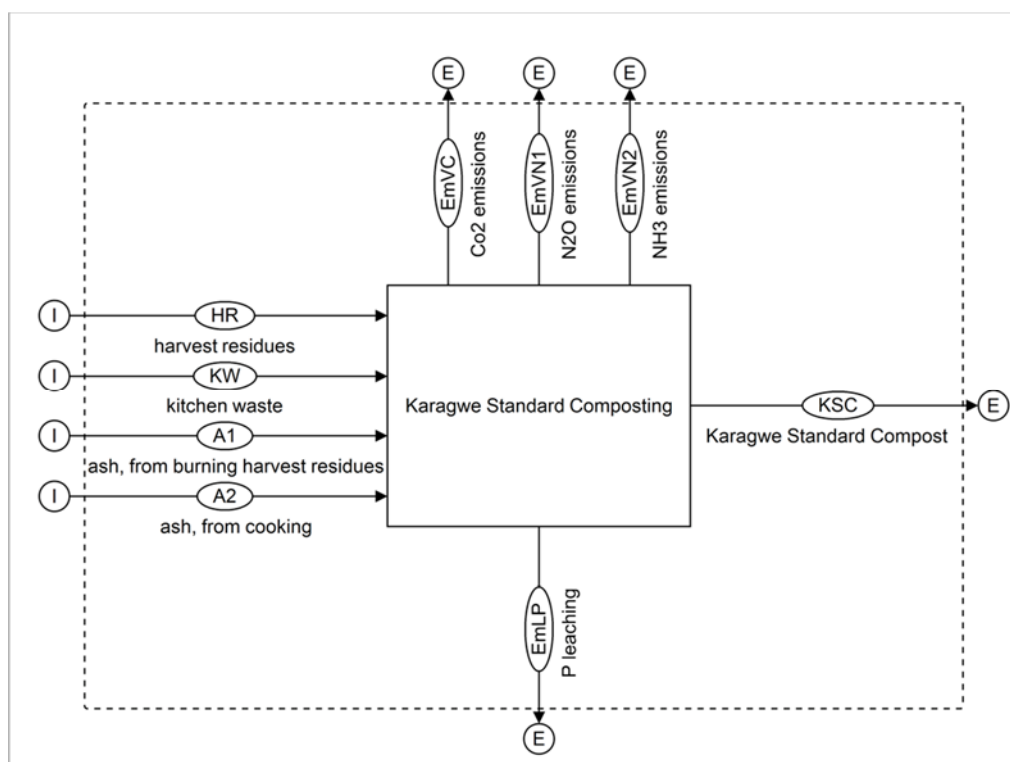

Figure S10: In- and output flows of materials to the Karagwe standard composting process.

$$Compost_{G,input} = HR_G + KW_G + A1_G + A2_G \quad \text{Eq. (S57)}$$

With $Compost_{G,input}$ as the sum of material used as input matter for composting, including harvest residues (HR), kitchen waste (KW), ash from burning harvest residues (S1), and ash from cooking (S2).

Ashes from cooking are only added to the composting in scenario AM1. Scenarios AM2-5 represent a shift in bioenergy technologies so that biogas digesters and burners (AM2) or microgasifiers (AM3-5) are used instead of three-stone fires (AM1). Hence, residues recovered from cooking include biogas slurry, which is used as direct organic input (IN2e), or biochar, which is used as an additive to CaSa-composting (S2.6.II). In scenarios AM3-5, CaSa-composting is more a part of the model, which requires distributing available input materials to both composting processes. Hence, in scenarios AM2 and AM3-5, Eq. S57 is adapted to Eq. S58 and S59, respectively.

$$Compost_{G,input} = HR_G + KW_G + A1_G \quad \text{Eq. (S58)}$$

$$Compost_{G,input} = (HR_G + KW_G + A1_G) \cdot frac_{compost} \quad \text{Eq. (S59)}$$

With $frac_{compost}$ as the TC of input matter available used for standard composting.

The production of compost ($Compost_{G,product}$) is also modelled by using TCs ($frac_{product,input,G}$) in all layers:

$$Compost_{G,product} = Compost_{G,input} \cdot frac_{product,input,G} \quad \text{Eq. (S60)}$$

Exemplarily shown on the layer G, equation is applied for layers C, N, P accordingly. $frac_{product,input,G}$ is the fraction of total input matter ($Compost_{G,input}$) being effectively transferred to the compost product ($Compost_{G,product}$) in % of $Compost_{G,input}$ on the layer G.

2.6.2. CaSa-composting

The CaSa-compost is made following the example of human-made *Terra Preta* soils, which are found in the Amazon Basin in South America, and are prominent for their outstanding fertility (Sombroek, 1966). Terra Preta production evolved centuries ago, and it is most probably the product of managing wastes and soil jointly. CaSa-composting, thus, includes co-composting of harvest residues, kitchen waste, ashes, biochar, pasteurised human faeces, □stored urine, soil, and sawdust (Krause et al., 2015). Urine, as a locally available resource, is added (i) to increase the moisture of the compost (and thus to replace frequent watering of the compost pit) and (ii) to enrich CaSa-compost with N. According to local practices, after storing urine for a minimum one month in a UDDT, the stored urine is mixed with biochar and/or sawdust prior to addition. This is done to balance the high addition of N to the compost with additional C input because biochar and woody sawdust are rich in C. Balancing the ratio of N/C in the compost mixture is important to maintain the composting process. Commonly, terracotta particles are also added to improve the physical structure and water retention of the product. Additions of C or other nutrients are, however, of minor relevance for the input of terracotta, or brick particles and, thus, the respective input flow is not depicted in our model. In Karagwe, CaSa-composting is done in a similar way to the standard composting, which means it takes place in batches placed in a shallow pit in the ground, covered with soil and grasses to mitigate evaporation, and lasts for about three months. □The figure A.6 shows a flow diagram indicating how CaSa-composting is depicted in our model with material flows indicated by arrows and the composting process as a box.

Determining the sum of materials used as input matters for CaSa-composting ($CaSa - Compost_{G,input}$) is equivalent to Eq. S57, but all input flows are indicated by arrows on the left side of Fig. S11. The distribution of matters to CaSa-composting is done pursuant to Eq. S59 and with

$$frac_{CaSa-compost} = 1 - frac_{compost} \quad \text{Eq. (S61)}$$

Precisely, we assumed that $70 \pm 7\%$ of $OUT2c$, $OUT2a_{ash}$, or kitchen waste are utilized via CaSa-composting ($frac_{CaSa-compost}$) whilst $30 \pm 3\%$ of $OUT2c$, $OUT2a_{ash}$, or kitchen waste are utilized via standard composting ($frac_{compost}$).

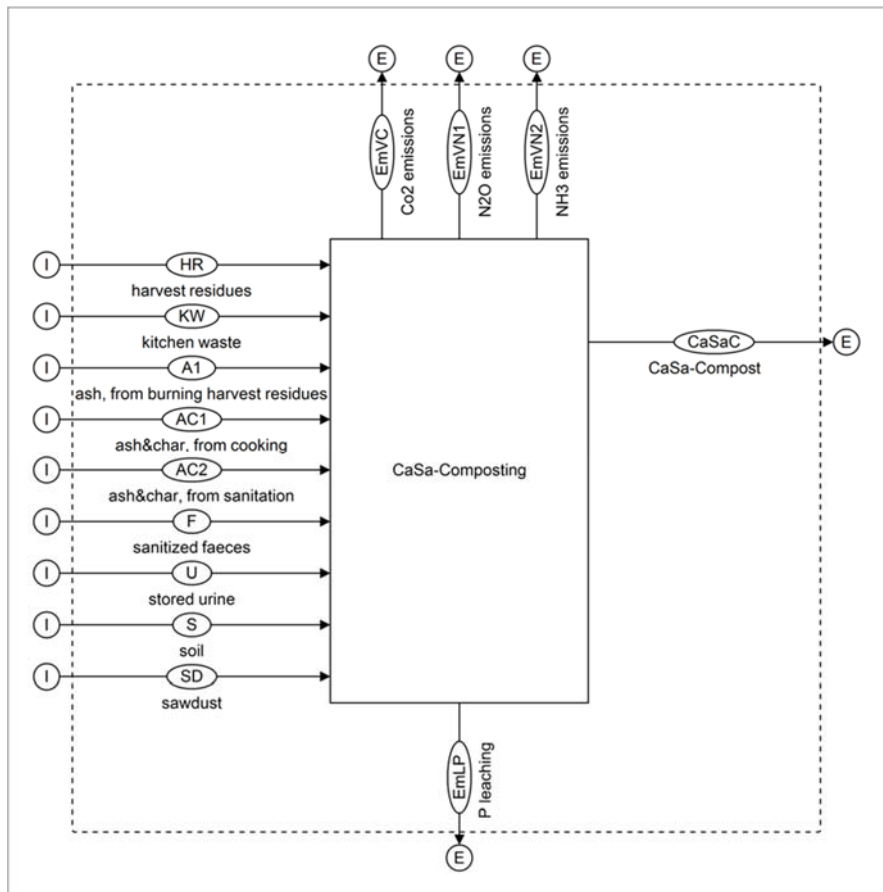

Figure S11: In- and output flows of materials to the CaSa-composting process.

The production of CaSa-compost ($CaSa-compost_{G,product}$) is also modelled by using TCs ($frac_{product,input,G}$) on all layers and pursuant to Eq. S60. Only for the transfer of C, are the calculations adapted because we assumed that 100 % of the C contained in biochar is transferred to the $CaSa-compost_{G,product}$.

Supplementary 3. ASSESSMENT OF EMISSIONS TO THE ENVIRONMENT

3.1. Assessment of greenhouse gas emissions to the atmosphere

The following emissions of greenhouse gases (GHG) are considered and determined in the model:

- From burning agricultural residues: CO₂, CO, CH₄, N₂O, and NO_x
- From carpeting and mulching: N₂O
- From standard composting and CaSa-composting: CO₂, N₂O
- From application of urine or biogas slurry: N₂O

We estimated the global warming potential (GWP) for the calculated GHG emissions in compliance with the procedure of the Intergovernmental Panel on Climate Change (IPCC) published by Myhre (2013). For this, we used GWP₁₀₀-factors⁴ (Table S30) and multiplied these with the quantified material flows of emission components which are specifically relevant in terms of climate change.

We determined the total GWP of the farming system analysed for each scenario by summing up all emissions evaluated according to their GWP₁₀₀-factors. The total GWP is expressed in CO₂-equivalents per household and year (kg CO₂e hh⁻¹ yr⁻¹).

⁴ GWP for a time horizon of 100 years (Myhre et al., 2013).

Table S30: The GWP-factors used in this analysis; according to Myhre (2013).

Emission component	GWP ₁₀₀ -factor
CO ₂	1
CO	2
CH ₄	28
N ₂ O	265
NO _x	-11

The unit of the factor is kg CO₂e kg⁻¹.

3.2. Assessment of nutrient emissions to the hydrosphere

The following emissions determined are considered in the assessment of the eutrophication potential (EP):

- From burning agricultural residues: NO_x
- From carpeting and mulching: NH₃
- From standard composting and CaSa-composting: NH₃, P-leaching
- From the application of urine or biogas slurry: NH₃, N-leaching

In addition to the leaching of N and P, gaseous emissions of NO_x and NH₃ are also released into the atmosphere and contribute to nutrient transfers to the hydrosphere. Once in the air, the gases react with sulphuric acid and nitric acid and precipitate in the form of salt, which can easily be relocated to the pedosphere or hydrosphere. In addition, the salts dissolve easily in water, which can lead to an accumulation of nutrients in the water bodies and consequently to excessive growth of plants and algae (i.e. eutrophication).

We estimated the EP in compliance with the procedure of the Institute of Environmental Science at the University of Leiden published by Heijungs et al. (1992) and Guinée (2002). For this, we used the EP-factors (Table S31) and multiplied these with the quantified material flows of emission components, which are specifically relevant in terms of eutrophication. We determined the total EP of a scenario by summing up the single emissions assessed with the respective EP-factors. The total EP of the farming system is expressed in PO₄-equivalents per household per year (kg PO₄e hh⁻¹ yr⁻¹).

Table S31: The EP-factors used in this analysis; according to Heijungs et al. (1992) and Guinée (2002).

Emission component	EP-factor
NO	0.13
NH ₃	0.35
Total P (to water)	3.07
Total N (to water)	0.42

The unit of the factor is kg PO₄e kg⁻¹.

Supplementary 4. SHORT DISCUSSION

Firstly, we want to discuss, that soil and nutrient losses through wind and water erosion are not considered in our model. This is in line drawn by Baijukya et al. (1998), who also neglected soil erosion as a natural output flow when conducting SNB for *shamba* systems in the same local context. However, Lederer et al. (2015) found that erosion dominated nutrient exports from agricultural land in a district of Uganda. On average, N- and P-losses from arable land in Uganda are estimated with, respectively, 5-14 and 1.5-10 kg ha⁻¹ yr⁻¹ (Lederer et al., 2015; Nkonya et al., 2005; Wortmann and Kaizzi, 1998). In addition, Van den Bosch et al. (1998) report a possible range of 0-28 kg N ha⁻¹ yr⁻¹ in East Africa. Hence, erosion control measures like contour planting, catching water in trenches, etc. are absolutely necessary to avoid loss of topsoil. According to local expert judgment, most farmers in the community of MAVUNO are highly aware of soil erosion problems and efforts to implement countermeasures are widely adopted.

Furthermore, we acknowledge that we did not consider possible biochar-related effects when quantifying GHG emissions or nutrient leaching from the composting process. We rather assumed equal processes and emission factors for standard compost and biochar-containing CaSa-compost. We reason that existing scientific data on using biochar

as a soil amendment are contradictory (cf. Mukherjee and Lal, 2014; Van Zwieten et al., 2015). Overall, available data expose: existing uncertainties in various areas, knowledge-gaps on underlying principles and mechanisms, and the admission that possible effects of biochar amendments are highly site-specific (*ibid.*). For these reasons, we judge that it is not yet possible to depict biochar effects in a model such as the one presented here.

Finally, we consider CO₂ emissions from composting or burning residues, and thus sourcing from biogenic material, pursuant to Gómez et al. (2006). We do this simply to obtain information to compare a possible decrease or increase in GHG emissions between the various IPNM strategies.

Supplementary 5. DATA COLLECTION OF MATERIAL AND PROCESS VALUES

In reference to Brunner and Rechberger (2004), data on material characteristics, such as moisture and nutrient content in biomass, crops, or fertilizer substrates, densities, etc., was collected through an extensive literature review, accessing case study documents, and prior research steps. This included information on process parameters including biomass and crop yields, emission factors, compost compositions, etc. (Table S32). Overall, we collected data for determining flows and stocks from various sources, including:

1. Primary data from case study projects, our own experiments, and previous studies, including household surveys, field tests, laboratory analysis, material flow modelling, etc.;
2. Secondary data, including literature reviews, statistics from private and public organizations, etc.; and
3. Estimations / experts judgments.

Table S32: List of material characteristics and other parameter values for the AES-model obtained from data collection and literature review provided with mean values (\bar{x}), standard error (Δx), relative uncertainty (RU), number of values collected to determine the mean value (n), data sources, and additional comments such as to the spatial context of the data.

Name	Unit	\bar{x}	Δx	RU	n	Sources	Comments
Flows and parameters for the NB							
Atmospheric deposition - wet	kg N ha ⁻¹ yr ⁻¹	6.4	± 3.2	50%	5	Calculation, based on Baijukya et al., 1998; Lesschen et al., 2007; Nkonya et al., 2005; Stoorvogel et al., 1993; Wortmann and Kaizzi, 1998	With assumed mean annual precipitation; Burkina Faso, Kagera, Karagwe, Uganda, Tanzania
Atmospheric deposition - wet	kg P ha ⁻¹ yr ⁻¹	0.9	± 0.5	50%	5	Calculation, based on Baijukya et al., 1998; Lesschen et al., 2007; Nkonya et al., 2005; Stoorvogel et al., 1993; Wortmann and Kaizzi, 1998	With assumed mean annual precipitation; Burkina Faso, Kagera, Karagwe, Uganda, Tanzania
Symbiotic BNF with beans	kg N ha ⁻¹ yr ⁻¹	14.0	± 2.3	17%	5	Calculation, based on Baijukya et al., 1998; Lesschen et al., 2007; Nkonya et al., 2005; Stoorvogel et al., 1993; Wortmann and Kaizzi, 1998	Burkina Faso, Kagera, Karagwe, Uganda, Tanzania
A-symbiotic nitrogen fixation	kg N ha ⁻¹ yr ⁻¹	3.3	± 0.3	8%	3	Calculation, based on Baijukya et al., 1998; Lesschen et al., 2007	With assumed mean annual precipitation; Burkina Faso, Kagera, Karagwe, Uganda, Tanzania
Leaching	kg N ha ⁻¹ yr ⁻¹	12.3	± 3.8	31%	4	Calculation, based on Baijukya et al., 1998; Lederer et al., 2015; Nkonya et al., 2005; Wortmann and Kaizzi, 1998	Only loss of N, no loss of P assumed Kagera, Karagwe, Uganda
Gaseous losses	kg N ha ⁻¹ yr ⁻¹	15.7	± 4.3	27%	6	Calculation, based on Baijukya et al., 1998; Krause et al., 2016; Lederer et al., 2015; Lesschen et al., 2007; Nkonya et al., 2005; Wortmann and Kaizzi, 1998	Mean value from literature and own calculation after Eq. (5) in Lesschen et al., 2007; Kagera, Karagwe, Uganda
Mean annual precipitation	mm yr ⁻¹	900	± 150	17%	8	Assumption, based on Baijukya et al., 1998; collected data by Mavuno, accessed through monitoring and evaluation report, 2014	Karagwe
Total N in rainfall	g N ha ⁻¹ mm ⁻¹	4.9	± 2.5	51%	1	Lesschen et al., 2007	sub-Saharan Africa
Total P in rainfall	g P ha ⁻¹ mm ⁻¹	0.6	± 0.5	83%	1	Lesschen et al., 2007	sub-Saharan Africa
Potential evapotranspiration	mm yr ⁻¹	1,239	± 39	3%	2	Calculation, based on Baijukya et al., 1998	Kagera
Crop yields							
Maize, harvest product	t ha ⁻¹ season ⁻¹	33.7	± 3.4	10%	5	Krause et al., 2016	Karagwe on soil amended with CaSa-compost
Maize, harvest product	t ha ⁻¹ season ⁻¹	24.6	± 1.9	8%	5	Krause et al., 2016	Karagwe on soil amended with standard compost
Maize, harvest product	t ha ⁻¹ season ⁻¹	22.3	± 2.3	10%	5	Krause et al., 2016	Karagwe on soil amended with biogas slurry
Maize, harvest product	t ha ⁻¹ season ⁻¹	15.9	± 1.8	11%	5	Krause et al., 2016	Karagwe on un-amended soil
Maize, food product	t ha ⁻¹ season ⁻¹	4.4	± 0.5	12%	5	Krause et al., 2016	Karagwe on soil amended with CaSa-compost
Maize, food product	t ha ⁻¹ season ⁻¹	3.2	± 0.4	12%	5	Krause et al., 2016	Karagwe on soil amended with standard compost
Maize, food product	t ha ⁻¹ season ⁻¹	2.6	± 0.3	13%	5	Krause et al., 2016	Karagwe on soil amended with biogas slurry
Maize, food product	t ha ⁻¹ season ⁻¹	1.1	± 0.1	13%	5	Krause et al., 2016	Karagwe on un-amended soil
Maize, food product	t ha ⁻¹ season ⁻¹	1.2	± 0.03	3%	6	FAOSTAT, 2012; Krause et al., 2016; Smaling et al., 1993; Tanzania, 2012	Average on un-amended soil; Karagwe, Kagera, TZ
Maize, crop residues	t ha ⁻¹ season ⁻¹	11.8	± 1.3	11%	5	Krause et al., 2016	Karagwe on soil amended with CaSa-compost
Maize, crop residues	t ha ⁻¹ season ⁻¹	8.1	± 1.0	12%	5	Krause et al., 2016	Karagwe on soil amended with standard compost
Maize, crop residues	t ha ⁻¹ season ⁻¹	6.6	± 0.8	13%	5	Krause et al., 2016	Karagwe on soil amended with biogas slurry
Maize, crop residues	t ha ⁻¹ season ⁻¹	3.8	± 0.4	11%	5	Krause et al., 2016	Karagwe on un-amended soil
Beans, harvest product	t ha ⁻¹ season ⁻¹	13.8	± 1.6	12%	5	Krause et al., 2016	Karagwe on soil amended with CaSa-compost
Beans, harvest product	t ha ⁻¹ season ⁻¹	5.8	± 0.8	14%	5	Krause et al., 2016	Karagwe on soil amended with standard compost

Beans, harvest product	t ha ⁻¹ season ⁻¹	4.0	± 0.5	14%	5	Krause et al., 2016	Karagwe on soil amended with biogas slurry
Beans, harvest product	t ha ⁻¹ season ⁻¹	2.1	± 0.3	16%	5	Krause et al., 2016	Karagwe on un-amended soil
Beans, food product	t ha ⁻¹ season ⁻¹	4.9	± 0.6	11%	5	Krause et al., 2016	Karagwe on soil amended with CaSa-compost
Beans, food product	t ha ⁻¹ season ⁻¹	1.6	± 0.4	26%	5	Krause et al., 2016	Karagwe on soil amended with standard compost
Beans, food product	t ha ⁻¹ season ⁻¹	0.9	± 0.3	31%	5	Krause et al., 2016	Karagwe on soil amended with biogas slurry
Beans, food product	t ha ⁻¹ season ⁻¹	0.4	± 0.1	27%	5	Krause et al., 2016	Karagwe on un-amended soil
Beans, food product	t ha ⁻¹ season ⁻¹	0.7	± 0.1	14%	7	Bajjukya et al., 1998; FAOSTAT, 2012; Krause et al., 2016; Mavuno, 2014; Smaling et al., 1993; Tanzania, 2012	Average on un-amended soil in Karagwe, Kagera, TZ
Beans, crop residues	t ha ⁻¹ season ⁻¹	5.2	± 0.4	8%	5	Krause et al., 2016	Karagwe on soil amended with CaSa-compost
Beans, crop residues	t ha ⁻¹ season ⁻¹	1.6	± 0.3	19%	5	Krause et al., 2016	Karagwe on soil amended with standard compost
Beans, crop residues	t ha ⁻¹ season ⁻¹	1.2	± 0.2	18%	5	Krause et al., 2016	Karagwe on soil amended with biogas slurry
Beans, crop residues	t ha ⁻¹ season ⁻¹	0.8	± 0.2	27%	5	Krause et al., 2016	Karagwe on un-amended soil
Onion, harvest product	t ha ⁻¹ season ⁻¹	22.4	± 2.8	12%	5	Krause et al., 2016	Karagwe on soil amended with standard compost
Onion, harvest product	t ha ⁻¹ season ⁻¹	11.7	± 2.0	17%	5	Krause et al., 2016	Karagwe on un-amended soil
Onion, food product	t ha ⁻¹ season ⁻¹	14.1	± 1.7	12%	5	Krause et al., 2016	Karagwe on soil amended with standard compost
Onion, food product	t ha ⁻¹ season ⁻¹	5.9	± 1.5	25%	5	Krause et al., 2016	Karagwe on un-amended soil
Onion, food product	t ha ⁻¹ season ⁻¹	3.9	± 1.0	26%	4	FAOSTAT, 2012; Krause et al., 2016; Tanzania, 2012	Average on un-amended soil in Karagwe, Kagera, TZ
Onion, crop residues	t ha ⁻¹ season ⁻¹	1.1	± 0.4	35%	5	Krause et al., 2016	Karagwe on soil amended with standard compost
Onion, crop residues	t ha ⁻¹ season ⁻¹	0.7	± 0.1	16%	5	Krause et al., 2016	Karagwe on un-amended soil
Cabbage, harvest product	t ha ⁻¹ season ⁻¹	78.3	± 6.8	9%	5	Krause et al., 2016	Karagwe on soil amended with CaSa-compost
Cabbage, harvest product	t ha ⁻¹ season ⁻¹	71.4	± 9.8	14%	5	Krause et al., 2016	Karagwe on soil amended with standard compost
Cabbage, harvest product	t ha ⁻¹ season ⁻¹	61.8	± 6.0	10%	5	Krause et al., 2016	Karagwe on soil amended with biogas slurry
Cabbage, food product	t ha ⁻¹ season ⁻¹	50.8	± 5.4	11%	5	Krause et al., 2016	Karagwe on soil amended with CaSa-compost
Cabbage, food product	t ha ⁻¹ season ⁻¹	41.2	± 9.2	22%	5	Krause et al., 2016	Karagwe on soil amended with standard compost
Cabbage, food product	t ha ⁻¹ season ⁻¹	36.0	± 5.3	15%	5	Krause et al., 2016	Karagwe on soil amended with biogas slurry
Cabbage, food product	t ha ⁻¹ season ⁻¹	13.2	± 3.6	27%	3	FAOSTAT, 2012; Krause et al., 2016; Tanzania, 2012	Average on un-amended soil in Karagwe, Kagera, TZ
Cabbage, crop residues	t ha ⁻¹ season ⁻¹	25.8	± 8.0	31%	5	Krause et al., 2016	Karagwe on soil amended with CaSa-compost
Cabbage, crop residues	t ha ⁻¹ season ⁻¹	30.2	± 13.5	45%	5	Krause et al., 2016	Karagwe on soil amended with standard compost
Cabbage, crop residues	t ha ⁻¹ season ⁻¹	25.8	± 8.0	31%	5	Krause et al., 2016	Karagwe on soil amended with biogas slurry

Moisture and nutrient concentrations in crops

Maize, DM in biomass	% (in FM)	0.80	± 0.1	7%	3	KTBL, 2009; Krause et al., 2016	Germany, Karagwe
Maize, N in food product	% (in FM)	0.012	± 0.001	8%	6	Kimetu et al., 2008; KTBL, 2009; Krause et al., 2016; Lederer et al., 2015; Smaling et al., 1993	Germany, East Africa, Karagwe, Kenya, TZ, Uganda
Maize, N in crop residues	% (in FM)	0.005	± 0.0004	9%	3	KTBL, 2009; Krause et al., 2016; Smaling et al., 1993	Germany, Karagwe, East Africa, Kenya, TZ, Uganda
Maize, P in food product	% (in FM)	0.003	± 0.0002	6%	8	FAO, 1992; Kimetu et al., 2008; KTBL, 2009; Krause et al., 2016; Lederer et al., 2015; Smaling et al., 1993; Wadhwa and Bakshi, 2013	Asia, East Africa, generic, Germany, Karagwe, Kenya, TZ, Uganda
Maize, P in crop residues	% (in FM)	0.001	± 0.0005	39%	3	KTBL, 2009; Krause et al., 2016; Smaling et al., 1993	Asia, East Africa, generic, Germany, Karagwe, Kenya, TZ, Uganda
Beans, DM in biomass	% (in FM)	0.86	± 0.0	0%	2	KTBL, 2009; Krause et al., 2016	Germany, Karagwe
Beans, N in food product	% (in FM)	0.020	± 0.01	28%	8	Kimetu et al., 2008; KTBL, 2009; KTBL, 2013; Krause et al., 2016; Krug et al., 2003; Lederer et al., 2015; Smaling, et al., 1993	Germany, East Africa, Karagwe, Kenya, TZ, Uganda
Beans, N in crop residues	% (in FM)	0.011	± 0.002	21%	2	KTBL, 2009; Smaling et al., 1993	Germany, East Africa
Beans, P in food product	% (in FM)	0.003	± 0.001	25%	8	Kimetu et al., 2008; KTBL, 2009; KTBL, 2013; Krause et al., 2016; Krug et al., 2003; Lederer et al., 2015; Smaling, et al., 1993	Germany, East Africa, Karagwe, Kenya, TZ, Uganda
Beans, P in crop residues	% (in FM)	0.0008	± 0.00003	5%	2	KTBL, 2009; Smaling et al., 1993	Germany, East Africa

Onion, DM in biomass	% (in FM)	0.16	± 0.0	0%	1	Krause et al., 2016	Karagwe
Onion, N in food product	% (in FM)	0.003	± 0.002	45%	4	KTBL, 2009; KTBL, 2013; Krug et al., 2003; Lederer et al., 2015	Generic, Germany, Uganda
Onion, N in crop residues	% (in FM)	0.003	± 0.002	45%	4	KTBL, 2009; KTBL, 2013; Krug et al., 2003; Lederer et al., 2015	Assumed to be equivalent to N in food product
Onion, P in food product	% (in FM)	0.0005	± 0.0001	27%	4	KTBL, 2009; KTBL, 2013; Krug et al., 2003; Lederer et al., 2015	Generic, Germany, Uganda
Onion, P in crop residues	% (in FM)	0.0005	± 0.0001	27%	4	KTBL, 2009; KTBL, 2013; Krug et al., 2003; Lederer et al., 2015	Assumed to be equivalent to P in food product
Cabbage, DM in biomass	% (in FM)	0.64	± 0.0	0%	1	KTBL, 2009; KTBL, 2013; Krug et al., 2003; Lederer et al., 2015	Karagwe
Cabbage, N in food product	% (in FM)	0.003	± 0.001	43%	4	KTBL, 2009; KTBL, 2013; Krug et al., 2003; Lederer et al., 2015	Generic, Germany, Uganda
Cabbage, N in crop residues	% (in FM)	0.003	± 0.001	43%	4	KTBL, 2009; KTBL, 2013; Krug et al., 2003; Lederer et al., 2015	Assumed to be equivalent to N in food product
Cabbage, P in food product	% (in FM)	0.0005	± 0.0001	28%	4	KTBL, 2009; KTBL, 2013; Krug et al., 2003; Lederer et al., 2015	Generic, Germany, Uganda
Cabbage, P in crop residues	% (in FM)	0.0005	± 0.0001	28%	4	KTBL, 2009; KTBL, 2013; Krug et al., 2003; Lederer et al., 2015	Assumed to be equivalent to P in food product
Moisture and nutrient concentrations in organic fertilisers							
Water in biogas slurry	g kg ⁻¹ (in FM)	95.6	± 0.5	1%	4	Krause et al., 2016	Karagwe
Water in standard compost	g kg ⁻¹ (in FM)	33.6	± 5.3	16%	4	Krause et al., 2016	Karagwe
Water in CaSa-compost	g kg ⁻¹ (in FM)	32.5	± 1.9	6%	4	Krause et al., 2016	Karagwe
Density biogas slurry	g (DM) dm ⁻³	44.4	± 2.2	5%	4	Krause et al., 2016	Karagwe
Density standard compost	g (DM) dm ⁻³	362.7	± 57.2	16%	4	Krause et al., 2016	Karagwe
Density CaSa-compost	g (DM) dm ⁻³	520.2	± 31.0	6%	4	Krause et al., 2016	Karagwe
Density biogas slurry	g (FM) dm ⁻³	1000.0	± 50.0	5%	4	Krause et al., 2016	Karagwe
Density standard compost	g (FM) dm ⁻³	546.5	± 1.5	0%	4	Krause et al., 2016	Karagwe
Density CaSa-compost	g (FM) dm ⁻³	770.5	± 8.9	1%	4	Krause et al., 2016	Karagwe
Total C in biogas slurry	g kg ⁻¹ (in DM)	347.8	± 6.4	2%	4	Krause et al., 2016	Karagwe
Total C in standard compost	g kg ⁻¹ (in DM)	90.60	± 7.7	8%	4	Krause et al., 2016	Karagwe
Total C in CaSa-compost	g kg ⁻¹ (in DM)	115.6	± 11.4	10%	4	Krause et al., 2016	Karagwe
Total C in biogas slurry	g kg ⁻¹ (in FM)	15.3	± 0.3	2%	4	Krause et al., 2016	Karagwe
Total C in standard compost	g kg ⁻¹ (in FM)	60.16	± 10.8	18%	4	Krause et al., 2016	Karagwe
Total C in CaSa-compost	g kg ⁻¹ (in FM)	78.03	± 8.9	11%	4	Krause et al., 2016	Karagwe
Total N in biogas slurry	g kg ⁻¹ (in DM)	19.8	± 0.1	1%	4	Krause et al., 2016	Karagwe
Total N in standard compost	g kg ⁻¹ (in DM)	5.3	± 0.2	4%	4	Krause et al., 2016	Karagwe
Total N in CaSa-compost	g kg ⁻¹ (in DM)	6.0	± 0.5	8%	4	Krause et al., 2016	Karagwe
Total N in biogas slurry	g kg ⁻¹ (in FM)	0.9	± 0.0	1%	4	Krause et al., 2016	Karagwe
Total N in standard compost	g kg ⁻¹ (in FM)	3.5	± 0.6	16%	4	Krause et al., 2016	Karagwe
Total N in CaSa-compost	g kg ⁻¹ (in FM)	4.0	± 0.4	10%	4	Krause et al., 2016	Karagwe
Total P in biogas slurry	g kg ⁻¹ (in DM)	7.6	± 0.2	3%	4	Krause et al., 2016	Karagwe
Total P in standard compost	g kg ⁻¹ (in DM)	1.2	± 0.1	8%	4	Krause et al., 2016	Karagwe
Total P in CaSa-compost	g kg ⁻¹ (in DM)	3.2	± 0.2	6%	4	Krause et al., 2016	Karagwe
Total P in biogas slurry	g kg ⁻¹ (in FM)	0.3	± 0.0	3%	4	Krause et al., 2016	Karagwe
Total P in standard compost	g kg ⁻¹ (in FM)	0.8	± 0.1	18%	4	Krause et al., 2016	Karagwe
Total P in CaSa-compost	g kg ⁻¹ (in FM)	2.1	± 0.2	9%	4	Krause et al., 2016	Karagwe
Fate of harvest residues							
DM content residues	% FM	0.691	± 0.069	10%	9	Krause et al., 2016	Karagwe

Ash content residues	% DM	0.120	± 0.024	20%	-	Assumption	
Burned	% (of FM)	0.02	± 0.01	48%	4	Mavuno, 2015	Karagwe
Composting	% (of FM)	0.41	± 0.07	16%	4	Mavuno, 2015	Karagwe
Mulching	% (of FM)	0.47	± 0.07	14%	4	Mavuno, 2015	Karagwe
Others	% (of FM)	0.10	± 0.03	27%	4	Mavuno, 2015	Karagwe
Emissions from burning agricultural residues							
CO ₂	g kg ⁻¹ DM burnt	1515	± 177	12%		Aalde et al., 2006	Table 2.5, 'agricultural residues'
CO	g kg ⁻¹ DM burnt	92	± 84	91%		Aalde et al., 2006	Table 2.5, 'agricultural residues'
CH ₄	g kg ⁻¹ DM burnt	2.7	± 0.8	30%		Aalde et al., 2006	Table 2.5, 'agricultural residues'
N ₂ O	g kg ⁻¹ DM burnt	0.1	± 0.02	30%		Aalde et al., 2006	Table 2.5, 'agricultural residues'
Nox	g kg ⁻¹ DM burnt	2.5	± 1.0	40%		Aalde et al., 2006	Table 2.5, 'agricultural residues'
Mulching and grass carpeting							
Grass applied for carpeting	kg (FM) ha ⁻¹ yr ⁻¹	1500	± 450	30%	1	Krause et al., 2016	Karagwe
Total N in grass	% N (in FM)	0.004	± 0.0002	4%	2	Calculation, based on Baijukya et al., 1998	Kagera, Karagwe
Total P in grass	% P (in FM)	0.001	± 0.0002	25%	2	Calculation, based on Baijukya et al., 1998	Kagera, Karagwe
N-recycling of carpeting/mulching	% N	0.87	± 0.03	3%	5	Calculation, based on Larsson et al., 1998; Möller and Stinner, 2009; Schmidt, 1997	Germany, Sweden
P-recycling of carpeting/mulching	% P	1	0			Assumption	Karagwe
Gaseous N losses through denitrification (N ₂ O)	% N	0.016	± 0.003	18%	3	Calculation, based on Larsson et al., 1998; Möller and Stinner, 2009	Germany, Sweden
Gaseous N losses through volatilization (NH ₃)	% N	0.115	± 0.03	26%	2	Calculation, based on Larsson et al., 1998; Schmidt, 1997	Germany, Sweden
Composting: characteristics of the used materials							
Kitchen waste	kg p ⁻¹ d ⁻¹	0.08	± 0.02	30%		Meininger, 2010	Ethiopia
Kitchen waste to compost	% FM	0.8	± 0.08	10%		Lederer et al., 2015	directly to cropland or in compost; Uganda
Total C in kitchen waste	% FM	0.239	± 0.11	44%		Calculation, based on Meininger, 2010	Ethiopia
Total N in kitchen waste	% FM	0.0045	± 0.002	37%		Calculation, based on Meininger, 2010	Ethiopia
Total P in kitchen waste	% FM	0.0010	± 0.0004	36%		Calculation, based on Meininger, 2010	Ethiopia
Total C in local soil (Andosol)	% FM	0.029	± 0.001	2%	5	Krause et al., 2016	Karagwe
Total N in local soil (Andosol)	% FM	0.002	± 0.00005	2%	5	Krause et al., 2016	Karagwe
Total P in local soil (Andosol)	% FM	0.0011	± 0.0003	25%	1	Towett et al., 2015	TZ: Kisongo
Composting: process parameters							
Compost per input	kg kg ⁻¹ (FM)	0.6050	± 0.07	11%	2	Calculation, based on Belevi, 2002; Uenosono et al., 2002	Considering rotting losses ; generic, Japan
N transfer to compost	% N	0.697	± 0.10	14%	3	Calculation, based on Amlinger et al., 2005; Belevi, 2002; Leitzinger, 1999; Sonesson et al., 1997	Generic, Ghana, NA
N transfer into gaseous emissions	% N	0.343	± 0.08	23%	2	Calculation, based on Beck-Friis et al., 2000; Belevi, 2002;	Generic, Sweden
NH ₃ in gaseous N-emissions	% gas. N loss	0.950	± 0.29	30%	1	Beck-Friis, et al., 2000	Sweden
N ₂ O in gaseous N-emissions	% gas. N loss	0.050	± 0.02	30%	1	Beck-Friis et al., 2000	Sweden
P transfer to compost	% P	0.950	± 0.10	10%	3	Assumption, based on Belevi, 2002; Leitzinger, 1999	Generic, Ghana
P transfer to leachate	% P	0.050	± 0.01	10%	3	Assumption, based on Belevi, 2002; Leitzinger, 1999	Generic; average is 0.01 ± 0.01; we assumed increased leaching, because of heavy rain falls in rainy season and un-roofed compost places
C transfer to compost	% C	0.525	± 0.10	20%	2	Calculation, based on Leitzinger, 1999; Uenosono et al., 2002	Ghana, Japan
C transfer gaseous emissions (CO ₂)	% C	0.480	± 0.07	14%	2	Calculation, based on Beck-Friis, et al., 2000; Morand et al., 2005	Sweden

Urine as mineral fertilizer							
N in stored urine from UDDT	g dm ⁻³	5.0	± 1.19	24%	9	Calculation, based on FAO, n.d; Heinonen-Tanski and van Wijk-Sijbesma, 2005; Jönsson and Vinnerås, 2004; Krause and Rotter, 2017; Meinzinger, 2010; Montangero, 2006	Europe, Ethiopia, Tanzania, Uganda, Vietnam
P in stored urine from UDDT	g dm ⁻³	0.5	± 0.23	47%	9	Calculation, based on FAO, n.d; Heinonen-Tanski and van Wijk-Sijbesma, 2005; Jönsson and Vinnerås, 2004; Krause and Rotter, 2017; Meinzinger, 2010; Montangero, 2006	Europe, Ethiopia, Tanzania, Uganda, Vietnam
N-recycling of urine	% N	0.877	± 0.02	3%		Calculation, from NH ₃ emissions, N ₂ O emissions, and N-leaching	
Emissions from fertilizer application							
NH ₃ emissions, urine application	% N	0.073	± 0.017	24%	3	Calculation, based on Jönsson, 2002; Prasertsak et al., 2001; Rodhe et al., 2004	N losses through volatilization; urine assumed as mineral fertilizations; Australia, generic, Sweden
NH ₃ emissions, mulching	% N	0.115	± 0.030	26%	2	Calculation, based on Larsson et al., 1998; Schmidt, 1997	N losses through volatilization; Germany, Sweden
NH ₃ emissions, compost amendment	% N	0.000	± 0.000			Assumption, based on Möller and Stinner, 2009	Neglected because according to literature, NH ₃ -emissions depend on NH ₄ -content, which is hardly found in solid compost; Germany
NH ₃ emissions, biogas slurry amendment	% N	0.139	± 0.022	16%	4	Calculation, based on Amon et al., 2006; Möller and Stinner, 2009	N losses through volatilization; Germany
N ₂ O emissions, mulching	% N	0.016	± 0.003	18%	3	Calculation, based on Larsson et al., 1998; Möller and Stinner, 2009	Germany, Sweden
N ₂ O emissions, application of urine and biogas slurry	% N	0.009	± 0.002	21%	3	Calculation, based on Amon et al., 2006; Möller and Stinner, 2009	Germany
Nitrate leaching	% N	0.041	± 0.015	37%	2	Calculation, based on Prasertsak et al., 2001	Liquid N-losses; Australia
Densities of selected materials in FM							
Ashes	kg dm ⁻³	0.39	± 0.12	31%		Chaggu, 2004	Tanzania
Biochar	kg dm ⁻³	0.27	± 0.10	37%		Lehmann and Joseph, 2009	Generic
Grasses (weeds)	kg dm ⁻³	0.08	± 0.00	1%		Krause et al., 2016	Karagwe
Harvest residues	kg dm ⁻³	0.30	± 0.06	20%		Assumption, based on Krause et al., 2016	Karagwe
Mix of grasses, weeds, harvest residues	kg dm ⁻³	0.24	± 0.03	12%		Calculation, based on Krause et al., 2016	Karagwe
Organic waste	kg dm ⁻³	0.61	± 0.30	49%		Meinzinger, 2010	Generic
Mineral mix	kg dm ⁻³	0.58	± 0.08	14%		Calculation, based on Chaggu, 2004; Krause et al., 2016; Venkataraman et al., 2004	Karagwe, India, Tanzania
Sanitized faeces and dry material	kg dm ⁻³	0.51	± 0.08	17%		Calculation, based on own experiments, March 2015	Karagwe
Sawdust	kg dm ⁻³	0.26	± 0.10	38%		Venkataraman et al., 2004	India
Soil	kg dm ⁻³	1.00	± 0.10	10%		Krause et al., 2016	Karagwe
Urine	kg dm ⁻³	1.00	± 0.05	5%		Assumption, based on UPB, n.d.	Germany
Biogas slurry	kg dm ⁻³	1.0	± 0.05	5%		Krause et al., 2015; based on Vögeli et al., 2014	Karagwe
Standard compost	kg dm ⁻³	0.55	± 0.002	0%		Krause et al., 2015	Karagwe
CaSa-compost	kg dm ⁻³	0.77	± 0.009	1%		Krause et al., 2015	Karagwe

Non-common abbreviations: BNF: biological nitrogen fixation; CaSa: 'Carbonization and Sanitation'; DM: dry matter; Eq.: equation; FM: fresh matter; NA: not available; NB: natural balance; p¹: per person; PB: partial balance; RU: relative uncertainty; UDDT: urine diverting dry toilet; \bar{x} : mean value; Δx : standard error

Table S33: List of plausibility criteria used for evaluation of estimated results from system.

Sub-system	Criteria	Source
AES	SNB	Baijukya, 1998; Lederer et al., 2015; Stoorvogel et al., 1993
AES	BNF	Baijukya, 1998; Lesschen et al., 2007; Nkonya et al., 2005; Stoorvogel et al., 1993; Wortmann and Kaizzi, 1998
AES	Application rates of compost	Buresh, 2007; Finck, 2007; Mafongoya et al., 2007
AES	Application rates of urine	Richert et al., 2010

Non-common abbreviations: AES: agroecosystem; BNF: biological nitrogen fixation; SNB: soil nutrient balancing

Supplementary 6. TERMINOLOGY

In our work, which refers specifically to smallholder farming in Karagwe, TZ, we use some specific words which we briefly introduce in the following paragraph:

<i>Msiri</i>	Swahili for former grassland used for cultivation of annual crops like maize, beans as well as vegetables, which is also a kitchen garden.
<i>Shamba</i>	Swahili for banana-based home gardens that are intercropped with other fruit trees, beans, coffee, egg-plant, etc.
Biogas slurry	Residue that derives from anaerobic digestion of banana tree stumps and cow dung (mixture 2:1 by volume).
CaSa-compost	Product of CaSa-concept to sanitation, which contains pasteurised human faeces, kitchen waste, harvest residues, terracotta particles, ashes, and urine mixed with biochar recovered as residues from microgasifier stoves used for cooking or thermal sanitation.
Standard compost	Compost as commonly prepared by farmers in Karagwe, which contains a mixture of fresh and dried grasses, ash, and kitchen waste.
Solids	Matter collected inside a urine diverting dry toilet (UDDT), which comprise faeces, dry material, some urine which enters the into the compartment for solids' collection due to incomplete urine diversion, and toilet paper.
Urine	Liquid part of human excreta collected in UDDT.
Harvest product	Total above-ground biomass of crops.
Food product	Weight of marketable product of crops, including maize grains, bean seeds, onion bulbs, and cabbage heads after a week's drying in the sun (except for cabbage, which is fresh weight at time of harvesting).

List of References

- Aalde H, Gonzalez P, Gytarsky M, Krug T, Kurz W A, Lasco R D, ..., Raison J (2006) Generic Methodologies Applicable to Multiple Land-Use Categories. Chapter 2 in: 2006 IPCC Guidelines for National Greenhouse Gas Inventories, Intergovernmental Panel on Climate Change (IPCC), National Greenhouse Gas Inventories Programme, 4, 59 pp
- Amlinger F, Peyr S, Cuhls C (2008) Green house gas emissions from composting and mechanical biological treatment. *Waste Manage Res*, 26(1), 47-60
- Amlinger F, Peyr S, Hildebrandt U, Müsken J, Cuhls C, Clemens J (2005) Stand der Technik der Kompostierung. Richtlinie des Bundesministeriums für Land-und Forstwirtschaft, Umwelt und Wasserwirtschaft, 334 pp
- Amon B, Kryvoruchko V, Amon T, Zechmeister-Boltenstern S (2006) Methane, nitrous oxide and ammonia emissions during storage and after application of dairy cattle slurry and influence of slurry treatment. *Agr Ecosyst Environ*, 112(2), 153-162. doi:10.1016/j.agee.2005.08.030
- Baijukya F P, de Steenhuijsen Piters B (1998) Nutrient balances and their consequences in the banana-based land use systems of Bukoba district, northwest Tanzania. *Agr Ecosyst Environ*, 71, 147-158. doi:10.1016/S0167-8809(98)00137-6
- Beck-Friis B, Pell M, Sonesson U, Jönsson H, Kirchmann H (2000) Formation and emission of N₂O and CH₄ from compost heaps of organic household waster. *Environl Monit Assess*, 62(3), 317-331. doi:10.1023/A:1006245227491
- Belevi H (2002) Material flow analysis as a strategic planning tool for regional waste water and solid waste management. In: *Globale Zukunft: Kreislaufwirtschaftskonzepte im kommunalen Abwasser - und Faekalienmanagement*. München, Germany, 13 - 15.05.

- Brunner P H, Rechberger H (2004) Practical handbook of material flow analysis. CRC Press LLC, Boca Raton, Florida, United States, 336 pp
- Buresh R J, Smithson P C, Hellums D T (1997) Building soil phosphorus capital in Africa. In: Replenishing soil fertility in Africa, [Buresh R J, Sanchez P A, Calhoun F (Eds.)], Special Publication 51, Soil Science Society of America and American Society of Agronomy (SSSA), Chicago, United States, 111-149. doi:10.2136/sssaspecpub51.c6
- Chaggu E J (2004) Sustainable environmental protection using modified pit-latrines. PhD thesis, Wageningen University, Netherlands, 141 pp
- De Klein C, Novoa R S, Ogle S, Smith K A, Rochette P, Wirth T C, ..., Williams S A (2006) N₂O emissions from managed soils, and CO₂ emissions from lime and urea application. Chapter 11 in: 2006 IPCC Guidelines for National Greenhouse Gas Inventories, National Greenhouse Gas Inventories Programme, 4, 54 pp
- EfCoiTa (2013) Household survey conducted by EfCoiTa project team. (Documents available on demand, please contact the author.)
- Eghball B, Power J F (1999) Phosphorus-and nitrogen-based manure and compost applications corn production and soil phosphorus. *Soil Sci Soc Am J*, 63(4), 895-901. doi:10.2136/sssaj1999.634895x
- FAO (1992) Gross chemical composition, Physical and chemical changes in maize during processing. Chapter 5 in: Maize in human nutrition, FAO Food and Nutrition Series, No. 25, Food and Agriculture Organization of the United Nations (FAO), Rome, Italy. Available at: <http://www.fao.org/docrep/t0395e/t0395e06.htm> Last access: 12 Feb 15
- FAO (n.d.) Food Balance Sheet, United Republic of Tanzania 2007-2011. FAO, Rome, Italy. Available at: <http://faostat.fao.org/site/368/default.aspx#ancor> Last access: 26 Jan 15
- FAOSTAT (2012) Statistical Databases of the FAO. Final data for 2012, items 'maize', 'beans', 'onion', 'cabbage'; country 'Tanzania'; element 'yield'. Last access: 12 Feb 15
- FAU Physics (n.d.) Anleitung zur Fehlerrechnung. Friedrich Alexander Universität (FAU) Erlangen-Nuremberg, department of Physics. Available at: <http://www.physik.uni-erlangen.de/lehre/daten/NebenfachPraktikum/Anleitung%20zur%20Fehlerrechnung.pdf> Last access: 15 Jun 16
- Finck A (2007) Pflanzenernährung und Düngung in Stichworten (Plant nutrition and fertilization in keywords). 6th edition, Borntraeger, Stuttgart, Germany. ISBN 978-3443031169
- Gómez D R, Watterson J D, Americano B B, Ha C, Marland G, Matsika E, ..., Quadrelli R (2006) Stationary Combustion. Chapter 2 In: 2006 IPCC Guidelines for National Greenhouse Gas Inventories, IPCC
- Guinée J B (2002) Handbook on life cycle assessment: Operational guide to the ISO standards. *Int J Life Cycle Ass*, 7(5), 311-313. doi:10.1007/BF02978897
- Heijungs R, Guinée J B, Huppes G, Lankreijer R M, Udo de Haes H A, ..., De Goede H P (1992) Environmental life cycle assessment of products: guide and backgrounds (part 1). Available at: <https://openaccess.leidenuniv.nl/handle/1887/8061> Last access: 3 Sep 16
- Heinonen-Tanski H, van Wijk-Sijbesma C (2005) Human excreta for plant production. *Bioresource Technol*, 96(4), 403-411. doi:10.1016/j.biortech.2003.10.036
- Jönsson H (2002) Urine separating sewage systems - environmental effects and resource usage. *Water Science and Technology*, 46(6 - 7), 333 - 340
- Jönsson H, Vinnerås B (2004) Adapting the nutrient content of urine and faeces in different countries using FAO and Swedish data. In: Ecosan - Closing the loop, Proceedings of 2nd International Symposium on Ecological Sanitation, Luebeck, Germany, 623-626
- Kimetu J M, Lehmann J, Ngoze S O, Mugendi D N, Kinyangi J M, Riha S, Pell A N (2008) Reversibility of soil productivity decline with organic matter of differing quality along a degradation gradient. *Ecosystems*, 11(5), 726-739. doi:10.1007/s10021-008-9154-z
- Krause A, Kaupenjohann M, George E, Köppel J (2015) Nutrient recycling from sanitation and energy systems to the agroecosystem - Ecological research on case studies in Karagwe, Tanzania. *Afr J Agric Res*, 10(43), 4039-4052. doi:10.5897/AJAR2015.10102
- Krause A, Nehls T, George E, Kaupenjohann M (2016) Organic wastes from bioenergy and ecological sanitation as a soil fertility improver: a field experiment in a tropical Andosol. *SOIL*, 2, 147-162. doi:10.5194/soil-2-147-2016
- Krause A, Rotter V S (2017) Linking energy-sanitation-agriculture: Intersectional resource management in smallholder households in Tanzania. *Sci Total Environ*, 590-591, 514-530. doi:10.1016/j.scitotenv.2017.02.205
- Krug H, Liebig H P, Stützel H (Ed.) (2003) Gemüseproduktion: Ein Lehr- und Nachschlagewerk für Studium und Praxis. [Vegetable production. A textbook and reference work for study and practice] Eugen Ulmer, 1st edition, Stuttgart, Germany. ISBN: 978-3800135844
- KTBL (2009) Faustzahlen für die Landwirtschaft. [Rule-of-thumb figures for agriculture] Kuratorium für Technik und Bauwesen in der Landwirtschaft (KTBL), 14th edition, Darmstadt, Germany. ISBN 978-3939371915
- KTBL (2013) Ökologischer Feldgemüsebau: Betriebswirtschaftliche und produktionstechnische Kalkulationen. KTBL, Darmstadt, Germany, 376 pp. ISBN 978-3941583795

- Landon J R (1991) Booker tropical soil manual: a handbook for soil survey and agricultural land evaluation in the tropics and subtropics. 1st paperback edition, Longman Scientific & Technical Ltd., Essex, England, 474 pp
- Laner D, Rechberger H, Astrup T (2014) Systematic evaluation of uncertainty in material flow analysis. *J Ind Engineering*, 18(6), 859-870. doi:10.1111/jiec.12143
- Larsson L, Ferm M, Kasimir-Klemedtsson Å, Klemedtsson L (1998) Ammonia and nitrous oxide emissions from grass and alfalfa mulches. *Nutr Cycl Agroecosyst*, 51(1), 41-46. doi:10.1023/A:1009799126377
- Lederer J, Karungi J, Ogwang F (2015) The potential of wastes to improve nutrient levels in agricultural soils: A material flow analysis case study from Busia District, Uganda. *Agr Ecosyst Environ*, 207, 26-39. doi:10.1016/j.agee.2015.03.024
- Lehmann J, Joseph S (2009) Biochar for Environmental Management - Science and Technology. Earthscan, London, Sterling, United Kingdom. ISBN 978-1844076581
- Leitzinger C (2000) Ist eine Co-Kompostierung aus stofflicher Sicht in Kumasi/Ghana sinnvoll. Master thesis, SANDEC, Eidgenössische Technische Hochschule (ETH), Zürich, Switzerland.
- Lesschen J P, Stoorvogel J J, Smaling E M, Heuvelink G B, Veldkamp A (2007) A spatially explicit methodology to quantify soil nutrient balances and their uncertainties at the national level. *Nutr Cycl Agroecosys*, 78(2), 111-31. doi:10.1007/s10705-006-9078-y
- Mavuno (2014) Monitoring and evaluation 2014. Report prepared by Mavuno Project, Karagwe, Tanzania. (Documents available on demand, please contact the author.)
- Mavuno (2015) Expert judgment from staff members of Mavuno, including data collection through questionnaires from six participants and through personal communication. (Documents available on demand, please contact the author.)
- Meininger F (2010) Resource Efficiency of urban sanitation systems - A comparative assessment using material and energy flow analysis. Dissertation, Hamburger Berichte zur Siedlungswasserwirtschaft, 75, Technische Universität (TU) Hamburg-Harburg, Germany. doi:10.15480/882.986
- Möller K, Stinner W (2009) Effects of different manuring systems with and without biogas digestion on soil mineral nitrogen content and on gaseous nitrogen losses (ammonia, nitrous oxides). *Eur J Agron*, 30(1), 1-16. doi:10.1016/j.eja.2008.06.003
- Möller K, Stinner W, Deuker A, Leithold G (2008) Effects of different manuring systems with and without biogas digestion on nitrogen cycle and crop yield in mixed organic dairy farming systems. *Nutr Cycl Agroecosys*, 82(3), 209-232. doi:10.1007/s10705-008-9196-9
- Montangero A (2006) Material Flow Analysis for Environmental Sanitation Planning in Developing Countries - An approach to assess material flows with limited data availability. Dissertation 05545, Swiss Federal Institute of Aquatic Science and Technology (Eawag), Leopold-Franzens-University, Innsbruck, Austria
- Morand P, Peres G, Robin P, Yulipriyanto H, Baron S (2005) Gaseous emissions from composting bark/manure mixtures. *Compost Sci Util*, 13(1), 14-26. doi:10.1080/1065657X.2005.10702213
- Mukherjee A, Lal R (2014) The biochar dilemma. *Soil Res*, 52, 217-230. doi:10.1071/SR13359
- Myhre G, Shindell D, Bréon F-M, Collins W, Fuglested J, ..., Zhang H (2013) Anthropogenic and Natural Radiative Forcing - Climate Change 2013: The Physical Science Basis. Contribution of Working Group I to the Fifth Assessment Report of the IPCC [Stocker T F, Qin D, Plattner G-K, Tignor M, ... , Midgley P M (Eds.)], Cambridge University Press, Cambridge, United Kingdom and New York, United States
- Nkonya E, Kaizzi C, Pender J (2005) Determinants of nutrient balances in a maize farming system in eastern Uganda. *Agric Syst*, 85, 155-182. doi:10.1016/j.agsy.2004.04.004
- Prasertsak P, Freney J R, Saffigna P G, Denmead O T, Prove B G (2001) Fate of urea nitrogen applied to a banana crop in the wet tropics of Queensland. *Nutr Cycl Agroecosyst*, 59(1), 65-73. doi:10.1023/A:1009806826141
- Richert A, Gensch R, Jönsson H, Stenström T-A, Dagerskog L (2010) Practical Guidance on the Use of Urine in Crop Production. Stockholm Environment Institute (SEI), EcoSanRes Programme, Stockholm, Sweden, ISBN 978-918-612-521-9
- Rodhe L, Stintzing A R, Steineck S (2004) Ammonia emissions after application of human urine to a clay soil for barley growth. *Nutr Cycl Agroecosys*, 68(2), 191-198. doi:10.1023/B:FRES.0000019046.10885.ee
- Rugalema G H, Okting'Ati A, Johnsen F H (1994) The homegarden agroforestry system of Bukoba district, North-Western Tanzania. 1. Farming system analysis. *Agroforest Syst*, 26(1), 53-64. doi:10.1007/BF00705152
- Schmidt H (1997) Viehlose Fruchtfolge im Ökologischen Landbau - Auswirkungen systemeigener und systemfremder Stickstoffquellen auf Prozesse im Boden und die Entwicklung der Feldfrüchte. [Organic, arable crop rotation - effects of internal and external nitrogen sources on soil processes and the development of crops] Doctoral thesis, Universität Gesamthochschule Kassel, Germany
- Smaling E M A, Stoorvogel J J, Windmeijer P N (1993) Calculating soil nutrient balances in Africa at different scales II. District scale. *Fert Res*, 35(3), 237-250. doi:10.1007/BF00750642
- Smaling E M, Fresco L O, Jager A D (1996) Classifying, monitoring and improving soil nutrient stocks and flows in African agriculture. *Ambio* (Sweden)

- Sombroek W (1966) Amazon Soils. A Reconnaissance of Soils of the Brazilian Amazon Region. Dissertation, Agricultural State University of Wageningen, Centre for Agricultural Publications and Documentation, Netherlands
- Sonesson U, Dalemo M, Mingarini K, Jönsson H (1997) ORWARE—a simulation model for organic waste handling systems. Part 2: Case study and simulation results. *Resour Conserv Recy*, 21(1), 39-54. doi:10.1016/S0921-3449(97)00021-9
- Stoorvogel J J, Smaling E A, Janssen B H (1993) Calculating soil nutrient balances in Africa at different scales I. Supra-national scale. *Fert Res*, 35(3), 227-235. doi:10.1007/BF00750641
- Stoorvogel J J, Smaling E M (1990) Assessment of soil nutrient depletion in Sub-Saharan Africa: 1983-2000. Volume II: Nutrient balances per crop and per Land Use Systems. Winand Staring Centre for Integrated Land, Soil and Water Research, Wageningen, Netherlands
- Tanzania (2012) National Sample Census of Agriculture 2007/2008, Regional Report - Kagera Region, Volume Vh. United Republic of Tanzania, Ministry of Agriculture, Food Security and Cooperatives, ..., The National Bureau of Statistics and the Office of the Chief Government Statistician, Zanzibar, July 12, Tanzania
- Towett E K, Shepherd K D, Tondoh J E, Winowiecki L A, Lulseged T, Nyambura M, ..., Cadisch G (2015) Total elemental composition of soils in Sub-Saharan Africa and relationship with soil forming factors. *Geoderma Regional*, 5, 157-168. doi:10.1016/j.geodrs.2015.06.002
- Uenosono S, Takahashi S, Nagatomoa M, Yamamuro S (2002) Labeling of poultry manure with ¹⁵N. *Soil Sci Plant Nutr*, 48(1), 9-13. doi:10.1080/00380768.2002.10409165
- UPB (n.d.) Density of urine, Umweltprobenbank des Bundes. Available at: <https://www.umweltprobenbank.de/de/documents/profiles/analytes/14980> Last access: 26 Jan 15
- Van den Bosch H, Gitari J N, Ogaro V N, Maobe S, Vlaming J (1998) Monitoring nutrient flows and economic performance in African farming systems (NUTMON): III. Monitoring nutrient flows and balances in three districts in Kenya. *Agr Ecosyst Environ*, 71(1), 63-80. doi:10.1016/S0167-8809(98)00132-7
- Van Zwieten L, Kammann C, Cayuela M, Singh B P, Joseph S, Kimber S, ..., Spokas K (2015) Biochar effects on nitrous oxide and methane emissions from soil. In: *Biochar for Environmental Management*, [Lehmann J, Joseph S (Eds.)], Routledge, London, United Kingdom, 487-518
- Venkataraman C, Joshi P, Sethi V, Kohli S, Ravi M R (2004) Aerosol and carbon monoxide emissions from low-temperature combustion in a sawdust packed-bed stove. *Aerosol Sci Tech*, 38(1), 50-61. doi:10.1080/02786820490247614
- Vögeli Y, Lohri C R, Gallardo A, Diener S, Zurbrugg C (2014) *Anaerobic Digestion of Biowaste in Developing Countries. Practical Information and Case Studies*. Easwag, Dübendorf, Switzerland. ISBN 978-3-906484-58-7
- Wadhwa M, Bakshi M P S (2013) Utilization of fruit and vegetable wastes as livestock feed and as substrates for generation of other value-added products. *FAO Regional Office for Asia and the Pacific*, Bangkok, Thailand. Available at: <http://www.fao.org/docrep/018/i3273e/i3273e.pdf> Last access: 12 Feb 15
- Wortmann C S, Kaizzi C K (1998) Nutrient balances and expected effects of alternative practices in farming systems of Uganda. *Agric Ecosyst Environ*, 71, 115-129. doi:10.1016/S0167-8809(98)00135-2

List of Abbreviations

AirIn	Input of air
AirOut	Output of air
Ash & char	Residues available after cooking with a microgasifier, i.e. a mix of ash and char particles
A	Ash
AES	Agroecosystem
AM	Abbreviation agroecosystem of a msiri
BiogaST	Project ‘Biogas Support for Tanzania’
BNF	Biological nitrogen fixation
C	Carbon
c	Concentration
CaSa	Project ‘Carbonization and Sanitation’
CHEMA	Programme for Community Habitat Environmental Management, a local NGO and project partner of the present research project
DM	Dry matter
E	Export flow
EF	Emission factor
EfCoiTa	Project ‘Efficient Cooking in Tanzania’
EP	Eutrophication potential
FM	Fresh matter
FP	Food Product
G	Good
GHG	Greenhouse gas
GWP	Global warming potential
HH	Households
HR	Harvest residue
I	Import flow
IN	Input flows
IPCC	Intergovernmental Panel on Climate Change
IPNM	Integrated plant nutrient management
KW	Kitchen waste
LU	Land use
\dot{m}	Annual material flows
MAVUNO	Swahili for ‘harvest’, name of a local NGO and project partner of the present research project
MES	Micro energy system
MF	Model factor
MFA	Material flow analysis
MSS	Micro sanitation system
n	Total sample size, i.e. number of replications
N	Nitrogen
NA	Not analysed
NB	Natural balance
NGO	Non-governmental organisation
OUT	Output flows
P	Phosphorus
PB	Partial balance
σ	Standard deviation
SNB	Soil nutrient balances
STAN	SubSTance flow Analysis (software)
TC	Transfer coefficients
TZ	Tanzania
UDDT	Urine diverting dry toilet

Words in Swahili:

<i>Shamba</i>	Fields used for intercropping of perennial and annual crops, located directly surrounding smallholders houses and also referred to as ‘banana-based home gardens’.
<i>Msiri</i>	Fields used for intercropping system of annual crops; surrounding <i>shamba</i> .