

5G UFMC Scheme Performance with Different Numerologies

Lambros Sakkas, Eleftherios Stergiou, Georgios Tsoumanis *  and Constantinos T. Angelis

Department of Informatics and Telecommunications, Campus of Arta, University of Ioannina, 47150 Arta, Greece; s.sakkas@uoi.gr (L.S.); ster@uoi.gr (E.S.); kangelis@uoi.gr (C.T.A.)

* Correspondence: gtsoum@uoi.gr

Abstract: 5G is the latest mobile communications standard that is spreading fast across the world. Recently defined requirements for 5G systems have led to higher applications' requirements regarding data rates, lower requirements for latency, and higher efficiency regarding the spectrum usage. Universal Filtered Multi-Carrier (UFMC) is one new candidate modulation scheme for emergent Fifth Generation (5G) communication systems. This paper focuses on Universal Filtered Multi-Carrier (UFMC) design aspects in terms of Bit Error Rate (BER) performance in relation to the filter length used in subband filtering. Simulation results show that BER and CCDF performance varies for different filter lengths and modulation schemes. The main achievement of this work is that the results show that different Dolph–Chebyshev FIR filter lengths do not affect the BER performance both for the 64 and 256 QAM.

Keywords: 5G; UFMC; OFDM; spectral efficiency; cyclic prefix



Citation: Sakkas, L.; Stergiou, E.; Tsoumanis, G.; Angelis, C.T. 5G UFMC Scheme Performance with Different Numerologies. *Electronics* **2021**, *10*, 1915. <https://doi.org/10.3390/electronics10161915>

Academic Editors: Ana Vázquez Alejos and Christos J. Bouras

Received: 30 June 2021

Accepted: 6 August 2021

Published: 10 August 2021

Publisher's Note: MDPI stays neutral with regard to jurisdictional claims in published maps and institutional affiliations.



Copyright: © 2021 by the authors. Licensee MDPI, Basel, Switzerland. This article is an open access article distributed under the terms and conditions of the Creative Commons Attribution (CC BY) license (<https://creativecommons.org/licenses/by/4.0/>).

1. Introduction

The 4G communication systems, mainly LTE and Wi-Fi, widely adopted OFDM as the dominant multicarrier modulation technique. The main reason is that OFDM is robust against channel delays [1], while single-tap frequency domain equalization [2] and efficient implementation [3] also play essential roles in efficient OFDM-based system implementations.

Besides these, OFDM presents some major disadvantages that are not often highlighted. These are, mainly, the strict synchronization requirements [4] and the loss in spectral efficiency due to higher sidelobes and Cyclic Prefix insertion [5], the loss of orthogonality due to imperfect synchronization, the amplifier inefficiency due to large peak to average power ratio (PAR), the high out-of-band power, and the need for subcarrier intermodulation reduction. Another major drawback is the intercarrier interference (ICI) that is present in orthogonal frequency division multiplexing (OFDM) systems.

Taking the above into account, new modulation techniques are being considered for 5G communication systems to tackle some of these factors. Universal Filtered Multi-Carrier (UFMC) transmission scheme is one new candidate modulation scheme for emergent Fifth Generation (5G) communication systems [6]. The use of UFMC overcomes the problem of intercarrier interference (ICI) in orthogonal frequency division multiplexing (OFDM) systems [7].

Moreover, UFMC has been proofed to be the best choice for the transmission of very small bursts (e.g., for machine to machine communications) and under very tight response time requirements (e.g., for car-to-car communications) [8].

UFMC modulation scheme uses FIR Dolph–Chebyshev (DC) filter in each subband. Many researchers [8,9] have proposed design modifications and improvements in order to maximize the UFMC performance. However, this generally leads to increased computational complexity. When UFMC has to be used in a constrained computational environment, time constraints should be taken into account. This becomes more important

when UFMC-based transceivers are implemented using multicore DSP Processors, heterogeneous multiprocessor SoC, or general purpose multi-core processors. Thus, a more generalized study should be performed.

In this study, the transceiver architecture (i.e., M-QAM, FFT-size) and filter design (i.e., length and side lobe attenuation) were studied in the UFMC system, without the constraints of short burst communication environment and without modified FIR filter designs that add computational complexity. Since the increase of the filter’s side lobe attenuation affects the system performance in terms of reducing the OOB [10], we focused on the length of the filter since this parameter affects the computational complexity of the overall system.

The focus of this paper is mainly on studying UFMC with large FFT and M-QAM values that could lead to better UFMC performance in parallel processing environments. In these cases, the lack of added computational complexity from the larger FFT and M-QAM values will be suppressed from the multiprocessing techniques and the overall performance will be improved.

The paper is structured as follows. In Section 2, a brief introduction of the structures of OFDM and UFMC schemes is presented. In Section 3, the performance of computational complexity, power spectral density, BER, and CCDF are simulated and compared using various parameters of the UFMC multicarrier scheme. Finally, the conclusions are drawn in Section 4.

2. Universal Filtered Multi-Carrier (UFMC)

Applications that use the 5G systems with the latest requirements that ITU has defined, require, among other aspects, higher data rates, lower latency, and more efficient spectrum usage. The most commonly used modulations that meet these criteria are the filter-bank based multicarrier (FBMC) and the Universal Filtered Multi-Carrier (UFMC) technique. This paper focuses on the new modulation technique known as Universal Filtered Multi-Carrier (UFMC) and compares it with OFDM within a generic framework.

Figure 1 shows the basic UFMC block diagram that was used in this study. In our study, we followed the idea of FFT demodulation in receiver that was presented in [6,11]. Using FFT for the demodulation is an ideal candidate for improvement of the UFMC performance in parallel processing environments.

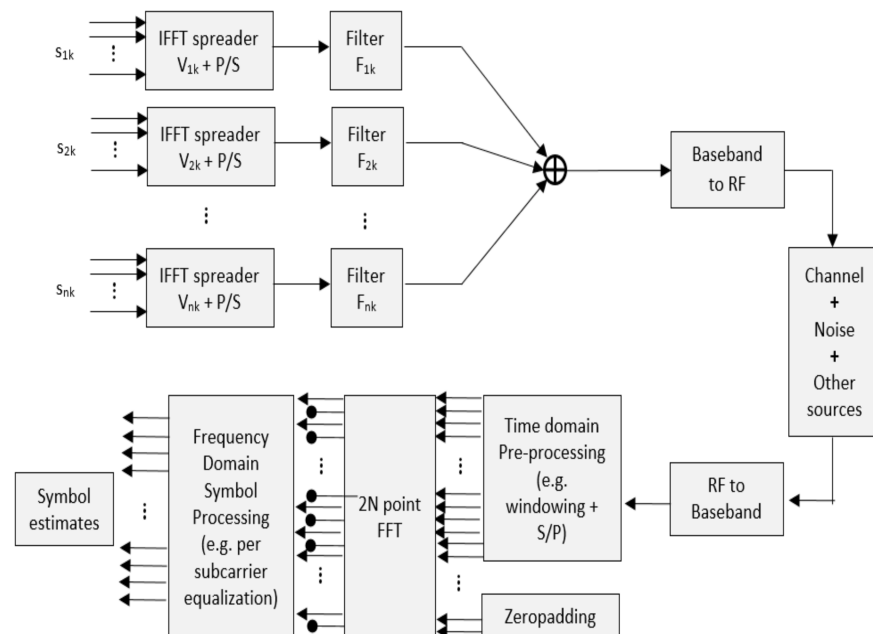

Figure 1. UFMC transceiver block diagram.

UFMC is seen as a generalization of the Filtered OFDM modulation. In UFMC, the entire band is filtered in filtered OFDM and individual subcarriers are filtered in FBMC, while groups of subcarriers (subbands) are filtered in UFMC, as seen in Figure 2.

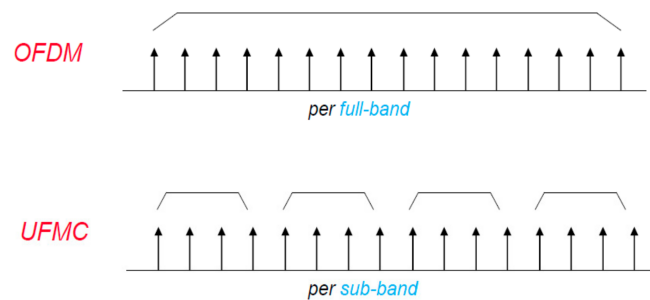
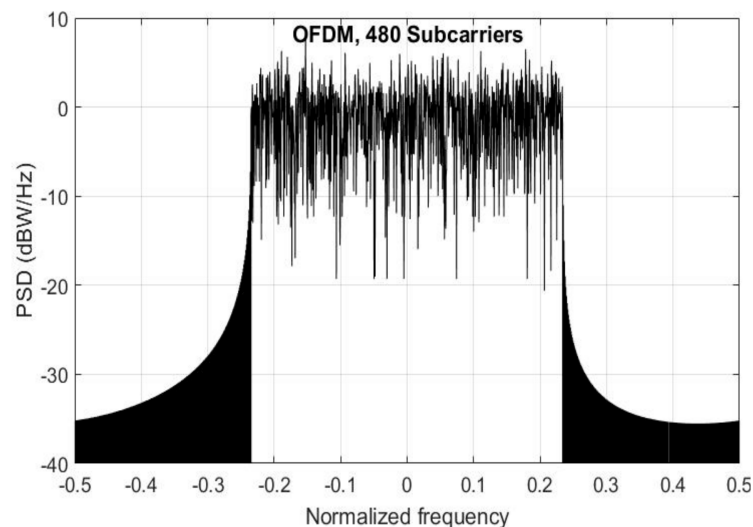

Figure 2. OFDM and UFMC different type of waveforms and filter operation.

This subcarrier grouping allows for reducing the filter length (when compared with FBMC). In addition, UFMC can still use QAM, which works with existing MIMO schemes. The basic idea is to use 64 or 256 QAM in order to increase the overall system capacity.

Regarding the full band of subcarriers (N), it is divided into subbands, each subband holding a fixed number of subcarriers, as seen in Figure 3. Note that not all subbands need to be employed for a given transmission. An N -point IFFT is computed for each subband, while zeros are inserted in the cases of unallocated carriers. Then, each subband is filtered by a filter of length L , and the responses from the different subbands are summed. The filtering is essential in order to reduce the out-of-band spectral emissions. Different filters per subband can be designed. For example, many researchers [12] use windowed-sinc filters with Blackman windowing Functions, while other researchers [13] use Zero Padding Length Design filter techniques.

In this study, the same filter was used for each subband. A Chebyshev window with parameterized sidelobe attenuation was employed to filter the IFFT output per subband [8,9].



(a)

Figure 3. Cont.

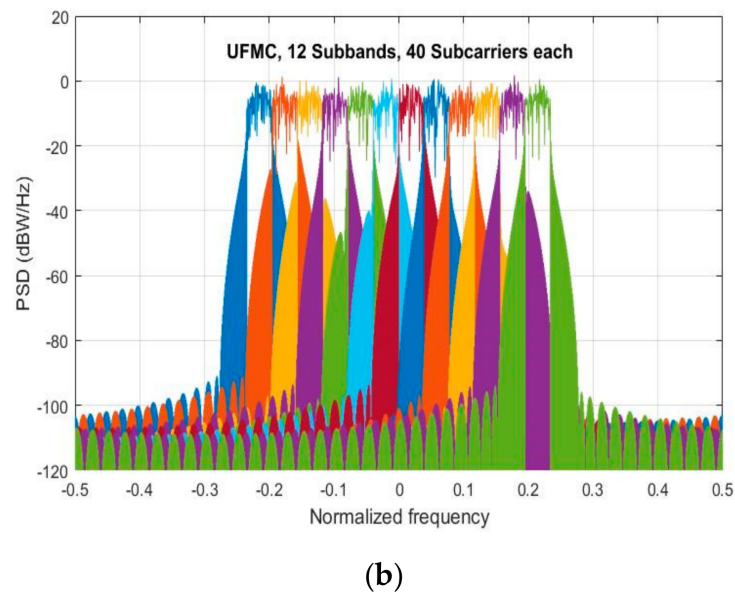

Figure 3. Power Spectral Density (PSD) plots versus normalized frequency for (a) OFDM and (b) UFMC modulation schemes.

3. Numerical Results and Discussion

In this section, we carry several simulations for different FFT sizes and M-QAM values. In all cases, the Dolph–Chebyshev filter has a 60-dB side-lobe attenuation.

Simulation results clearly show that the BER performance of the UFMC modulation scheme is increased when the FFT size increases, as it is seen from the comparison of Figures 4–7. BER values are comparable to the ones found in the literature [12].

The most important result is that, in the case of 2048 FFT, different Dolph–Chebyshev FIR filter lengths do not affect the BER performance both for the 64 and 256 QAM. These results open the way for using UFMC, mainly the 256 QAM, without taking into consideration the filter length that could insert computational complexity in the UFMC transceiver.

Power Complementary Cumulative Distribution Function (CCDF) curves provide critical information about the signals encountered in 5G systems. These curves also provide the peak-to-average power data needed by component designers. Within this regulation, we performed CCDF calculations for different combinations of modulations, used FFTs, and Filter Lengths [14].

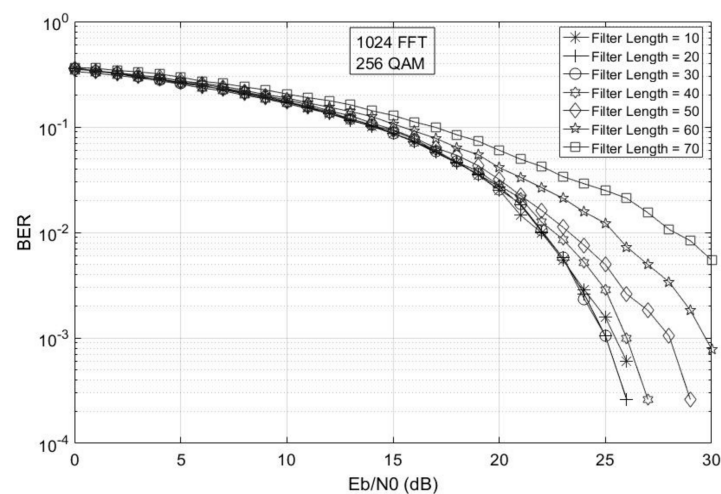

Figure 4. UFMC BER versus (E_b/N_0) dB for various Filter Lengths in the case of 1024 FFT and 256 QAM.

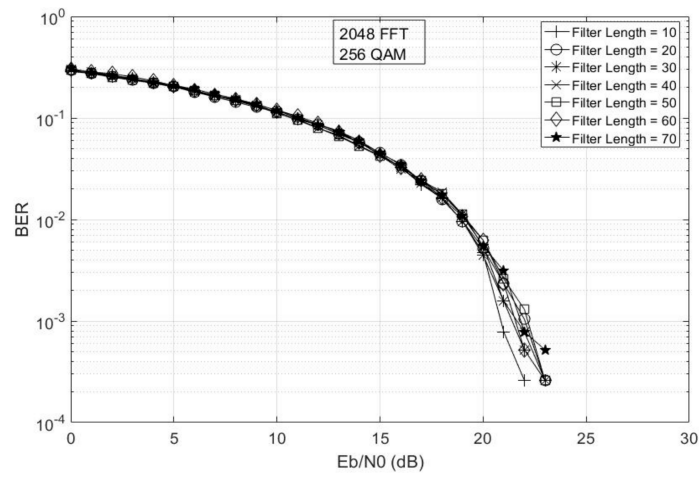

Figure 5. UPMC BER versus (E_b/N_0) dB for various Filter Lengths in the case of 2048 FFT and 256 QAM.

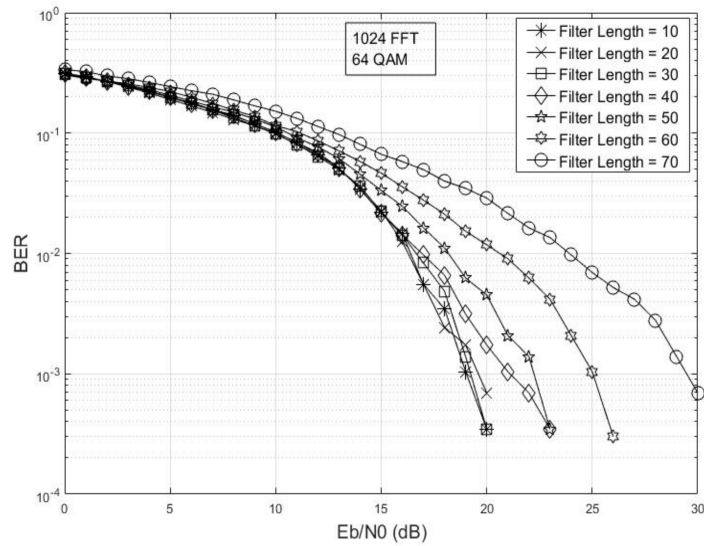

Figure 6. UPMC BER versus (E_b/N_0) dB for various Filter Lengths in the case of 1024 FFT and 64 QAM.

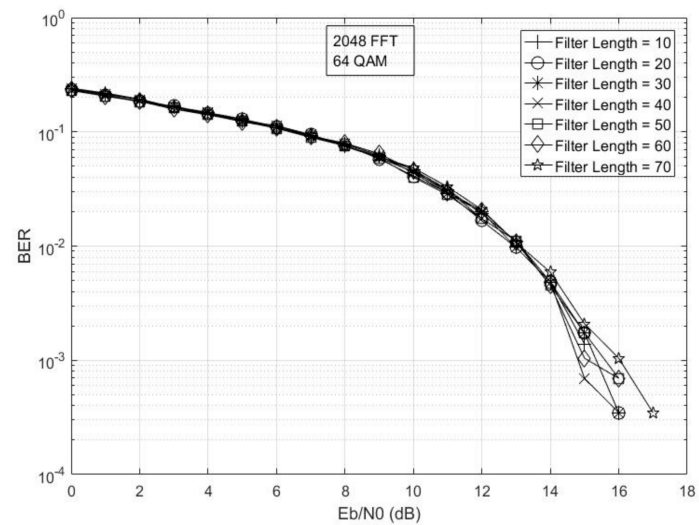

Figure 7. UPMC BER versus (E_b/N_0) dB for various Filter Lengths in the case of 2048 FFT and 64 QAM.

In Figures 8–11, we have shown the CCDF of the PAPR curves for 64QAM, and 256-QAM, respectively, and 1024 and 2048 FFT for different filter lengths. In all cases, filter length impacts the system performance in different ways. Thus, it is critical to calculate the CCDF values for a filter length that is comparable to the channel length (or CP length in CP-OFDM systems). This argument was also proposed in the SoTA UFMC system [7,15–17].

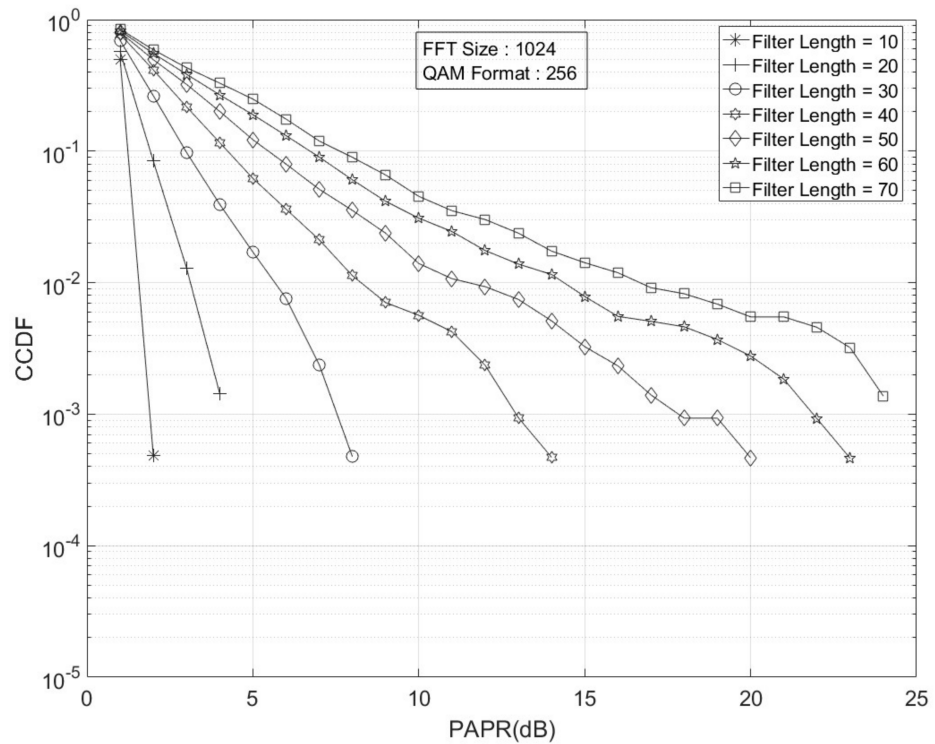

Figure 8. UFMC CCDF versus PAPR (dB) for various Filter Lengths in the case of 1024 FFT and 256 QAM.

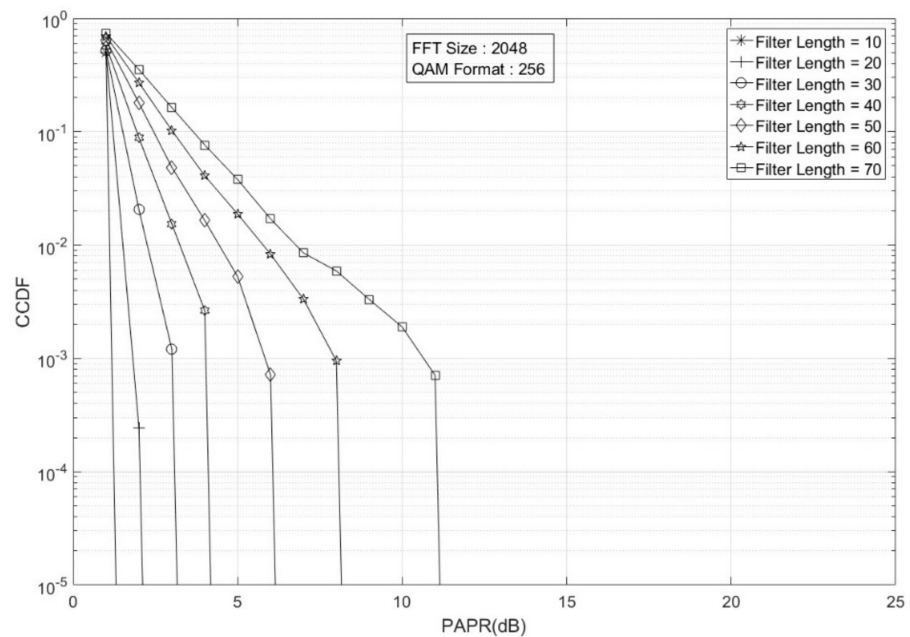

Figure 9. UFMC CCDF versus PAPR (dB) for various Filter Lengths in the case of 2048 FFT and 256 QAM.

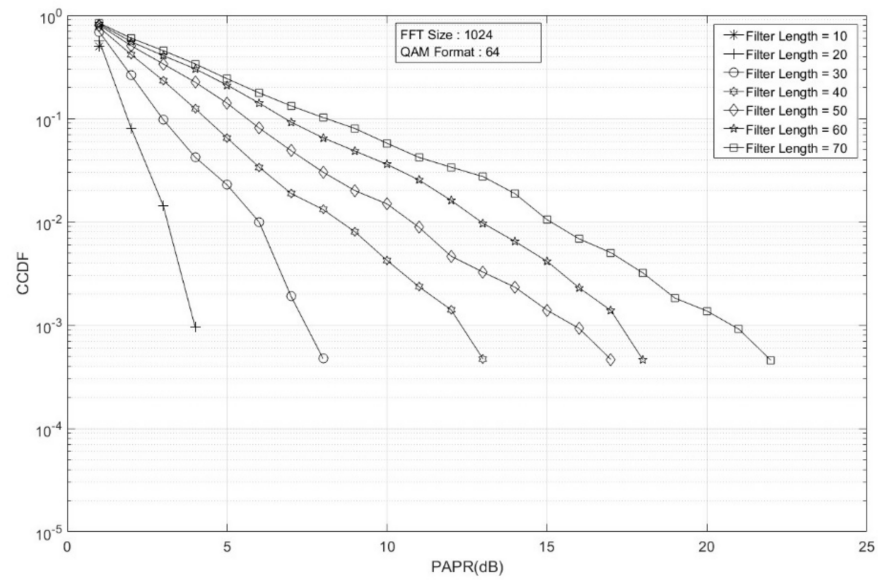

Figure 10. UFCM CCDF versus PAPR (dB) for various Filter Lengths in the case of 1024 FFT and 64 QAM.

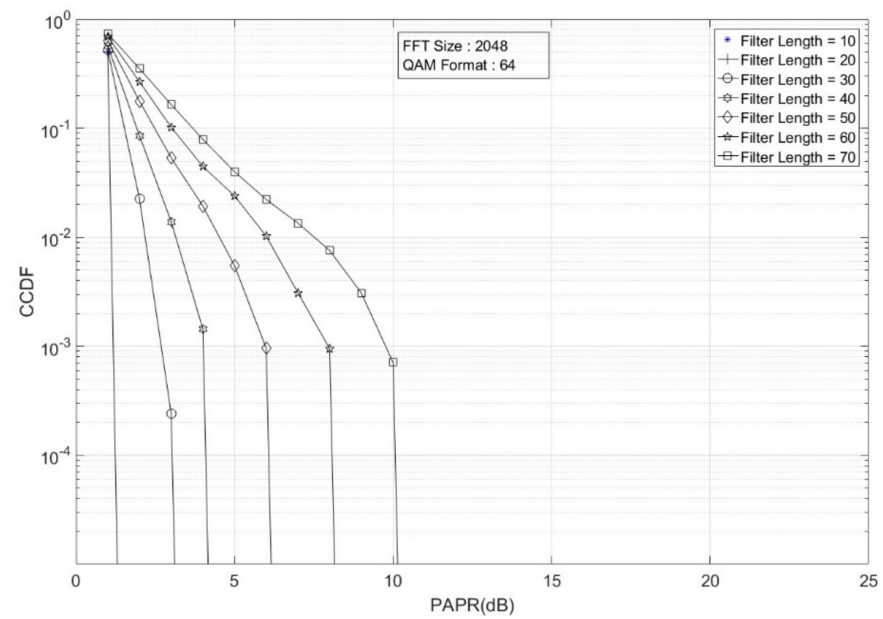

Figure 11. UFCM CCDF versus PAPR (dB) for various Filter Lengths in the case of 2048 FFT and 64 QAM.

Figure 12 shows UFCM CCDF versus PAPR (dB) for Filter Length equal to 40 and different FFT lengths and QAM. As it is seen, different FFT lengths affect the system performance in terms of CCDF values.

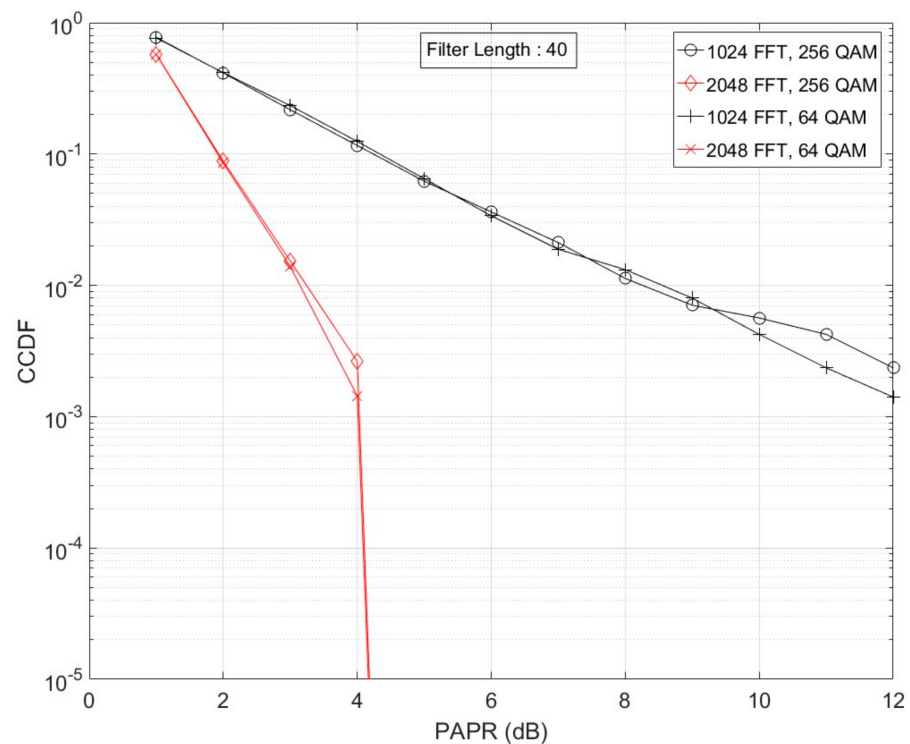

Figure 12. UFCM CCDF versus PAPR (dB) for Filter Length equal to 40 and different FFT and QAM.

4. Conclusions

The aim of this paper was to study UFCM with large FFT and M-QAM values that could lead to better UFCM performance in parallel processing environments. In these cases, the lack of added computational complexity from the larger FFT and M-QAM values will be suppressed from the multiprocessing techniques and the overall performance will be improved.

Simulation results have clearly shown that when the FFT size increases, the BER performance becomes better and the most important is not affected by the variations of the Dolph–Chebyshev FIR filter lengths.

Further exploration should include system level investigations including a MIMO channel with different delay spreads and MIMO antennas and their impact for the unified frame structure, as being considered for 5G systems.

Author Contributions: Conceptualization, L.S. and C.T.A.; methodology, L.S.; validation, C.T.A., E.S., and G.T.; investigation, L.S.; resources, C.T.A.; data curation, E.S.; writing—original draft preparation, L.S.; writing—review and editing, C.T.A. and G.T.; visualization, E.S.; supervision, C.T.A. All authors have read and agreed to the published version of the manuscript.

Funding: This research received no external funding.

Conflicts of Interest: The authors declare no conflict of interest.

References

1. Gorokhov, A.; Linnartz, J. Robust OFDM Receivers for Dispersive Time-Varying Channels: Equalization and Channel Acquisition. *IEEE Trans. Commun.* **2004**, *52*, 572. [[CrossRef](#)]
2. Tao, Y.; Liu, L.; Liu, S.; Zhang, Z. A survey: Several technologies of non-orthogonal transmission for 5G. *China Commun.* **2015**, *12*, 1–15. [[CrossRef](#)]
3. Simsek, M.; Aijaz, A.; Dohler, M.; Sachs, J.; Fettweis, G. 5G-enabled tactile Internet. *IEEE J. Sel. Areas Commun.* **2016**, *34*, 460–473. [[CrossRef](#)]
4. Akyildiz, I.F.; Nie, S.; Lin, S.-C.; Chandrasekaran, M. 5G roadmap: 10 key enabling technologies. *Comput. Netw.* **2016**, *106*, 17–48. [[CrossRef](#)]

5. Wunder, G.; Jung, P.; Kasparick, M.; Wild, T.; Schaich, F.; Chen, Y.; Ten Brink, S.; Gaspar, I.; Michailow, N.; Festag, A.; et al. 5G NOW: Non-orthogonal, asynchronous waveforms for future mobile applications. *IEEE Commun. Mag.* **2014**, *52*, 97–105. [[CrossRef](#)]
6. Kasparick, M.; Wunder, G.; Schaich, C.F.; Wild, T.; Berg, V.; Cassiau, N.; Dor, J.; Ktnas, D.; Dryjaski, M.; Pietrzyk, S.; et al. 5G waveform candidate selection. *Eur. Res. Project Tech. Rep.* **2013**. Available online: <https://www.is-wireless.com/wp-content/uploads/2015/07/5GNOW-Deliverables-5G-Waveform-Candidate-Selection.pdf> (accessed on 30 June 2021).
7. Vakilian, V.; Wild, T.; Schaich, F.; Brink, S.; Frigon, J. Universal-Filtered Multi-Carrier Technique for Wireless Systems Beyond LTE. In Proceedings of the 2013 IEEE Globecom Workshops (GC Wkshps), Atlanta, GA, USA, 9–13 December 2013; pp. 223–228.
8. Schaich, F.; Wild, T.; Chen, Y. Waveform Contenders for 5G-Suitability for Short Packet and Low Latency Transmission. In Proceedings of the 2014 IEEE 79th Vehicular Technology Conference (VTC Spring), Seoul, Korea, 18–21 May 2014; pp. 1–5.
9. Wild, T.; Schaich, F.; Chen, Y. 5G air interface design based on Universal Filtered (UF-)OFDM. In Proceedings of the 2014 19th International Conference on Digital Signal Processing, Hong Kong, China, 20–23 August 2014; pp. 699–704.
10. Yongxue, W.; Sunan, W.; Weiqiang, W. Performance analysis of the universal filtered multi-carrier (UFMC) waveform for 5G system. In *Journal of Physics: Conference Series*; IOP Publishing: Bristol, UK, 2019; Volume 1169.
11. Wen, J.; Hua, J.; Lu, W.; Zhang, Y.; Wang, D. Design of Waveform Shaping Filter in the UFMC System. *IEEE Access* **2018**, *6*, 32300–32309. [[CrossRef](#)]
12. Di Stasio, F.; Mondin, M.; Daneshgaran, F. Multirate 5G Downlink Performance Comparison for f-OFDM and w-OFDM Schemes with Different Numerologies. In Proceedings of the 2018 International Symposium on Networks, Computers and Communications (ISNCC), Rome, Italy, 19–21 June 2018.
13. Zhang, L.; Ijaz, A.; Xiao, P.; Imran, M.A.; Tafazolli, R. MU-UFMC system performance analysis and optimal filter length and zero padding length design. *arXiv* **2016**, arXiv:1603.09169.
14. Characterizing Digitally Modulated Signals with CCDF Curves, Application Note, Agilent. Technologies Literature No.5968-6875E. 2000. Available online: <https://www.keysight.com/cn/zh/assets/7018-06723/application-notes/5968-6875.pdf> (accessed on 30 June 2021).
15. 5G NOW. D3.2: 5G Waveform Candidate Selection. Available online: https://is-wireless.com/wp-content/uploads/2015/07/5GNOW_Deliverables-5G-Waveform-Candidate-Selection-part-2.pdf (accessed on 30 June 2021).
16. Chen, Y.; Schaich, F.; Wild, T. Multiple access and waveforms for 5G: IDMA and universal filtered multicarrier. In Proceedings of the 2014 IEEE 79th Vehicular Technology Conference (VTC Spring), Seoul, Korea, 18–21 May 2014; pp. 1–5.
17. Schaich, F.; Wild, T. Relaxed synchronization support of universal filtered multicarrier including autonomous timing advance. In Proceedings of the 2014 11th International Symposium on Wireless Communications Systems (ISWCS), Barcelona, Spain, 26–29 August 2014; pp. 203–208.