

## Article

# An Assessment of Receiver Algorithms for Distributed Massive MIMO Systems: Investigating Design Solutions and Performance

Ali Gashtasbi <sup>1</sup>, Mário Marques da Silva <sup>2,3,4,5,\*</sup>  and Rui Dinis <sup>1,3,4</sup> 

<sup>1</sup> Faculty of Sciences and Technology, Universidade Nova, 2829-516 Caparica, Portugal; a.gashtasbi@campus.fct.unl.pt (A.G.); rdinis@fct.unl.pt (R.D.)

<sup>2</sup> Department of Sciences and Technologies, Universidade Autónoma de Lisboa, 1169-023 Lisboa, Portugal

<sup>3</sup> Autonomia TechLab, 1169-023 Lisboa, Portugal

<sup>4</sup> Instituto de Telecomunicações, 1049-001 Lisboa, Portugal

<sup>5</sup> Ci2—Centro de Investigação em Cidades Inteligentes, 2300-313 Tomar, Portugal

\* Correspondence: marques.silva@ieee.org

**Abstract:** This study investigates receiver design solutions for distributed Massive Multiple Input Multiple Output (D-m MIMO) systems, taking into account parameters such as number of access points as well as concerns related to channel estimates that use single-carrier frequency-domain equalization (SC-FDE). A significant contribution of this research is the integration of Low-Density Parity-Check (LDPC) codes to simplify coding complexity and enhance communication efficiency. The research examines different receiver designs, such as spatial antenna correlation and sophisticated channel estimation methods. The authors propose integrating LDPC codes into the receiver architecture to simplify computations and enhance error correction and decoding. Moreover, the paper examines performance evaluation measures and approaches, highlighting the trade-offs among complexity, spectral efficiency, and error performance. The comparative analysis indicates the benefits, in terms of performance, of incorporating LDPC codes and improving system throughput and dependability. We examine four distinct receiver algorithms: zero-forcing (ZF), minimum mean square error (MMSE), maximum ratio combining (MRC), and equal gain combining (EGC). The study shows that MRC and EGC receivers work well in D-m MIMO because they make the receiver system less computationally demanding.

**Keywords:** D-m MIMO; LDPC; receiver; SC-FDE



**Citation:** Gashtasbi, A.; Marques da Silva, M.; Dinis, R. An Assessment of Receiver Algorithms for Distributed Massive MIMO Systems: Investigating Design Solutions and Performance. *Electronics* **2024**, *13*, 1560. <https://doi.org/10.3390/electronics13081560>

Academic Editors: Sye Loong Keoh and Minghui Li

Received: 22 March 2024

Revised: 15 April 2024

Accepted: 17 April 2024

Published: 19 April 2024



**Copyright:** © 2024 by the authors. Licensee MDPI, Basel, Switzerland. This article is an open access article distributed under the terms and conditions of the Creative Commons Attribution (CC BY) license (<https://creativecommons.org/licenses/by/4.0/>).

## 1. Introduction

### 1.1. Motivation

The architecture of fifth-generation Cellular Communications (5G) has been developed and implemented [1]. Upgrading the existing network to sixth-generation Cellular Communications (6G) is necessary due to the increasing customer demand for the Internet of Things (IoT) [2]. The services will provide a superior quality of service (QoS) to users, cost-effective implementation for operators, higher capacity, higher data rates, greater bandwidth, and reduced interference. Multiple Input Multiple Output (MIMO) has led to the development of many approaches to address the difficulties related to signal coverage and capacity/bit rate [3]. Hence, network designers are looking for innovative MIMO strategies to adopt [4].

Distributed massive MIMO (D-m MIMO) is a modern version of classic MIMO wireless transmission technology. It serves as a crucial and foundational component in the advancement of wireless transmission and network technology for mobile communications. D-m MIMO, in contrast to standard MIMO, can progress into a more intricate wireless network configuration. D-m MIMO, in modern networks, emerges with the integration

of multiple concepts such as intelligent reflecting surfaces (IRS), large intelligent surfaces (LIS), and radio stripes (RS) in wireless networks [5].

Academics and corporations are interested in IRS as a potential early-stage technology [6]. To limit or use the flexible multipath publication environment for better quality, wireless cellular communications networks typically use transceiver end-point transmission techniques, but they have not been able to manage the environment itself.

A programmable and controllable intelligent radio environment can be built using an IRS. The huge and extremely thin metasurface structure is constructed of metal or dielectric material. Numerous passive sub-wavelength dispersion components are present in this metasurface and have a distinct physical structure. Software may control the components to change the radio frequency (RF) signals' reflected electromagnetic (EM) properties, such as phase shift [2,7]. The reflected radiation pattern of incoming RF signals can be dynamically changed in real-time with the help of unified phase control of all the scattering components, adding new degrees of freedom and enhancing wireless network performance [8].

Massive active antenna arrays that are akin to the massive MIMO (m-MIMO) concept but significantly larger are referred to as LIS [9]. A LIS produces, sends, and receives signals as a result. They can virtually endlessly control electromagnetic waves on the surface thanks to this property. The LIS idea can be thought of as a more expansive variation of conventional enormous MIMO systems. Intelligent surfaces are real-world objects that have the potential to transmit and receive electromagnetic waves because they are electromagnetically enabled in theory. Energy may be concentrated in three-dimensional space and delivered and received thanks to the highly accurate control of these fields [10]. These surfaces will therefore open completely new avenues for communication as well as for monitoring and managing the electromagnetic environment. The natural progression of the m-MIMO idea, carried to its logical conclusion, is intelligent surfaces.

Numerous advantages of massive MIMO have been demonstrated; however, only a few initiatives have been taken to avoid negative effects from a base station that uses several antennas and surfaces all around the physical region [11]. A new concept of cell-free communication system architecture has been derived from distributed MIMO. Cell-free m-MIMO (CF-m-MIMO) is a new technology for next-generation terrestrial communication networks; it builds on coordinated multi-point and network MIMO techniques to achieve high spectrum efficiency, power efficiency, and network flexibility [12]. Multiple access points can be employed in CF-m-MIMO to collaboratively connect with users in a cell-free way. This technology can be used in wireless networks, taking advantage of ultra-dense deployment, very high-speed connections, and Line-of-Sight (LoS) connections. As a result, CF-m-MIMO can be used to create an efficient and resilient network [13].

High performance, coverage, capacity, interference management, and high-energy efficiency detection schemes are some of the key issues for wireless networks [8,14]. By enhancing the number of access points as well as using channel estimates in the distributed massive MIMO system, researchers are currently looking for the best receiver design [15]. However, this results in a significant increase in the complexity of the design structure [15]. A decrease in complexity for decoding can be made possible with the deployment of Low-Density Parity Check (LDPC) codes as a solution, compared with other coding techniques.

This article examines the architecture of a wide network, D-m MIMO, sub-networks, and the impact of effective elements, including access points, on various receivers within the broad network, as well as their responses within the D-m MIMO architecture. m-MIMO and CF-m-MIMO are terrestrial technologies that are also studied in the context of D-m MIMO techniques. The receiver structure and the main obstacles in receiver design for D-m MIMO will be evaluated.

Figure 1 shows the basic principle of the D-m MIMO technology, which combines distributed antennas at different geographic locations to form a distributed MIMO system.

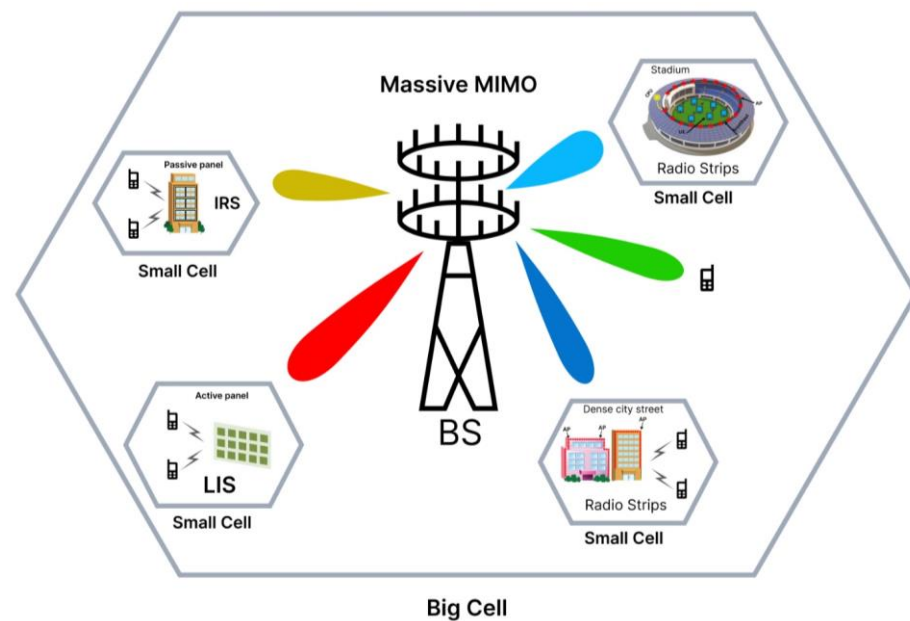

**Figure 1.** The basic principle of the D-m MIMO technology.

### 1.2. Objective and Organization of This Article

Previous works considered methods such as Successive Interference Cancellation (SIC), Beamforming Precoding, and Channel Estimation, achieving low complexity in Massive MIMO. Possible aims for a study on receiver designs for massive MIMO may involve an in-depth analysis of current literature regarding receiver designs for massive MIMO systems, outlining important research findings, approaches, and developments in the area and examining the obstacles and constraints linked to receiver design in massive MIMO systems, including difficulty with channel estimation, interference control, and computational complexity. This study is unique in its thorough examination of receiver design issues in distributed Massive MIMO systems and its proposal of creative ways to improve communication efficiency in these settings.

This article is divided as follows: Section 2 exposes the basic concepts in access points (APs) and Section 3 introduces the system model for D-m MIMO. Section 4 provides an overview of receiver design considerations for the D-m MIMO system. Section 5 shows the performance results obtained through Monte Carlo simulations. Finally, Section 6 suggests future research.

## 2. Essential Concepts

### 2.1. Effects of Access Points in D-m MIMO

Research on panel-based systems such as LIS/IRS, specifically focusing on the number of terminal densities, has demonstrated that increasing the number of APs leads to enhanced performance [10].

The impact of increasing the number of panels in a large intelligent surface (LIS) and the access points in radio stripes can vary, with both beneficial and detrimental impacts, contingent upon the application, objectives, and design factors.

Increased deployment of access points within the D-m MIMO system can enhance connection, reduce latency, and boost throughput for users, particularly in locations with a large concentration of users. Increasing the number of APs in a D-m MIMO can enhance the extent and reliability of network coverage, enhance its capacity, and reduce signal interference [16]. This is particularly significant in vast areas where dependable connection is vital. Effective design can reduce interference problems, improving network performance. Nevertheless, there exist prospective obstacles and factors to take into account. Handling a greater quantity of APs brings complexity in configuration, increases costs, can cause

interference and congestion problems, and may result in elevated power consumption, requiring the need for energy-efficiency considerations.

The process of creating a receiver for D-m MIMO systems requires tackling the difficulties presented by the large number of antennas, the distributed structure, and the requirement for effective signal processing. When constructing the receiver, it is important to consider efficient channel estimates, interference management, low-complexity processing, beamforming, and channel coding [17].

Ensuring low complexity in D-m MIMO systems is vital for practical deployment, particularly when the number of antennas grows. Channel coding is a proposed remedy for managing intricacy. Compared to other channel-coding techniques, LDPC codes are recommended for achieving reduced complexity in D-m MIMO systems. LDPC codes have exceptional error-correction capabilities with relatively little decoding intricacy, rendering them well-suited for D-m MIMO systems.

### 2.2. Independent LDPC Coding

LDPC is a linear error-correcting code used for transferring messages over noisy transmission channels. The LDPC coding method, developed by Gallager, is renowned for the effective decoding efficiency achieved by iterative decoding [18]. LDPC coding enables a coded MIMO system to attain a data rate that is very close to the Shannon limit. The concurrent processing of many streams is crucial for achieving Gbps wireless transmission [19]. LDPC coding is preferable for Gbps wireless transmission over Turbo coding because of its simplicity in implementation. LDPC codes possess remarkable error-correction capabilities with relatively low decoding complexity, making them highly suitable for D-m MIMO systems [20,21].

### 3. System Characterization

This paper examines the receiver design architecture for D-m MIMO systems. In line with Figure 2, the number of parallel data flows in a D-m MIMO is represented by the number  $T$  of transmitting antennas, while the degree of diversity is represented by the number  $R$  of receiving antennas. The receiving antenna count ( $R$ ) for multi-layer MIMO must match or exceed the sending antenna count ( $T$ ). There is an assumption that SC-FDE signals are related to Quadrature Phase Shift Keying (QPSK) modulation [22].

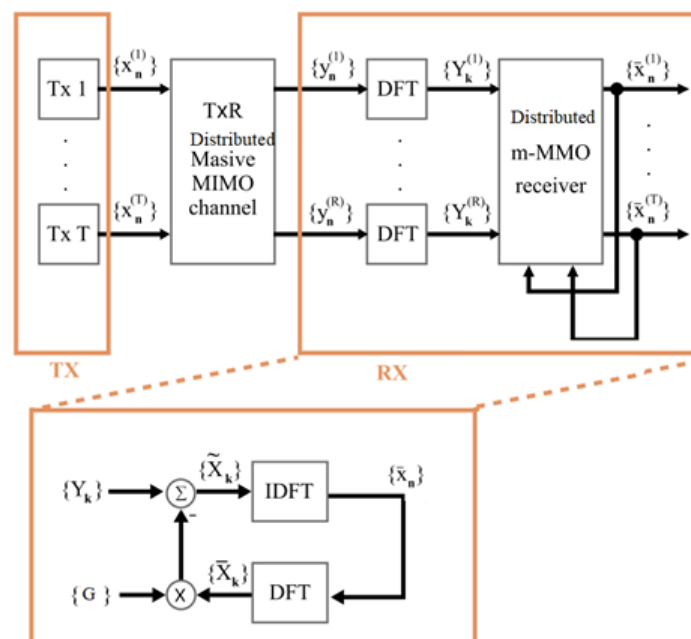

Figure 2. Block diagram of D-m MIMO system with SC-FDE signals.

The block of  $N$  data symbols that the  $t$ -th antenna sends is designated as  $x_n^{(t)}$ . After the time-domain block is subject to the discrete Fourier transform (DFT), the mapping between the time-domain signal and the frequency-domain signal for the transmitted block is specified as  $\{x_n^{(t)}; n = 0, 1, \dots, N - 1\} = IDFT\{X_k^{(t)}; k = 0, 1, \dots, N - 1\}$ . A comparable mapping is defined for the receiving block as  $\{y_n^{(r)}; k = 0, 1, \dots, N - 1\} = IDFT\{Y_k^{(r)}; k = 0, 1, \dots, N - 1\}$  [10].

After the cyclic prefix has been eliminated, and considering a cyclic prefix length greater than each channel's total channel impulse response, the received frequency-domain signal is obtained as follows:

$$\mathbf{Y}_k = [Y_k^{(1)}, \dots, Y_k^{(R)}]^T = \mathbf{H}_k \mathbf{X}_k + \mathbf{W}_k, \quad (1)$$

where  $\mathbf{X}_k = [X_k^{(1)}, \dots, X_k^{(T)}]^T$ . Moreover,  $\mathbf{H}_k$  denotes the  $T \times R$  channel frequency response matrix for the  $k$ -th subcarrier (assuming it is constant during a given block's transmission), with the  $(r, t)$ -th element  $H_k^{(t,r)}$ . Moreover,  $\{H_k; k = 0, 1, \dots, N - 1\} = DFT\{h_n; n = 0, 1, \dots, N - 1\}$  defines the mapping between the time domain and frequency domain. Additionally,  $\mathbf{W}_k$  represents the subcarriers' frequency-domain block channel noise [19].

Given a non-iterative receiver, the frequency-domain-estimated data symbols  $\tilde{\mathbf{X}} = [\tilde{X}_k^{(1)}, \dots, \tilde{X}_k^{(R)}]^T$  are transformed into  $\tilde{\mathbf{X}}_k = \mathbf{G} \times \mathbf{Y}_k$ , where  $\mathbf{G}$  is defined in the following for zero-forcing (ZF), minimum mean square error (MMSE), maximum ratio combining (MRC), and equal gain combining (EGC).

### 3.1. Zero Forcing

Zero forcing corresponds to a linear detection procedure. The pseudo-inverse of the signal will be applied to the received signal, to settle on a choice of one user equipment (UE) [23]. It has the disadvantage of presenting noise enhancement, which can be problematic for medium-to-high SNR (signal-to-noise ratio) levels.

$$\mathbf{G}_{ZF} = (\mathbf{H}^H \mathbf{H})^{-1} \mathbf{H}^H. \quad (2)$$

### 3.2. Minimum Mean Square Error

MMSE is also a linear detection strategy that presents an advantage compared to ZF, because it does not present noise enhancement. Similar to ZF, it requires the computation matrices for each frequency component [24], which is demanding.

$$\mathbf{G}_{MMSE} = \left( \mathbf{H}^H \mathbf{H} + \frac{1}{SNR} \mathbf{I}_N \right)^{-1}. \quad (3)$$

### 3.3. Maximum Ratio Combining

MRC is a linear processing technique that maximizes the SNR at the intended user by implementing the Hermitian of the channel matrix (conjugate transpose of channel matrix) [25]. Compared to ZF and MMSE, it presents an advantage, as it avoids the computation of the inversion of the channel matrix for each frequency component. The MRC processing employed by the BS is given by:

$$\mathbf{G}_{MRC} = \mathbf{H}^H. \quad (4)$$

### 3.4. Equal Gain Combining

EGC is a signal processing technique used in wireless communication systems to improve signal reception. EGC is a simple technique that combines multiple received

signals, often from multiple antennas, with equal weighting factors [26]. Similar to the MRC, it avoids computation of the channel inversion.

$$\mathbf{G}_{EGC} = \mathbf{A}_k^H \quad (5)$$

$$\text{with } \mathbf{A}_k = \begin{bmatrix} H_{k,(r,t)} \\ |H_{k,(r,t)}| \end{bmatrix}_{N_R \times N_T}.$$

The iterative block—decision feedback equalization (IB-DFE) is a very efficient receiver, commonly employed in conjunction with SC-FDE techniques. It consists of a strategy that uses both feedforward and feedback coefficients to analyze signals in the frequency domain, being an iterative receiver. This type of receiver demonstrates much better performance when compared to a non-iterative receiver. IB-DFE might be considered a form of turbo-equalization [27].

The MRC and EGC receivers, as stated before, are computationally simple but result in residual interference during decoding, especially for moderate-to-high  $T/R$  values. To resolve this problem, one potential approach relies on employing an iterative receiver, such as the IB-DFE, which integrates the function [28]

$$\tilde{\mathbf{X}}_k = \mathbf{G}_k^H \mathbf{Y}_k - \mathbf{C}_k \bar{\mathbf{X}}_k. \quad (6)$$

Note that, in the iterative receiver,  $\mathbf{G}_k^H$  corresponds to the feedforward coefficient, while  $\mathbf{C}_k$  corresponds to the feedback coefficient. The interference cancellation matrix  $\mathbf{C}_k$  can be computed as

$$\mathbf{C}_k = \mathbf{A}_k^H \mathbf{H}_k - \mathbf{I}, \quad (7)$$

where  $\mathbf{I}$  is an  $R \times R$  identity matrix. Using this iterative receiver, the residual interference generated in the decoding process of MRC and EGC can be mitigated.

#### 4. Receiver Design Considerations for D-m MIMO

Designing receivers for distributed massive MIMO systems is challenging because of the distinct properties of these systems. Factors affecting receiver design include channel estimates, interference control, and signal processing complexity. In order to design a MIMO receiver, one needs to balance performance, complexity, and practical concerns to meet communication objectives under various operating conditions. The creation of a receiver for D-m MIMO systems requires careful planning to optimize performance in terms of data throughput, reliability, and spectrum efficiency. In addition to channel estimation [23], interference mitigation [21] needs to be considered. Receiver architecture is also analyzed.

The design of a receiver architecture for D-m MIMO systems involves various fundamental ideas and factors.

##### 4.1. Methods for Combining Diversity

Receiver architectures need to efficiently integrate signals from multiple paths or antennas to enhance signal quality. MRC and EGC are often-employed methods to improve SNR and decrease bit error rates (BERs) [25].

##### 4.2. Spatial Multiplexing and Demultiplexing

Spatial multiplexing is the process of transmitting multiple data channels simultaneously using distinct antennas. Sophisticated signal processing techniques are required at the receiver to effectively distinguish these streams. ZF, MMSE, and SIC approaches are widely employed for this purpose [23].

##### 4.3. Coding/Decoding Complexity

D-m MIMO systems can significantly increase the computational complexity of signal decoding by processing many data channels at the same time. Efficient algorithms and cod-



ing implementations are essential for managing this complexity. LDPC code is introduced as a suitable suggestion.

#### 4.4. Channel Estimation Techniques

Having an accurate channel estimate is crucial for massive MIMO systems, as it requires establishing the channel state information (CSI) between the transmitter (base station [BS]) and the receiver (UE). Linear receivers, such as ZF or MMSE receivers, rely on precise channel estimates for efficient interference suppression and symbol identification. Various methods can be employed for this purpose, such as pilot-based estimate, least squares (LS) estimation, maximum likelihood (ML) estimation, and deep-learning-based estimation. This study relies on a pilot-based estimator.

The Pilot-Based Estimation approach discussed in this article involves the periodic transmission of known pilot symbols by the transmitter, which the receiver utilizes to estimate the channel response. The accuracy of this estimation relies on factors such as pilot signal design and interference from neighboring cells or users.

One of the adopted methodologies for D-m MIMO channel estimation involves the utilization of pilot signals or training sequences, followed by a Least Square (LS) channel estimation. For a D-m MIMO system with  $T$  transmitting antennas and  $R$  receiving antennas, the received signal can be represented by [29]

$$\mathbf{Y}_k = \mathbf{P}_k \mathbf{H}_k + \mathbf{W}_k, \quad (8)$$

where  $\mathbf{H}_k$  is the complex random channel matrix,  $\mathbf{P}_k = [P_1, \dots, P_K]$  is the complex vector of the transmitted symbols corresponding to the pilots, and  $\mathbf{W}_k = [W_1, \dots, W_K]$  is the complex zero-mean white noise vector and variance  $\sigma_w^2$ . Note that (8) is similar to (1), with the difference being that the data symbols  $\mathbf{X}_k$  are replaced by the pilot symbols  $\mathbf{P}_k$ . Matrix  $\mathbf{H}_k$  is considered to be random. Simultaneously, it is expected that any estimator of  $\mathbf{H}_k$  will provide an estimate of a specific realization of the random matrix that corresponds to the current block of the received data [30].

To estimate the channel matrix  $\mathbf{H}_k$ , defined as  $\widehat{\mathbf{H}}_k$ , it is necessary to broadcast  $N \geq T$  training signal vectors  $P_1, P_2, \dots, P_N$ .

According the least square (LS) algorithm, taking the knowledge of the pilot symbols  $\mathbf{P}_k$  and the received data  $\mathbf{Y}_k$ , the realization of channel matrix can be estimated as [31]

$$\widehat{\mathbf{H}}_k = \mathbf{Y}_k \hat{\mathbf{P}}_k, \quad (9)$$

where  $\hat{\mathbf{P}}_k = \mathbf{P}_k^H (\mathbf{P}_k \mathbf{P}_k^H)^{-1}$ , and where  $\mathbf{P}_k^H$  is the pseudoinverse of  $\mathbf{P}_k$ .

## 5. Performance Results

This section presents performance results for the proposed m-MIMO scheme, which is related to SC-FDE signals. We analyze the BER performances, which are represented as functions of  $E_b/N_0$ , where  $N_0$  refers to the one-sided power spectral density of the noise, and  $E_b$  represents the energy of the transmitted bits. The performance of this system was assessed through Monte Carlo simulations, employing QPSK modulation and a block length of  $N = 256$  symbols (identical outcomes were seen for different values of  $N$ , as long as  $N \gg 1$ ). The effective length of the blocks, measured in the number of symbols, is  $N$ . Each block lasts for a duration of 1 s, whereas the cyclic prefix has a duration of 0.125 s. A Rayleigh fading channel was assumed, consisting of 16 uncorrelated equal power paths. In our research, we examined a carrier frequency of 5 GHz. However, the signal processing approaches we used can be effectively applied independently of the chosen carrier frequency.

The adoption of MIMO with spatial multiplexing involves the use of multi-layer transmission. Results involving  $T \times R$  ( $T$  transmitting antennas and  $R$  receiving antennas) indicate the presence of  $T$  concurrent symbol streams, resulting in a  $T$ -times increase in

symbol rate. In the context of MIMO multi-layer transmission, it is necessary for  $R$  to be equal to or greater than  $T$  for the detection to be feasible (Figure 3).

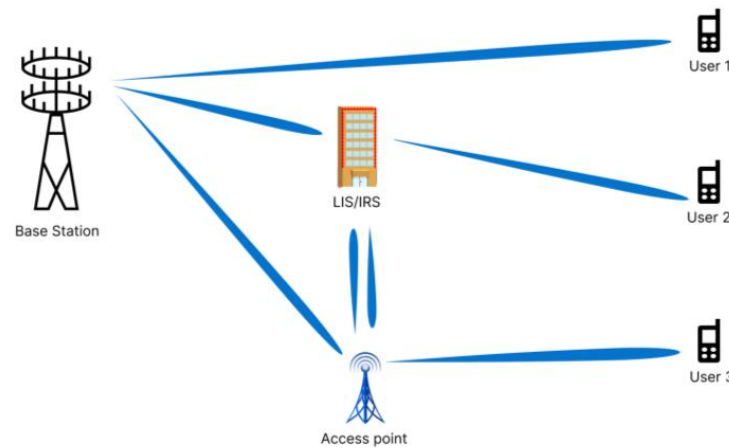

Figure 3. Block diagram of receiver design for D-m MIMO system.

Table 1 presents a list of baseline simulations utilized in the different graphics of this section.

Table 1. The baselines used in simulations.

Figure	Diversity	Number of Users (Including the Reference User)	Selective APs	Channel Estimation	Encoding (LDPC)	Objective
Figure 4	2 × 4 MIMO 4 × 8 MIMO 8 × 16 MIMO	2	-	No	No	Show that performance is improved with the use of higher MIMO diversity. Show that better results are obtained with MMSE and ZF receivers.
Figure 5	8 × 64 MIMO	2	4	No	No	Show that increasing the number of APs leads to improved performance. Show that the best results are obtained with MMSE and ZF
Figure 6	8 × 64 MIMO	2	4 e 16	No	No	Show that increasing APs leads to enhancements in performance, with higher effectiveness under MRC.
Figure 7	8 × 64 MIMO	2, 4 e 8	-	No	No	Show the difference in performance for different numbers of users.
Figure 8	16 × 64 MIMO	2	-	No	Yes and No	Show that performance improves with LDPC codes, compared to the uncoded system.
Figure 9	16 × 64 MIMO	2	-	Yes and No	No	Show the difference in performance with and without channel estimate.

Figure 4 shows the performance results for the D-m MIMO system in different scenarios: 2 transmit antennas and 4 receiver antennas (2 × 4), 4 transmit antennas and 8 receiver antennas (4 × 8), and 8 transmit antennas and 16 receive antennas (8 × 16). All these configurations consider two users, without LDPC codes, being associated with four receiver types: ZF, MMSE, MRC, and EGC. The augmentation of the number of receiving antennas is expected to enhance performance outcomes, while a degradation is expected with the increase in the number of transmitting antennas (corresponding to an increase in the symbols rate). According to the BER information, an increase in  $T$  and  $R$  shows greater efficiency. The ZF and MMSE demonstrated a performance that is almost on par with that of the Matched Filter Bank (MFB) for 8 × 16 MIMO. Note that the MFB curve can be seen as a lower bound, corresponding to the system without any inter-symbol interference. Moreover, the MRC exhibited somewhat superior efficacy in comparison to the EGC. The advantage of the MRC and EGC relies on their simplicity, as compared to ZF and MRC receivers.



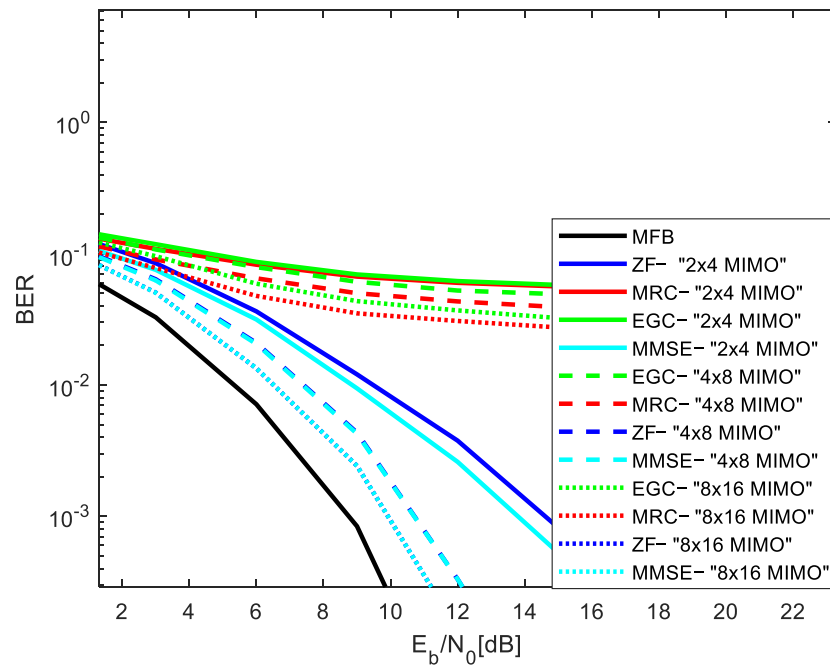

Figure 4. BER result for comparing  $2 \times 4$  MIMO,  $4 \times 8$  MIMO, and  $8 \times 16$  MIMO systems.

A basic MIMO system without APs and with four APs is shown in Figure 5 for the  $8 \times 64$  MIMO configuration, for four different types of receivers: ZF, MMSE, MRC, and EGC. As before, LDPC codes are not considered in these results. An increase in APs leads to improved performance results. This highlights the importance of considering optimal deployment strategies to achieve the desired BER performance in distributed massive MIMO systems.

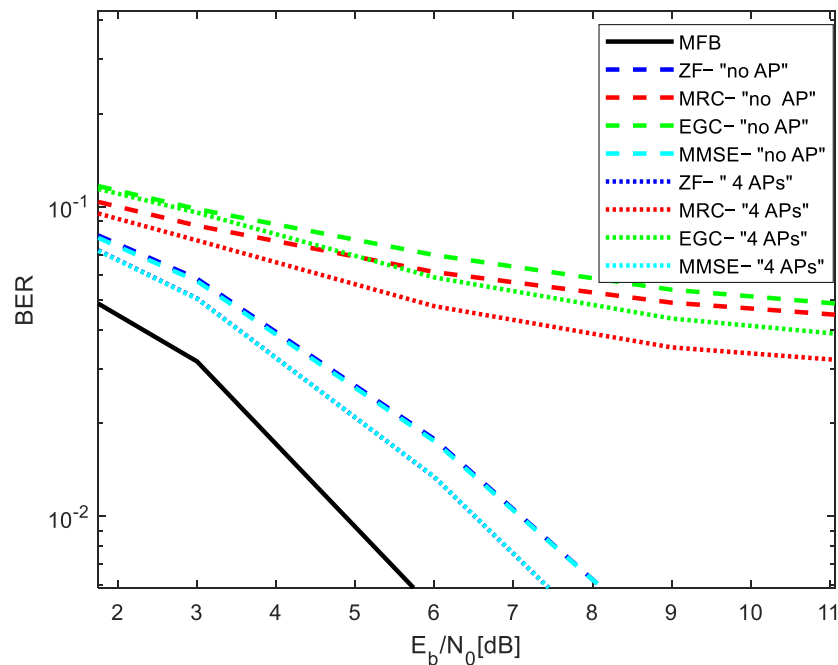
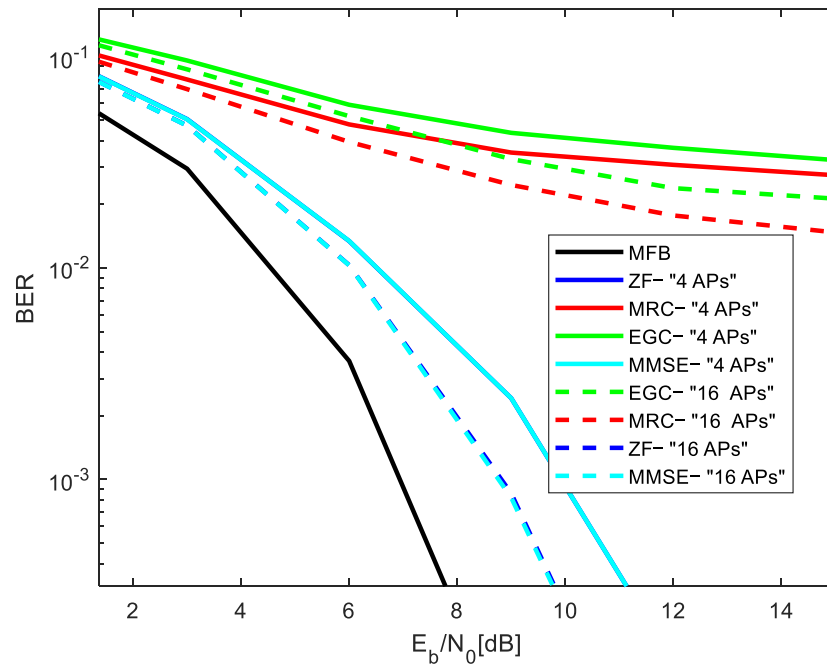

Figure 5. BER result for comparing AP effects for the  $8 \times 64$  MIMO configuration.

Figure 6 compares the performance results without LDPC codes in the D-m MIMO system, assuming the  $8 \times 64$  MIMO configuration (8 transmit antennas and 64 receiver antennas), with 4 and 16 APs and different receiver types: ZF, MMSE, EGC, and MRC. The performance is constrained in the case of APs as there are fewer spatially different pathways

available, unlike the 16 APs scenario. Similar to the previous figure, the ZF receiver exhibited a performance that was nearly equivalent to that of the MFB. Furthermore, the MRC demonstrated a somewhat higher effectiveness when compared to the EGC.



**Figure 6.** BER results for the impact of the number of APs on the system, for the  $8 \times 64$  MIMO configuration.

Figure 7 illustrates the performance results of the  $8 \times 64$  MIMO configuration (8 transmit antennas and 64 receiver antennas) with 2, 4, and 8 users, without the use of LDPC codes. As anticipated, increasing the number of users leads to an overall decrease in performance. However, it is noticeable that, in all results, the decline in performance is small for the MMSE and ZF receivers but more noticeable for the MRC and EGC receiver types.

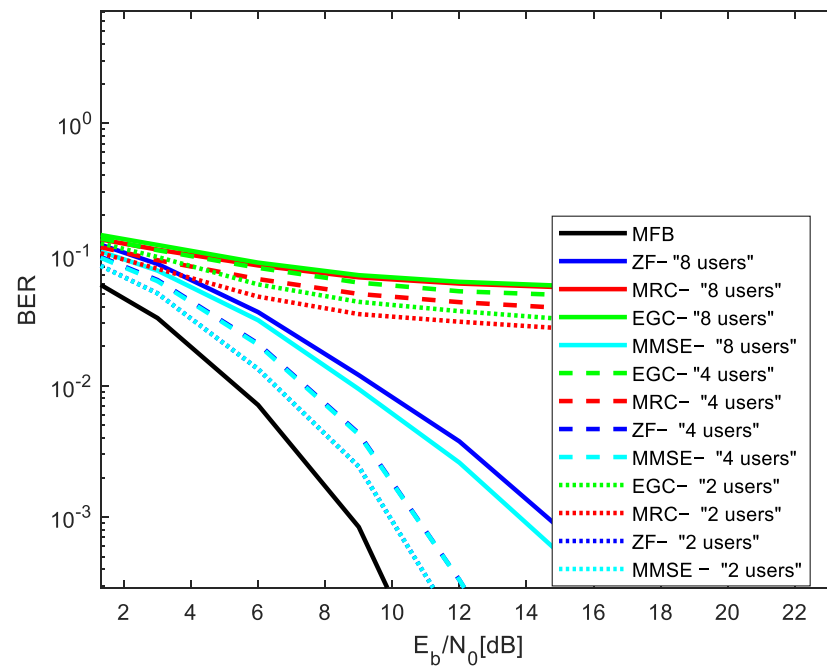

**Figure 7.** BER results for the impact of the number of users on the system.

Figure 8 illustrates the BER outcomes on the impact of LDPC codes, for the  $16 \times 64$  MIMO configuration, considering 16 APs. LDPC coding is suitable for distributed massive MIMO systems to achieve low complexity with coding, particularly as the number of antennas increases. Based on the simulation data, the LDPC code demonstrates the highest level of performance.

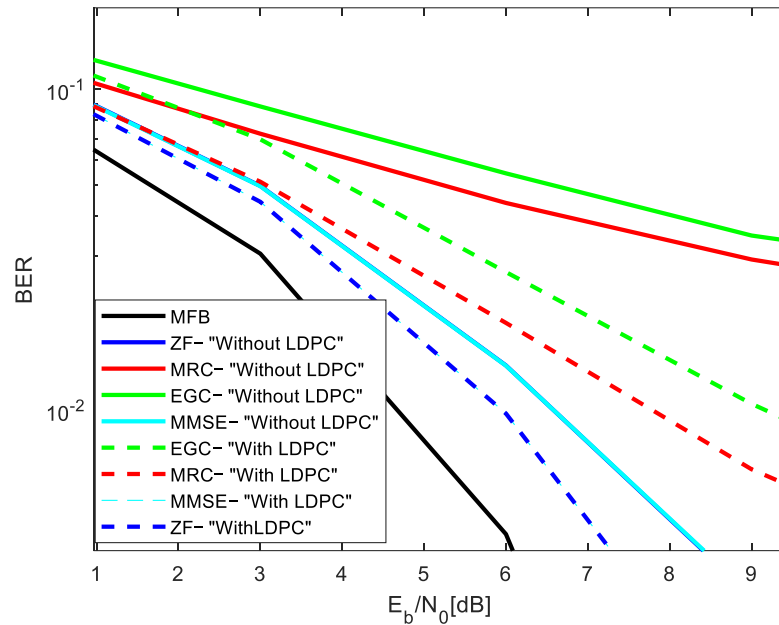

Figure 8. BER results for the effect of the LDPC code on the  $16 \times 64$  MIMO configuration with 16 APs.

Figure 9 shows the performance with and without channel estimates (CEs), without LDPC codes for the  $16 \times 64$  MIMO configuration. These results demonstrate that integrating CE enables receivers to adjust to changing channel circumstances. It is noticeable that, despite the use of CE, the performances obtained are very close to those obtained assuming ideal CE (without CE).

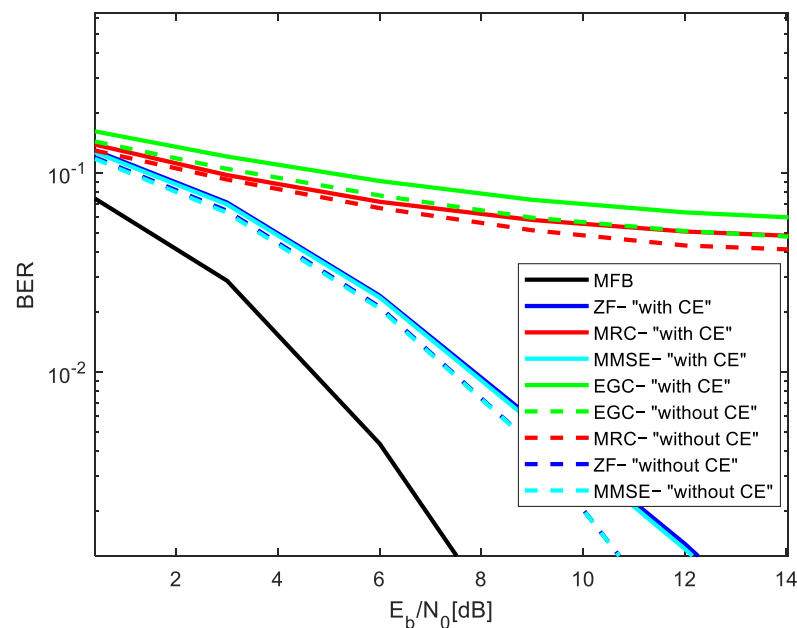

Figure 9. BER results for the effect of channel estimates for the  $16 \times 64$  MIMO configuration.

## 6. Benchmarking

In this section, we provide a comprehensive comparison of the four receiver architectures analyzed in this study. The Table 2 highlights various design approaches and performance metrics for each architecture, allowing for an easy comparison of their strengths and weaknesses.

**Table 2.** Benchmarking used in simulations.

Receiver Architecture	Design Approach	Key Performance Metrics	Advantages	Disadvantages
ZF	Linear precoding	<ul style="list-style-type: none"> <li>- Spectral efficiency</li> <li>- Bit error rate</li> <li>- Computational complexity</li> </ul>	<ul style="list-style-type: none"> <li>- Good performance</li> <li>- Good cancellation of inter-symbol interference</li> </ul>	<ul style="list-style-type: none"> <li>- Presents noise enhancement</li> <li>- Requires accurate channel-state information</li> <li>- High computational complexity</li> </ul>
MMSE	Statistical precoding	<ul style="list-style-type: none"> <li>- Spectral efficiency</li> <li>- Bit error rate</li> <li>- Computational complexity</li> </ul>	<ul style="list-style-type: none"> <li>- Good performance</li> <li>- Robust to imperfect channel knowledge</li> <li>- Better noise suppression compared to ZF</li> </ul>	<ul style="list-style-type: none"> <li>- High computational complexity</li> </ul>
MRC	Weighted combining based on channel gains	<ul style="list-style-type: none"> <li>- Spectral efficiency</li> <li>- Bit error rate</li> <li>- Computational complexity</li> </ul>	<ul style="list-style-type: none"> <li>- Simple implementation</li> <li>- Low complexity optimal in certain scenarios</li> <li>- Good performance in high SNR environments</li> </ul>	<ul style="list-style-type: none"> <li>- Lower performance compared to ZF and MMSE</li> </ul>
EGC	Combining multiple signals	<ul style="list-style-type: none"> <li>- Bit error rate</li> <li>- Computational complexity</li> </ul>	<ul style="list-style-type: none"> <li>- Simple implementation</li> <li>- Low complexity</li> </ul>	<ul style="list-style-type: none"> <li>- Lower performance compared to MRC, ZF, and MMSE</li> </ul>

## 7. Conclusions

This article presents the findings of a study conducted on a receiver design in a distributed massive MIMO system. As a significant contribution, it studies how the number of access points impacts the performance, for different receiver types, with and without LDPC coding. The SC-FDE transmission method was assumed to be associated with four types of receivers: ZF, MMSE, MRC, and EGC. This comparative analysis in all receiver types and with various scenarios, consisting of impact node APs, LDPC, and channel estimates, contributes to the novelty of the study in comparison to the previous literature, by providing insights into the performance and applicability of different receiver algorithms in D-m MIMO systems.

One advantage of the D-m MIMO system relies on its simplicity. The performance results showed improved efficiency under an increase in the number of antennas and APs. Moreover, it was shown that the ZF and MMSE receivers achieve performances very close to the MFB, while the EGC receiver demonstrates the poorest performance. The MRC receiver can be viewed as a trade-off between performance and simplicity. It is worth noting that ZF and MMSE are considered complex receivers due to the requirement that the inverse channel matrix be computed for each frequency component, which is avoided in the case of MRC and EGC receivers.

Studies have shown that increasing the number of receiving antennas enhances the performance of D-m MIMO systems, associated with SC-FDE transmission method. This is valid with and without LDPC codes. Meanwhile, the ZF and MMSE receivers were found to achieve the best overall performance; the MRC receiver is a good choice for enhancing future cellular communications, especially where low complexity is essential.

## 8. Future Research

Future investigations will involve the incorporation of OFDM transmission in the existing research, instead of SC-FDE. This entails assessing the influence of pilot contami-

nation, channel estimation, and minimizing interference to achieve reduced complexity in the receiver design in D-m MIMO. Moreover, future work will investigate the performance trade-offs and computational complexity associated with higher-order modulation schemes (e.g., 16-QAM, 64-QAM) in next-generation communication systems and explore advanced digital signal processing techniques to mitigate impairments arising from high-order modulations.

**Author Contributions:** Conceptualization, R.D.; Methodology, M.M.d.S.; Investigation, A.G. All authors have read and agreed to the published version of the manuscript.

**Funding:** This work is funded by FCT/MCTES through national funds and when applicable co-funded by EU funds under the projects UIDB/EEA/50008/2020 and 2022.03897. PTDC.

**Data Availability Statement:** Obtained making use of Monte Carlo simulations, implemented using MATLAB R2024a.

**Acknowledgments:** We acknowledge the support of FCT/MCTES, as described above under “Funding”. We also acknowledge the support of Autonomia TechLab for providing an interesting environment to carry out this research.

**Conflicts of Interest:** The authors declare no conflicts of interest.

## References

1. Agiwal, M.; Roy, A.; Saxena, N. Next Generation 5G Wireless Networks: A Comprehensive Survey. *IEEE Commun. Surv. Tutor.* **2016**, *18*, 1804–1837. [[CrossRef](#)]
2. Dajer, M.; Ma, Z.; Piazzzi, L.; Prasad, N.; Qi, X.-F.; Sheen, B.; Yang, J.; Yue, G. Reconfigurable intelligent surface: Design the channel—A new opportunity for future wireless networks. *Digit. Commun. Networks* **2021**, *8*, 87–104. [[CrossRef](#)]
3. Gong, S.; Lu, X.; Hoang, D.T.; Niyato, D.; Shu, L.; Kim, D.I.; Liang, Y.-C. Toward Smart Wireless Communications via Intelligent Reflecting Surfaces: A Contemporary Survey. *IEEE Commun. Surv. Tutor.* **2020**, *22*, 2283–2314. [[CrossRef](#)]
4. Zhao, J.; Liu, Y. Survey of Intelligent Reflecting Surfaces (IRSs): Towards 6G Wireless Communication Networks. *arXiv* **2019**, arXiv:1907.04789.
5. Pavia, J.P.; Velez, V.; Souto, N.; da Silva, M.M.; Correia, A. System-Level Assessment of massive MIMO and RIS in C-RAN and IoT scenarios in sub-6 GHz, mm-Wave and THz bands. *Appl. Sci.* **2024**, *14*, 1098. [[CrossRef](#)]
6. Gashtasbi, A.; da Silva, M.M.; Dinis, R. IRS, LIS, and Radio Stripes-Aided Wireless Communications: A Tutorial. *Appl. Sci.* **2022**, *12*, 12696. [[CrossRef](#)]
7. da Silva, M.M.; Guerreiro, J. On the 5G and beyond. *Appl. Sci.* **2020**, *10*, 7091. [[CrossRef](#)]
8. Al-Jarrah, M.; Alsusa, E.; Al-Dweik, A.; So, D.K.C. Capacity Analysis of IRS-Based UAV Communications with Imperfect Phase Compensation. *IEEE Wirel. Commun. Lett.* **2021**, *10*, 1479–1483. [[CrossRef](#)]
9. Pereira, A.; Rusek, F.; Gomes, M.; Dinis, R. Deployment Strategies for Large Intelligent Surfaces. *IEEE Access* **2022**, *10*, 61753–61768. [[CrossRef](#)]
10. Pereira, A.; Rusek, F.; Gomes, M.; Dinis, R. On the Complexity Requirements of a Panel-Based Large Intelligent Surface. In Proceedings of the GLOBECOM 2020—2020 IEEE Global Communications Conference, Taipei, China, 7–11 December 2020; pp. 1–6.
11. Hu, S.; Rusek, F.; Edfors, O. The Potential of Using Large Antenna Arrays on Intelligent Surfaces. In Proceedings of the 2017 IEEE 85th Vehicular Technology Conference (VTC Spring), Sydney, Australia, 4–7 June 2017; pp. 1–6.
12. Conceição, F.; Gomes, M.; Silva, V.; Dinis, R.; Antunes, C.H. Bi-Objective Power Optimization of Radio Stripe Uplink Communications. *Electronics* **2022**, *11*, 876. [[CrossRef](#)]
13. Shaik, Z.H.; Bjornson, E.; Larsson, E.G. Cell-Free Massive MIMO with Radio Stripes and Sequential Uplink Processing. In Proceedings of the 2020 IEEE International Conference on Communications Workshops (ICC Workshops), Dublin, Ireland, 7–11 June 2020; pp. 1–6.
14. Ngo, H.Q.; Tran, L.-N.; Duong, T.Q.; Matthaiou, M.; Larsson, E.G. On the Total Energy Efficiency of Cell-Free Massive MIMO. *IEEE Trans. Green Commun. Netw.* **2017**, *2*, 25–39. [[CrossRef](#)]
15. Pereira, A.; Rusek, F.; Gomes, M.; Dinis, R. A Low Complexity Sequential Resource Allocation for Panel-Based LIS Surfaces. In Proceedings of the 2022 IEEE 95th Vehicular Technology Conference (VTC2022-Spring), Helsinki, Finland, 19–22 June 2022.
16. Sanchez, J.R.; Rusek, F.; Edfors, O.; Liu, L. An Iterative Interference Cancellation Algorithm for Large Intelligent Surfaces. *arXiv* **2019**, arXiv:1911.10804v1.
17. Kundu, N.K.; McKay, M.R. Channel Estimation for Large Intelligent Surface Aided MISO Communications: From LMMSE to Deep Learning Solutions. *arXiv* **2020**, arXiv:2011.07265.
18. Fang, Y.; Bi, G.; Guan, Y.L.; Lau, F.C.M. A Survey on Photograph LDPC Codes and Their Applications. *IEEE Commun.-Tion Surv. Tutor.* **2015**, *17*, 1989–2016. [[CrossRef](#)]

19. Gashtasbi, A.; da Silva, M.M.; Dinis, R.; Guerreiro, J. On the Performance of LDPC-Coded Large Intelligent Antenna System. *Appl. Sci.* **2023**, *13*, 4738. [[CrossRef](#)]
20. Alghonaim, E.; Landolsi, M.A.; El-Maleh, A. Improving BER Performance of LDPC Codes Based on Intermediate Decoding Results. In Proceedings of the 2007 IEEE International Conference on Signal Processing and Communications (ICSPC 2007), Dubai, United Arab Emirates, 24–27 November 2007.
21. Marques da Silva, M.; Dinis, R.; Martins, G. On the Performance of LDPC-Coded Massive MIMO Schemes with Power-Ordered NOMA Techniques. *Appl. Sci.* **2021**, *11*, 8684. [[CrossRef](#)]
22. Ma, H.; Fang, Y.; Chen, P.; Mumtaz, S.; Li, Y. A Novel Differential Chaos Shift Keying Scheme with Multidimensional Index Modulation. *IEEE Trans. Wirel. Commun.* **2022**, *22*, 237–256. [[CrossRef](#)]
23. da Silva, M.M.; Dinis, R.; Guerreiro, J. A Low Complexity Channel Estimation and Detection for Massive MIMO Using SC-FDE. *Telecom* **2020**, *1*, 3–17. [[CrossRef](#)]
24. Sanchez, J.R.; Rusek, F.; Edfors, O.; Liu, L. Distributed and Scalable Uplink Processing for LIS: Algorithm, Architecture, and Design Trade-offs. *arXiv* **2020**, arXiv:2012.05296v1.
25. Harika, A.; Biradar, R.L. MIMO OFDM with index modulation for 5G networks. *Mater. Today Proc.* **2021**. [[CrossRef](#)]
26. Wang, J.; Baykas, T.; Funada, R.; Sum, C.-S.; Rahman, A.; Lan, Z.; Harada, H.; Kato, S. A SNR Mapping Scheme for ZF/MMSE Based SC-FDE Structured WPANs. In Proceedings of the 2009 IEEE 69th Vehicular Technology Conference Spring, Barcelona, Spain, 26–29 April 2009; pp. 1–5.
27. Borges, D.; Montezuma, P.; Ferreira, A.; Dinis, R. Two Low Complexity MRC and EGC Based Receivers for SC-FDE Modulations with Massive MIMO Schemes. *J. Signal Process. Syst.* **2018**, *90*, 1357–1367. [[CrossRef](#)]
28. Gupta, S.; Bajaj, R.; Jadon, J.S.; Arora, N. Analysis and comparison of transmit diversity scheme using MRC and EGC. In Proceedings of the 2017 International Conference On Smart Technologies For Smart Nation (SmartTechCon), Bengaluru, India, 17–19 August 2017; pp. 212–216.
29. Biguesh, M.; Gershman, A.B. Training-Based MIMO Channel Estimation: A Study of Estimator Tradeoffs and Optimal Training Signals. *IEEE Trans. Signal Process.* **2006**, *54*, 884–893. [[CrossRef](#)]
30. Imani, M.; Bakhshi, H. Training Based Channel Estimation in MIMO-OFDM Systems. *Commun. Netw.* **2012**, *4*, 54–60. [[CrossRef](#)]
31. Do, D.-T.; Vu, D.-T. A new training sequence for secure channel estimation in MIMO systems. In Proceedings of the 2010 3rd IEEE International Conference on Computer Science and Information Technology (ICCSIT 2010), Chengdu, China, 9–11 July 2010. [[CrossRef](#)]

**Disclaimer/Publisher’s Note:** The statements, opinions and data contained in all publications are solely those of the individual author(s) and contributor(s) and not of MDPI and/or the editor(s). MDPI and/or the editor(s) disclaim responsibility for any injury to people or property resulting from any ideas, methods, instructions or products referred to in the content.