

Article

Case, Concord and the Emergence of Default

Luis López

Hispanic and Italian Studies, University of Illinois, Chicago, IL 60607, USA; luislope@uic.edu

Received: 24 June 2019; Accepted: 24 March 2020; Published: 9 April 2020



Abstract: This article provides initial evidence that the head K, which may spell out as case morphology, drives the operations of concord within the noun phrase. Evidence for this claim comes from three code-switching varieties: Basque/Spanish, German/Turkish and Russian/Kazakh. By placing the switch at the border between case morphology and the rest of the noun phrase the properties of K can be isolated and inspected. We find that if K is drawn from the lexicon of a non-concord language, constituents within the noun phrase adopt a default morphology. It is suggested that the data presented in this paper provide evidence for approaches that take Concord to be a form of Agree (probe, goal) and against an approach that takes it to be the result of feature percolation from the bottom up. An analysis of default morphology is proposed that argues that default forms are inserted as vocabulary items in syntactic terminals that, as a result of a failure of Agree, are populated with unvalued features.

Keywords: code-switching; concord; noun phrase; distributed morphology; default exponent; Spanish/Basque; Kazakh/Russian; German/Turkish

1. Introduction

Concord consists of the sharing of features among the constituents in a noun phrase. The richest forms of concord involve case, gender and number. Example (1a) is a Russian noun phrase; the noun ‘*ploshod’*, ‘square’, which is feminine, bears no number or case morphology, which signals that it is singular as well as accusative or nominative. The adjective *star* ‘old’ does have a suffix that carries the information accusative, feminine and singular in concord with the noun. Finally, the deictic *etu* carries the same case, gender and number information. Example (1b) is a Spanish example; the inflection on the adjective and determiner—and, in this case, also the noun—inflects for gender and number:

(1) a. Russian

| | | |
|-----------------|-----------------|----------------------|
| <i>etu</i> | <i>star-uyu</i> | <i>ploshod’-Ø</i> |
| this.acc.f.sg | old-acc.f.sg | square(f.sg)-ACC/NOM |
| this old square | | |

b. Spanish

| | | |
|--------------|---------------|---------------|
| <i>est-a</i> | <i>viej-a</i> | <i>plaz-a</i> |
| this-F.SG | old-F.SG | square-F.SG |

This exploratory article presents initial empirical evidence that concord is directly dependent on case, to the extent that when the properties of the case marker are altered, concord may also be altered or even disappear. Following a long tradition (see, for instance, (Bittner and Hale 1992)), I assume that case markers are the spell-out of the syntactic head K.

Additionally, this article intends to contribute to a current debate concerning the mechanism of concord. The debate revolves around whether concord should be assimilated to the Agree mechanism laid out in (Chomsky 2000), as in (Carstens 2001), or whether we should instead postulate an alternative mechanism of percolation, as in (Norris 2014). Let us call them the Concord-as-Agree and the Concord-as-Percolation

hypotheses, respectively. I propose in this article that the data presented here argues in favor of the Concord-as-Agree hypothesis, with K as the only probe responsible for concord within the noun phrase.

In the absence of the proper form of K, there is no concord. Consequently, the gender and number features of the constituents in the noun phrase end up unvalued/unchecked and adopt a form of default morphology. This leads to the second goal of this article: An exploration of how default morphology comes to be and how unvalued features end up with default morphology.

Let me now introduce my theoretical assumptions. I assume that the structure in the noun phrase is as in Example (2) (for references on work that leads to this structure, see (Alexiadou et al. 2007)).

(2) K [D [Num [n \checkmark]]]

K is a head that selects the DP and may spell out as case morphology. D consists of the feature (IN)DEFINITE and selects Num, which consists of the feature NUMBER. A little *n* categorizes the root and bears a valued GENDER feature and \checkmark is a category-less root. Likewise, I take it that a verb is forming by merging a root and a little *v* and an adjective consists of a little *a* and a root (Marantz 1997).

Syntactic dependencies are built by means of Agree (p,g), as in (Chomsky 2000). A probe with an unvalued feature—which I annotate as [F:_]—inspects its c-command domain in search of a valued version of the same feature: [F:val]. Once the feature is found, it is copied on the probe. If the probe can value an unvalued feature on the goal this may take place at this point too. Probing is limited by phase boundaries only. I also adopt the assumption that feature valuation may fail (López 2007; Preminger 2014) with the result that a [F:_] may reach spell-out without crashing the syntactic derivation. Additional details of the valuation mechanism are introduced as needed.

Regarding the spell-out of syntactic terminals, I adopt the assumptions drawn from Distributed Morphology (Halle and Marantz 1993; Harris 1994; Embick 2015). Thus, I take it that Syntax manipulates abstract features and bundles of features. The set of features that go into the computational system is called List 1. Once the syntactic derivation for a particular domain is finished, the result is fed to the module PF. PF contains morphological rules of fusion and local dislocation and a set of *Vocabulary Insertion Rules* that spell out the proper exponents—vocabulary items in Distributed Morphology parlance—for the syntactic terminals. The set of exponents is referred to as List 2. A question that, to my knowledge, has not been discussed in Distributed Morphology is if or how unvalued features find vocabulary items—one of the topics of this article.

The data brought in to develop the argument come from three code-switching varieties. Code-switching can be defined, very broadly, as the integration of linguistic material from two languages in one speech act by early, extremely fluent, bilingual speakers. Code-switching data are very helpful in linguistic theorizing because code-switching allows us to disassemble the pieces of the puzzle and isolate the relevant variables. The method employed in this paper consists of inspecting examples in which the case morphology comes from a language without concord while the rest of the noun phrase comes from a language with concord. This is schematized in Example (3).

(3)

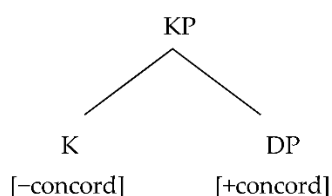

I find that in this context, concord in the DP disappears and it is replaced with a collection of default forms devoid of number and gender values. These forms, by hypothesis, spell out unvalued features.

The marriage of distributed morphology with code-switching has yielded an interesting crop of papers in recent years, among which: (Alexiadou et al. 2015; Áfarli 2015; Grimstad et al. 2014; Riksem et al. 2019). However, I think it is fair to say that code-switching is not yet part of the syllabus of linguistics

programs. Thus, I say a few words here about code-switching and its role in linguistic theory. For our purpose, we are particularly interested in forms of code-switching that seem to incorporate apparently heterogeneous material seamlessly. The following is an example produced by a German/Spanish bilingual:¹

(4) *German/Spanish*

| | | | | | | | |
|--------------|--------------------|------------------|---------------|--------------|-------------|----------------------------|----------|
| <i>Wir</i> | <i>utilisieren</i> | <i>spanische</i> | <i>Worte,</i> | <i>die</i> | <i>dann</i> | <i>alemanisiert werden</i> | <i>y</i> |
| we | use | Spanish | words, | that | then | germanized become | and |
| <i>hacen</i> | <i>klingen</i> | <i>un</i> | <i>poco</i> | <i>raro.</i> | | | |
| do | sound | a | bit | strange | | | |

'We use Spanish words that then are germanized and sound a little funny.'

(González-Vilbazo 2005, p. 1)

Code-switching is a component of the I-language of many bilingual speakers and it is as rule-governed as any other form of I-language. Consequently, bilingual code-switchers are able to provide acceptability judgments on code-switched expressions (see (Poplack 1980; MacSwan 1999, 2000) among many others) and these judgments can be taken as part of the empirical base for linguistic theory. For instance, (Finer 2014) reports that Korean/English bilinguals accepted Example (5a) and rejected Example (5b):

(5) *English/Korean*

a. I wonder he bought *muet* yesterday.
what

b. * I wonder *muet* he bought yesterday.

(Finer 2014, p. 55)

The Korean *wh*-phrase stays in situ, as in monolingual Korean, despite the fact that the rest of the sentence is made up exclusively of English items. This constitutes interesting data for any analysis of *wh*-in-situ. In particular, those analyses based on attraction of the *wh*-phrase by C (Chomsky 2000) would seem to have found an empirical challenge in Example (5). Likewise, (Richards 2010, 2015)'s proposal that *wh*-in situ is an alternative strategy to satisfy the prosodic requirement that C and the *wh*-phrase find themselves in the same minor phrase could be tested against examples such as Example (5).

Likewise, scholars interested in complementizer-trace (comp-t) effects may take into consideration the judgment reported in Example (6) (from (Ebert and Hoot 2018)). Spanish/English bilingual speakers who had native-like judgments on comp-t effects in both languages (rejection in English, acceptance in Spanish) rejected a sentence like the following, in which the complementizer is Spanish but the subordinate T is English:

(6) *Spanish/English*

* Quién asumieron los maestros que had read the text before the test?
who assumed the teachers that

(Ebert and Hoot 2018, p. 112)

In a bilingual sentence, a comp-t violation was accepted only if both the complementizer and the auxiliary in the subordinate clause were in Spanish—any other combination of C and the auxiliary was deemed unacceptable. Thus, this investigation provides valuable new insight into the origins of the comp-t effect.²

¹ In the code-switching examples I use the conventions usually employed in the literature. One of the two languages appears in italics. The choice of which language appears in italics is random.

² Nonetheless, sometimes scholars have expressed doubts that reliable acceptability judgments on code-switching can be obtained (Gardner-Chloros 2009; Mahootian and Santorini 1996). However, it is clear to me that enough literature has been published on various aspects of the formal syntax and morphology of code-switching with a variety of methods of data elicitation that this question should be put to rest definitely (for additional discussion on acceptability judgments and

Finally, let me end this section with a few words on data collection, a controversial issue in code-switching research (see, for instance, the contributions in (Gullberg et al. 2009; Munarriz-Ibarrola et al. 2018)). The data in this article are drawn from Basque/Spanish, Russian/Kazakh and German/Turkish bilinguals. The Russian/Kazakh data, as quoted in this article, comes from (Auer and Muhamedova 2005; Muhamedova 2006) and my discussion is based on (Auer and Muhamedova 2005) description and analysis. The examples are drawn from an oral corpus based on conversations with 31 Kazakhs, built by Raihan Muhamedova and an assistant during her field work in Almaty. These bilinguals are native-like, balanced bilinguals, according to Muhamedova's description, since they have learned Russian and Kazakh early in life and have sustained literacy and proficiency in both languages into adulthood. With one exception, the subjects are all adult and the gender is balanced with 15 men and 16 women. I found no information regarding education level or type of employment.

For the Basque/Spanish data, I consulted with two speakers from Gernika, both native-like, early-sequential bilinguals in Spanish and Basque and frequent code-switchers. They are female and in their late 20s. For the German/Turkish data I consulted with one person who resides in Stuttgart and another one who lives in Siegen via Skype. They are also native-like in both languages and early-sequential bilinguals. They are also female and their ages range from late 20s to late 30s. All four consultants are highly educated with careers in education.

The examples that I report on in this paper involve having a case suffix, and sometimes number morphology, in one language while keeping the rest of the noun phrase in the other and check for the possibility of concord—this involved several combinations of gender and number features on noun, adjective and, occasionally, determiner. In order to obtain the data on Basque/Spanish and German/Turkish code-switching reported here I worked with one of the speakers of each language pair over several sessions in which we tried several types of sentences until generalizations started to emerge. This process was necessary for two reasons. First, the consultants had to patiently educate me about features of their native languages that one cannot find in descriptive grammars: What kinds of words would be felicitous or how sentences could be constructed so they would sound idiomatic. Second, I needed some time to “train” my consultants to focus on the features that I was interested in so they could avoid rejecting sentences on the basis of irrelevant features (one of my consultants rejected all examples I was giving her, to my puzzlement, until we realized that I had neglected to take vowel harmony into consideration when constructing the examples). This “training” was crucial: I wanted to check what morphology the noun and adjective in L_x exhibit when selected by a case marker of L_y and so I tried several possible combinations of gender and number and tested them in isolation and in pairs. Once some sentences were configured, a second speaker was consulted in some detail. With the Basque/Spanish data, some members of my consultant's social group were also consulted more casually. The judgments reported here were consistent for the speakers consulted.

Given the limited scope of my field work and the smaller number of speakers consulted, this paper should be regarded as exploratory. I am encouraged by the fact that three groups of bilingual code-switchers converge on accepting, rejecting or producing certain types of sentences. I submit that this convergence reveals a genuine linguistic property.

The rest of the article is organized as follows. In Section 2 I present the data that supports the hypotheses laid out here. In Section 3 I present an alternative interpretation of the data and show that it does not work. In Section 4 I argue that the data presented here provides evidence in favor of the Concord-as-Agree hypothesis and against the Concord-as-Percolation hypothesis. Sections 5 and 6 present the analysis with particular focus on how the default forms emerge. Section 7 presents the conclusions.

methodology for the study of code-switching, see (González-Vilbazo 2005; González-Vilbazo et al. 2012; Gullberg et al. 2009; MacSwan 1999)).

2. Code Switching: Evidence That K Is Involved in Concord

2.1. Spanish/Basque Code-Switching

In Basque, case and number morphology are bundled in a portmanteau suffix that attaches to the last constituent in the noun phrase. This is shown in Example (7), where the case+number affix is attached to the adjective with no concord reflex on the noun:

- (7) Basque
- | | | |
|----|-------|-------------|
| a. | gizon | handi-a.Ø |
| | man | big-DET.ABS |
| b. | gizon | handi-ak |
| | man | big-PL.ABS |

Officially, Basque has no grammatical gender and consequently no gender concord. However, contemporary colloquial Basque has allowed some instances of gender concord to creep in. The following is an example (this example is transcribed with the Biscayan Basque morphology preferred by my consultants rather than the standard Batua Euskera; all other examples in the article are spelled out following the conventions of Batua Euskera):

- (8) Basque
- | | | |
|----|-------|--------------------|
| a. | mutil | guap-o-a. |
| | boy | good looking-M-DEF |
| b. | neska | guap-i-e. |
| | girl | good looking-F-DEF |
| | | (name withheld) |

Gender concord has not generalized over the language. It affects a small subset of adjectives (some of them loans from Spanish) and not all speakers accept it. However, it must be kept in mind because it is part of the Basque competence of my language consultants (see (Hualde and Urbina 2003) for a thorough description of Basque morphology and a discussion of gender concord in this language, as well as Badiola and Sande 2018, Parafita-Couto et al. 2015 for recent investigations of gender concord in Basque/Spanish code-switching). On the other hand, number concord is never accepted by Basque speakers.

Spanish is a language with robust gender and number concord on adjectives, quantifiers and determiners. Some Spanish examples are in Example (9):³

- (9) Spanish
- | | | |
|----|--------------|------------|
| a. | maestr-o | ancian-o |
| | teacher-M | old-M |
| b. | maestr-a | ancian-a. |
| | teacher-F | old-F |
| c. | maestr-o-s | ancian-o-s |
| | teacher-M-PL | old-M-PL |
| d. | maestr-a-s | ancian-a-s |
| | teacher-F-PL | old-F-PL |

The plural morpheme in Spanish is [s]. Regarding gender, [o] always signals masculine and [a] feminine with determiners, quantifiers and adjectives. For nouns this correlation has some exceptions: A few words that end in [o] are feminine and a more numerous group of words that end in [a] are masculine. There are also nouns that end in [e] or a consonant and these can go either way. Many nouns

³ I gloss the Spanish desinence [o] as masculine, as is traditional in Spanish linguistics, although as will become clear in the discussion, this is not exactly what I assume.

have a fixed gender: *Cama* ‘bed’ is always feminine and *lecho*, which also means ‘bed’, is always masculine. The noun *víctima* ‘victim’ belongs in this category: It is always feminine regardless of the sex of the individual denoted. Some other nouns can be masculine or feminine according to the natural gender of the individual they denote: For instance, *maestr-* ‘teacher’ could be masculine (*maestro*) or feminine (*maestra*).

Let us now discuss the Spanish/Basque code-switching data. The sentences in Example (10) show run-the-mill code-switched sentences that came up during field work and were judged to be acceptable. Of particular interest is Example (10a), which forms a minimal pair with some of the critical examples below. In Example (10a) a Spanish noun phrase is the subject of a Basque predicate. The Spanish noun phrase shows Spanish gender and number concord:

(10) Spanish/Basque

- a. Algun-a-s maestr-a-s ancian-a-s *etorri dira.*
 Some-F-PL teacher-F-PL old-F-PL arrive aux
 ‘Some old female teachers arrived.’
- b. *Jon-ek* *ekarri* *zituen* los libros que le prestaste
 Jon-ERG bring aux the books that CL.DAT loaned
 ‘Jon brought the books that you loaned him.’
- c. Le compró el libro *auzo-ko* *dendaria-ri.*
 CL.DAT bought the book neighborhood-REL shopkeeper-DAT
 ‘She/he bought the book from the neighborhood shop.’

Consider now the examples in Example (11). Recall that the noun *maestr-* (teacher) is a natural gender noun that can be feminine or masculine. In Example (11a), ‘some old teacher’ has an ergative case marker. In this case, *anciano* and *maestro* appear in the “masculine” form. The quantifier *algún* appears without inflection, which is the norm when it modifies masculine singular nouns.⁴ Interestingly, my consultants say that Example (11a) could be used to denote a female. This suggests that the [o] suffix does not denote natural gender masculine but is instead a default suffix. Another interesting feature of Example (11a) is the absence of the Basque determiner [a]. This determiner would normally be obligatory in a regular singular Basque KP. One exception to this generalization is that [a] and a quantifier are mutually exclusive. It looks as if the Spanish quantifier *algún-* can push out the Basque determiner just like a Basque quantifier. This indicates that code-switching has taken place in the boundary between K and D.

In Example (11b), the Basque suffix is the ergative plural suffix and the Spanish noun and adjective remain unchanged. In particular, Example (11b) shows no number agreement. Example (11c) has a question mark in parenthesis to indicate that gender agreement is acceptable for the two speakers that I worked with but, as was reported to me, some other speakers hesitated somewhat; this gender agreement is consistent with the Basque monolingual data in Example (8). Examples (11d–f) show that number agreement on the adjective or the noun is not acceptable. Finally, Examples (11g,h) show that concord in both is unacceptable:⁵

⁴ The quantifier *algún* appears in the examples when my consultants told me they preferred to have it, otherwise it was omitted; generally, the consultants did not like a singular bare noun subject. This has no bearing on my conclusions.

⁵ An anonymous reviewer reports the following sentence found online:

(i) Spanish/Basque

Lendakari-s muert-o-s-ek *joko dute.*
 Lendakari-PL dead-M-PL-PL.ERG play aux.PL
 ‘The *Lendakaris Muertos* are playing.’

Lendakari is the title of the president of the Basque government. *Lendakaris Muertos* is the name of a punk band. This example contrasts with my consultants’ rejection of Cases (11g,h) and challenges my claims that there is no number concord in a Spanish noun phrase if it is selected by a Basque case morpheme. The only account that I can think of is that *Lendakaris*

(11) Spanish/Basque

| | | | | | | |
|--------|------------------------------------------------|------------------------------------------|--------------------------|---------------------|-------------|-----------------------|
| a. | Algún maestr-o Some teacher-M | ancian-o-k old-M-ERG | fabrika-n factory-LOC | bai indeed laugh | barre do | egiten du. aux |
| | 'Some old teacher(m/f) laughs in the factory.' | | | | | |
| b. | Maestr-o teacher-M | ancian-o-ek old-m-pl.erg | fabrika-n factory-LOC | bai indeed laugh | barre do | egiten dute aux.PL |
| | 'Some old teachers(m/f) laugh in the factory.' | | | | | |
| c. (?) | Algun-a maestr-a some-F teacher-F | ancian-a-k old-F-ERG | | | | |
| d. * | maestr-o-s teacher-M-PL | ancian-o-ek old-m-pl.erg | | | | |
| e. * | maestr-a-s teacher-F-PL | ancian-a-ek ⁶ old-f-pl.erg | | | | |
| f. * | maestr-o teacher-M | ancian-o-s-ek old-m-pl-pl.erg | | | | |
| g. * | maestr-o-s teacher-M-PL | ancian-o-s-ek old-m-pl-pl.erg | | | | |
| h. * | maestr-a-s teacher-F-PL | ancian-a-s-ek old-f-pl-pl.erg | | | | |

I propose that the structure of Example (11a) is as in Example (12). The Basque ergative marker [k], head of KP, has selected a Spanish DP.

(12)

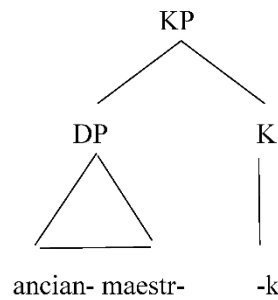

The appearance of the Basque K strips the DP of its concord, in contrast with Example (10a), where the noun phrase has no Basque case and gender and number concord are alive and well.

In the following I discuss some more data to confirm the intuition presented in Example (12). The examples in Example (13) show the same Spanish DP with Basque dative case with the same acceptability judgment: No number agreement, acceptance of gender agreement by some speakers:

Muertos is a proper name and therefore the Spanish suffixes are regarded as part of the root. To compound the puzzle, a search of *lendakaris muertosei* (dative case) or *lendakaris muertosak* (absolutive case) yielded no results.

⁶ As an anonymous reviewer points out, the sequence [ae] is phonotactically unacceptable in Basque, so *ancianaek* is actually pronounced *ancianek*.

(13) Spanish/Basque

| | | | | | | |
|--------|-----------------------------------------|----------------------------------|---------------------|-------------------------|-------------------|-------------|
| a. | Algún maestr-o some teacher-M | ancian-o-ri old-M-DAT | liburua book | bai indeed | gustatzen like | zaio aux |
| | 'Some old teacher(m/f) likes the book.' | | | | | |
| b. | Maestr-o teacher-M | ancian-o-ei old-M-DAT.PL | liburua bai book | guztazen indeed like | zaie. aux.PL | |
| c. (?) | Algún-a maestr-a some-F teacher-F | ancian-a-ri old-F-DAT | | | | |
| d. * | Maestr-o-s teacher-M-PL | ancian-o-ei old-M-DAT.PL | | | | |
| e. * | maestr-a-s teacher-F-PL | ancian-a-ei old-F-DAT.PL | | | | |
| f. * | maestr-o teacher-M | ancian-o-s-ei old-M-PL-PL.DAT | | | | |

Absolutive case in the singular is a null morpheme in Basque and hence less informative. The examples in Example (14) are in absolutive plural, which has the affix [ak]. Once again, plural concord is unacceptable, as shown in Examples (14b–d):

(14) Spanish/Basque

| | | | |
|------|----------------------------|-------------------------------|-----------------------------|
| a. | Maestr-o teacher-M | anciano-ak old-PL.ABS | etorri dira. come aux.PL |
| | 'old teachers arrived' | | |
| b. * | Maestr-o-s teacher-M-PL | ancian-o-ak old-M-PL.ABS | etorri dira. come aux.PL |
| c. * | Maestr-o-s teacher-M-PL | ancian-o-s-ak old-M-PL.ABS | etorri dira. come aux.PL |
| d. * | Maestr-a-s teacher-F-PL | ancian-a-s-ak old-F-PL.ABS | etorri dira. come aux.PL |

For completeness, I now discuss two nouns with fixed gender. The words I have chosen are *cama* 'bed' which is feminine in gender and has the [a] suffix and *lecho* 'bed', masculine and inflected with [o]. These two nouns do not exhaust the range of empirical puzzles presented by the grammar of Spanish gender, which has a number of irregularities (see (Roca 1989; Harris 1991) for a detailed discussion) but such a discussion would take us too far afield. Instead, these two examples will serve as representatives of the range of possibilities that one can have and, hopefully, will give us more confidence that the approach followed here is correct.

I start with the simplest example, a masculine noun. Consider the examples in Example (15). They all involve the noun *lecho* 'bed'. The contrast between Examples (15a,b) and Examples (15c,d) shows, once again, that number concord is not possible within the noun phrase when the case marker is Basque.

(15) Spanish/Basque

- a. Algún lech-o esplendid-o-ri izara berriak ipini dizkiot
 some bed-M splendid-M-DAT sheet new put aux
 ‘I put a new sheet on some splendid bed.’
- b. Lech-o esplendid-o-ei izara berriak
 bed-M splendid-M-DAT.PL ipini dizkiet.
 sheet new put
 aux.PL
 ‘I put a new sheet on the splendid beds.’
- c. * lech-o-s esplendid-o-ei
 bed-m-pl splendid-M-DAT.PL
- d. * lech-o-s esplendid-o-s-ei
 bed-m-pl splendid-M-PL-DAT.PL

Our analysis of *cama* ‘bed’ confirms the previous analysis. This is shown in the following examples:

(16) Spanish/Basque

- a. Alguna cam-a esplendid-a-ri izara berriak ipini dizkiot.
 some-F bed-F splendid-F-DAT sheet new put aux
 ‘I put a new sheet on some splendid bed.’
- b. ? Algun cam-a esplendid-o-ri izara berriak ipini dizkiot.
 some bed-F splendid-M-DAT sheet new put aux
 ‘I put a new sheet on some splendid bed.’
- c. Cam-a esplendid-a-ei izara berriak ipini dizkiet.
 bed-F splendid-F-DAT.PL sheet new put aux.PL
 ‘I put a new sheet on the splendid beds.’
- d. * cam-a-s esplendid-a-ei
 bed-F-PL splendid-F-DAT.PL
- e. * cam-a-s esplendid-a-s-ei
 bed-f-pl splendid-f-pl-dat.pl

Let us start by comparing Example (16a) and Example (16b). We see that my consultants prefer gender agreement to no agreement, although lack of gender agreement is not entirely ruled out. The judgments in Examples (16c–e) show, once again, that plural concord is sharply disallowed.

To conclude this section: The main puzzle that needs an account is the disappearance of number and (for some speakers) gender concord when the Spanish noun phrase is the complement of a Basque case marker. Additionally, we would like to understand the possibility of using [o] as a default form for natural gender nouns, as in Example (11).

2.2. Russian/Kazakh Code-Switching

Russian is a language with rich gender, number and case concord. This can be seen in the following examples (see also Example (1a)):

(17) Russian

- Vyssh-aya shkol-a
 high-F.SG.NOM school-F.SG.NOM/ACC
 ‘high school’

(18) Russian

- Etu star-uyu ploshod'-Ø
 this.F.SG.ACC old-F.SG.ACC square(f.sg)-ACC/NOM
 ‘this old square’

Kazakh, on the other hand, has no gender or any form of concord inside the noun phrase (Muhamedova 2016, p. 66). It does have a plural affix [lar] that attaches to the noun and precedes the case marker:

(19) Kazakh

qızıl alma-lar
red apple-PL

(Muhamedova 2016, p. 66)

We move now on to code-switching contexts. Consider now Examples (20) and (21). In these examples, a Russian singular noun phrase is attached to a Kazakh case morpheme. The adjectives adopt a nominative, masculine, singular form without gender concord. Following Auer and Muhamedova, I take this adjectival inflection to be default. The noun itself appears devoid of any inflection whatsoever:

(20) Russian/Kazakh

Vyssh-ij shkol-di bitir-d osında.
high-M.SG.NOM/ACC school-ACC finish-3.PAST here
'He finished high school here.'

(Auer and Muhamedova 2005, p. 43)

(21) Russian/Kazakh

Uzhe anau star-ij ploshchod-ti ne-ler-di zönde-di
already this old-M.SG.NOM/ACC square-ACC thing-PL-ACC renovate-3SG
'There the old square and so were already renovated.'

(Auer and Muhamedova 2005, p. 43)

Example (22) shows that there is no number concord in the Russian adjective when the noun phrase is plural and the complement of a Kazakh case marker. The noun *knizh* 'book' bears a default adjective affix that is homophonous with masculine or accusative singular. However, the noun *vismavk* in this example appears with some inflection—in contrast with the nouns in Examples (20) and (21), which are bare. The morpheme [a] that suffixes *vismavk* bundles together feminine gender with nominative and singular features. In other words, this suffix has default features for case and number, but it has the gender normally expected of *vismavk*. This is followed by the Kazakh plural affix [lar]:

(22) Russian/Kazakh

Knizh-n-ij vismavk-a-lar tema-lar-ï-n
book-buffer-M.SG.NOM/ACC exhibition-F.SG.NOM/ACC-PL topic-PL-POS3-ACC
'the topics of the book exhibitions'

(Auer and Muhamedova 2005, p. 43)

Once again, there is no concord between the adjective and the noun. However, the feminine inflection in Example (22), in contrast with Example (21), is intriguing.

As (Auer and Muhamedova 2005) point out, the loss of concord appears in a specific code-switching context—when the noun phrase is a complement of a Kazakh case. Concord errors occur rarely (less than 7%) when these bilinguals speak Russian monolingually. In other words, concord is a regular ingredient of their Russian grammar, it only disappears systematically in code-switching:

(23)

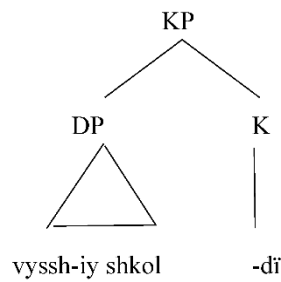

Thus, in Spanish/Basque code-switching we saw that adjectives and nouns always show up with some morphology: Default for adjectives, default for natural gender nouns and the normal desinence for other nouns. In Kazakh/Russian code-switching we see that adjectives always exhibit default morphology, nouns have no desinence in the singular but they have a suffix that inflects for gender although it has default case and number. We have some puzzles in need of an account.

2.3. German/Turkish Code-Switching

German has a robust system of concord. Adjectives and determiners in the noun phrase inflect for case, number and gender. The noun inflects for number. The following is an example:

(24) German

Sein-en neu-est-en Film habe ich nicht gesehen.
 his-M.ACC new-SUPERL-M.ACC film(m) have I not seen
 'I have not seen his latest film.'

Descriptive grammars distinguish between a weak inflection and a strong inflection for adjectives. The weak inflection is highly syncretic and consists of the desinence [-e] or [-en]. The pattern is somewhat complicated but nonetheless it is fair to assume that [en] is rule-governed and [e] is the default form (*pace* (Zwicky 1985)). More details on weak inflection will be presented in Section 6. The strong inflection has six possible suffixes and carries more information for number, gender and case.⁷ The strong inflection surfaces on the definite determiner and demonstrative, otherwise it shows up on the adjectives.

Consider now the examples in Example (25). In Example (25a) the form [er] is the strong form for nominative masculine singular concord. The strong suffix [er] shows up on the determiner and the adjective is left with weak inflection. In Example (25b) the strong inflection suffixes the adjective and the indefinite determiner appears uninflected (see (Harbert 2007; Roehrs 2015) for extensive discussion of German(ic) inflection):

⁷ Strong forms and weak forms of concord inflection in German. Notice that masculine accusative is [-en] in both cases:

| | MASC | NEUT | FEM | PL |
|-----|------------|-----------|-----|-----|
| NOM | -er | -es | -e | -e |
| ACC | -en | -es | -e | -e |
| DAT | -em | -em | -er | -en |
| GEN | (-es)/-en | (-es)/-en | -er | -er |

| | MASC | NEUT | FEM | PL |
|-----|------|------|-----|-----|
| NOM | -e | -e | -e | -en |
| ACC | -en | -e | -e | -en |
| DAT | -en | -en | -en | -en |
| GEN | -en | -en | -en | -en |

(25) German

- | | | | |
|----|------------------|--------------|-----------|
| a. | d-er | neu-e | Film |
| | DEF-NOM.SG.M | new-INFL | film.M.SG |
| | 'the new movie' | | |
| b. | ein | neu-er | Film |
| | INDEF.NOM.SG.M/N | new-NOM.SG.M | film.M.SG |
| | 'a new movie' | | |

For our discussion, it is important to note that in masculine, singular, accusative the suffix [-en] can be used in strong or weak contexts:

(26) German

- | | | | |
|----|-----------------|----------|-----------|
| a. | d-en | neu-en | Film |
| | DEF-ACC.SG.M | new-INFL | film.M.SG |
| | 'the new movie' | | |
| b. | ein-en | neu-en | Film |
| | INDEF.ACC.SG.M | new-INFL | film.M.SG |
| | 'a new movie' | | |

German nouns carry valued gender although it is not spelled out in any particular manner.⁸ German nouns only spell out case for dative plural and masculine and neuter genitive. German nouns do spell out plural, as I show in a minute.

There is no concord in Turkish. In the following example, the plural suffix is attached to the noun and there is no reflex of this suffix on the adjective or quantifier.

(27) Turkish

- | | | |
|---------------------|------|-----------|
| bütün | eski | kitap-lar |
| all | old | book-PL |
| 'All the old books' | | |

(Göksel and Kerslake 2005, p. 145)

Code-switching is a regular feature of the speech of German/Turkish bilinguals living in Germany. The following are some corpus data. Notice how material from the two lexicons is tightly integrated and that a Turkish affix can attach to a German root yielding the form *traurigim* 'I am sad':

(28) Turkish/German

- | | | | | | | |
|----|------------------------------------------------|--------|-----------------|---------------|-------------------|---------|
| a. | Ben | seyi | <i>komisch</i> | <i>finden</i> | ettim | |
| | I | thing | funny | find | have.1 | |
| | 'I find this thing funny.' | | | | | |
| b. | <i>Menschen</i> | beni | <i>verrückt</i> | <i>çok</i> | <i>traurig-im</i> | hacı ya |
| | people | me.DAT | crazy | very | sad-be.1 | boy oh! |
| | 'People make me crazy, I am very sad, oh boy.' | | | | | |

(Cetinoglu 2017, p. 4217)

Consider now Examples (29) and (30). In Example (29), the Turkish light verb *yapıyor* 'doing' has selected a VP consisting entirely of German constituents; notice that the structure of the object is unremarkable as a German KP.

⁸ German teachers often say that the suffix [e] is a feminine marker but there are many feminine nouns that do not have this suffix as well as nouns that have the suffix and are not feminine.

(29) German/Turkish

| | | | | | |
|----|----------------------|--------------|-------|-------|-----------------|
| a. | ein-en | neu-en | Film | sehen | <i>yapıyor</i> |
| | INDEF-ACC.SG.M | new-ACC.SG.M | film | see | do.PROG |
| | 'seeing a new film' | | | | |
| b. | ein | neu-es | Haus | sehen | <i>yapıyor.</i> |
| | INDEF | new-ACC.SG.N | house | see | do.PROG |
| | 'seeing a new house' | | | | |

Example (29) contrasts with Example (30) because in Example (30) the direct object has been affixed a Turkish case marker. As reported by the bilingual German/Turkish consultants, when the German noun phrase appears with a Turkish case affix [i]/[u], concord disappears, and the noun phrase constituents appear in a default form. In particular, Examples (30b,d), with a fully inflected German adjective, are judged unacceptable:

(30) German/Turkish

| | | | | |
|------|------------------------|----------------|-------|----------------|
| a. | neu-e | Film- <i>i</i> | sehen | <i>yapıyor</i> |
| | new | film(m)-ACC | see | do.prog |
| | 'seeing (a) new film' | | | |
| b. * | neu-en | Film- <i>i</i> | sehen | <i>yapıyor</i> |
| | new | film(m)-ACC | see | do.prog |
| c. | neu-e | Haus- <i>u</i> | sehen | <i>yapıyor</i> |
| | new | house(n)-ACC | see | do.prog |
| | 'seeing (a) new house' | | | |
| d. * | neu-es | Haus- <i>u</i> | sehen | <i>yapıyor</i> |
| | new | house(n)-ACC | see | do.prog |

In the acceptable examples, the adjective shows up with the [e] desinence, regardless of the gender of the noun. Interestingly, this desinence is neither the weak nor the strong form of the adjective in concord with a masculine accusative noun. As mentioned, the weak and strong form for masculine accusative singular is [en]. In Example (30b) we can see that the [en] form is out. Thus, what we see here is that there is really a minimal inflection, only a default form devoid of features.⁹

We have seen that gender inflection disappears from the adjective when the noun exhibits a Turkish case marker. Let us see now what happens with plural inflection. In Turkish, plural is expressed with the exponent [lar] (or [ler], depending on vowel harmony) as seen in Example (27). [lar] is most certainly the head of Num—one piece of evidence in this direction is that [lar] disappears with numerals (Göksel and Kerslake 2005; Hicks 2018), which suggests that they occupy the same syntactic position. The German noun does not inflect for gender or case, but it does inflect for number. The exponence of plural on German nouns is a notorious jungle: Plural can be spelled out as [s], [en], [er], [e], or Ø, the latter three with or without umlaut in the root:

⁹ The reader may have noticed that the German definite determiner has also disappeared from the examples in Example (30). It looks like code-switching between K and the rest of the noun phrase may affect features other than concord. I postpone a deeper investigation of this matter for future research.

(31) German

| | Singular | Plural |
|----|-----------------|---------------|
| a. | Job job | Job-s |
| b. | Frau woman | Frau-en |
| c. | Kind child | Kind-er |
| d. | Mann man | Männ-er |
| e. | Schuh shoe | Schuh-e |
| f. | Zahn tooth | Zähn-e |
| g. | Dichter poet | Dichter |
| h. | Mantel coat | Mäntel |

It seems that we have several possible analyses for the plural suffix: (i) It could be the spell out of a concord node on *n*; (ii) it could be the spell-out of the head Num; or (iii) we could take the different forms of plural to be the output of as many readjustment rules. Option (iii) meshes well with the irregularity of the system. Under this view, we could posit a rule such that a root that we can list in List 1 as $\sqrt{\text{CHILD}}$ spells out as [kinder] when selected by [Num:plural]. The code-switching data may be helpful to help us decide among the three options. Compare the examples in Examples (32a–c):

(32) German/Turkish

| | | | | | | |
|----|----|----------------|----------|-----------------------|-------|----------------|
| a | * | Buch- <i>u</i> | neu-e | Kind-er- <i>e</i> | geben | <i>yaptım.</i> |
| | | book-ACC | new-INFL | child-PL-DAT | give | do.PERF.1 |
| b. | ?? | Buch- <i>u</i> | neu-e | Kind-ler- <i>e</i> | geben | <i>yaptım.</i> |
| | | book-ACC | new-INFL | child-PL-DAT | give | do.PERF.1 |
| c. | | Buch- <i>u</i> | neu-e | Kind-er-ler- <i>e</i> | geben | <i>yaptım.</i> |
| | | book-ACC | new-INFL | child-PL-PL-DAT | give | do.PERF.1 |

'I gave the book to the new children.'

My consultants rejected Example (32a) with German plural and Turkish case. However, they also hesitated to accept Example (32b), with Turkish plural and case. The only one they accepted without difficulty was Example (32c), with both German and Turkish plural suffixes.

This duplication of the functional morpheme is only mildly surprising for the student of code-switching. Duplication is found occasionally in the corpus data and acceptability judgments confirm that it is indeed possible. Consider the noun *madays* 'days' in Example (33). The Shona prefix *ma* denotes the Bantu class 6, which is a plural class. The English noun also carries the English plural suffix *s*. In example (34), there are two complementizers, the Spanish one *que* and the Basque one *-ela*:

(33) Shona/English

| | | | | |
|---------------------|---------|---------|------------|-----------------|
| <i>But ma-day-s</i> | a-no | a-ya | ha-ndi-si | ku-mu-on-a. |
| but CL6-day-PL | cl6-dem | cl6-dem | neg-1s-cop | inf-3s/o-see-fv |

'But these days I don't see him much anymore.'

(Myers-Scotton 1997, p. 111)

(34) Spanish/Basque

| | | | | |
|---------|-----|-----|--------|-------|
| Creo | que | Jon | etorri | d-ela |
| Think.1 | C | Jon | come | aux-C |

'I think that Jon has come.'

(Vergara 2018, p. 234)

There is no general analysis of duplication in code-switching that I am aware of, but see (Vergara 2018) as well as (Goldrick et al. 2016) for some intriguing ideas.

The reduplication of the plural morpheme in Example (32c) can be understood if we take the plural suffix [er] of the German word to be the result of a readjustment rule. When the root $\sqrt{\text{CHILD}}$ is selected by [Num:plural], $\sqrt{\text{CHILD}}$ is spelled out as [kinder] while [Num:plural] spells out as [ler]. As an alternative hypothesis, one could take the suffix [er] of *kinder* to be an exponence of concord. Under this analysis, the acceptability of Example (32c) would constitute a counterexample to my hypothesis that the presence of Turkish K inhibits concord within the German DP. However, notice that the adjective appears again in the default form, just as in the examples of Example (30), which indicates that concord has indeed been inhibited also in this example. I conclude that the plural suffix in *kinder* 'children' is the output of a readjustment rule and not an exponence of concord.¹⁰

Let us return to our main point. The contrast between the examples in Examples (29) and (30) as well as the absence of number concord in Example (32) show that the presence or absence of case morphology is crucial for the presence of concord. Concord in the German adjective disappears when the noun phrase is suffixed a Turkish case suffix. The acceptability judgments of Turkish/German bilinguals parallel those of Basque/Spanish speakers as well as the corpus data provided by (Auer and Muhamedova 2005) and provide further evidence that K is deeply involved in concord.

(35)

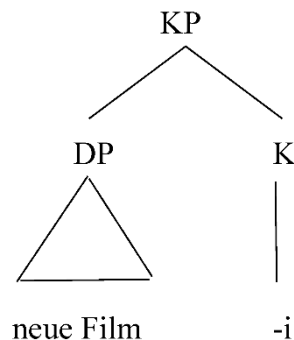

As I finish this section, I will like to highlight the uncanny parallelism of the data in three distinct language pairs. This parallelism gives me confidence to make two claims: (i) The data are indeed real and the judgments cannot be chance and (ii) the role of K in concord obeys some principled reason.

3. Where Is the Switch Boundary?

A reader of this paper suggests approaching the data just presented from a different angle. The previous discussion assumes that there is code-switching between K and DP. This entails that K is drawn from one of the non-concord languages and the selected complement is drawn from concord

¹⁰ An anonymous reviewer suggests that the German and Turkish plural morphemes may spell out different terminals and mentions the investigations of (Wiltschko 2008; Hicks 2018) to explore this hypothesis. Adapting the findings of this scholars, one could conclude that the Turkish plural morpheme is the spell out of [Num:plural] while the German one would be an adjunct modifier like the one found in Halkomelem. However, German Number has none of the properties of Halkomelen Number, as discussed in the above-mentioned work, which leads me to not adopt this hypothesis here.

languages. To be more precise, both the syntactic terminal and the vocabulary item inserted in the terminal are drawn from a concord language within the DP.

The reader suggests a second possibility. Quite plausibly, the syntactic terminals within the DP also belong to the non-concord language. At the point of vocabulary insertion, both an exponent from the non-concord language and an exponent from the concord language could be inserted and, since there is no reason to forbid it, what is inserted is the exponent from the concord language. This hypothesis is exemplified in Example (36). In Example (36) a Turkish K selects for a Turkish noun phrase. Within the noun phrase there is an adjective phrase, which consists of the root $\sqrt{\text{NEW}}$ and the categorizing head *a* forming the syntactic structure [ap a [$\sqrt{\text{NEW}}$]]. Crucially, *a* has been drawn from the Turkish vocabulary. The vocabulary insertion rules have two possible exponents for root $\sqrt{\text{NEW}}$, the German *neu* and the Turkish *yani* (both *neu* and *yani* mean ‘new’). In the examples above, my consultants would simply have chosen *neu*. Moreover, since the *a* is Turkish, there cannot be any concord:

(36)

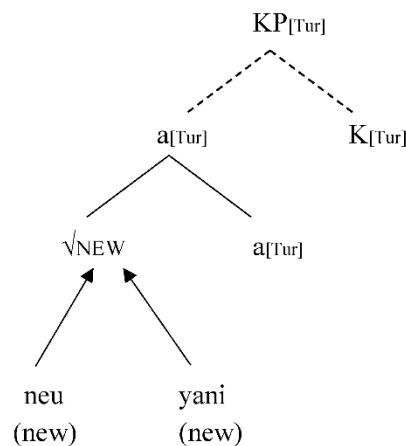

The scenario suggested by the reviewer is possible, at least partially. Code-switching does not have to take place at the K-DP boundary but may take place at many other junctures. Consequently, it is certainly possible that constituents from the DP also belong to the non-concord language. We have seen some examples in which the language of K and the plural morpheme seem to come from the same non-concord language (Turkish and Kazakh)—we will go back to these in Section 6. However, this alternative analysis leaves unaccounted for the appearance of the default form when concord fails: If *a* were Turkish, as suggested in Example (36), we would expect to find an adjective with no inflection whatsoever, not a default inflection: We should find *neu Filmi* not *neue Filmi* (note that in predicate position, German adjectives show no inflection, which entails that the *neu* option is fully grammatical from a morphological point of view).

The structure of the attributive adjective in Turkish and German is different. The German attributive adjective inflects for gender, number and case, while the Turkish one never does. Within the current framework, I take it that the German *a* selects an extra node with unvalued gender, number and case features (in fact, quite possibly an independent node for each feature that ends up fused into one node). The Turkish *a* does not select this extra node. This is represented in Example (37):

(37)

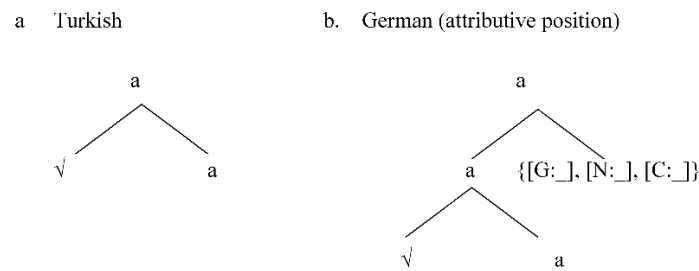

The appearance of default morphology is linked to the presence of this extra node for ϕ -features. The structure in Example (37a) has no room for any inflection. Thus, the appearance of the [e] suffix in the Turkish/English code-switching examples can be accounted for only if the *a* that we have in the structure is a German *a*.

Likewise, with some caveats, we could expect that the Russian and Spanish adjectives could appear without any inflection at all, rather than the default inflection that they get. That is, Spanish and Russian have an adjectival structure similar to Example (37b), with an extra node (or nodes) for the concord features while Basque and Kazakh’s adjectival structure is as in Example (37a) (modulo the possibility of some gender concord among some Basque speakers). The appearance of inflection in the code-switching examples suggests that the structure of *a* must be as in Example (37b). While we do not see uninflected adjectives in the monolingual Russian and Spanish grammars, nothing phonotactically prevents forms like **ancian* or **vissh* from showing up.

I conclude that (except where otherwise indicated) what we see in the data in Section 2 is indeed true code-switching and the syntactic terminals selected by K come from the concord language.

4. Unsuccessful Alternative Paths

Let us then take it for granted that what we have seen in the examples in Example (2) constitutes code-switching between K and DP (with the exceptions noted) with the result that concord within the DP disappears. Interestingly, these data present empirical evidence against two current approaches to concord. I examine them in this section.

4.1. Concord as Percolation or as an Instance of Agree

(Norris 2014) has taken to task the Concord-as-Agree hypothesis and proposes what I call Concord-as-Percolation. His argument is that there are so many differences between agree and concord that the assumption that they are instances of the same operation is unwarranted (but see (Baker 2008) for arguments that agree and concord are not that different). (Norris 2014) proposes a feature percolation mechanism that allows the gender and number features to move up the noun phrase tree (for technical presentation of the mechanism see (Norris 2014, 135ss). In particular, the feature percolation mechanism allows for the following scenario: If XP has feature *x* and is the complement of Y and Y has no feature *x* then feature *x* may percolate from XP to YP:

(38)

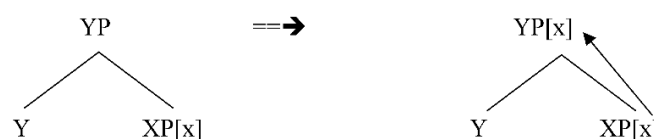

The feature percolation mechanism allows for the gender feature on *n* to percolate up to NumP and to DP. Likewise, the same mechanism allows for the number feature of NumP to percolate up to DP:

(39)

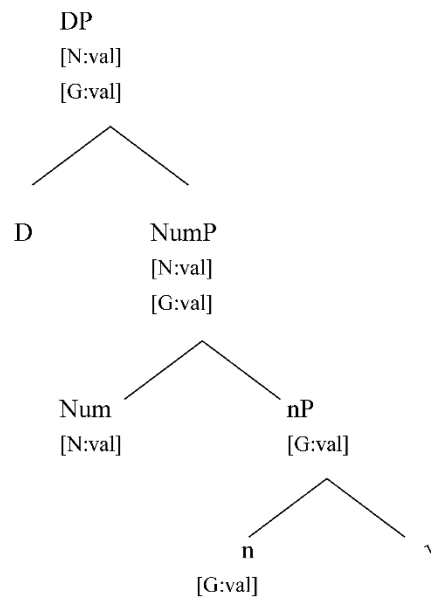

Case, on the other hand, must percolate *down* from the highest head in the noun phrase to the lowest one where it is expressed.

I believe the data presented in Section 2 provide evidence that gender and number concord within the noun phrase is not the result of feature percolation from *n* up. Feature percolation leaves our data unexplained because it provides no reason why an alteration in case morphology should affect feature percolation in any way. For instance, in Examples (20) and (21), feminine gender is a property of the Russian noun *shkol* and it should easily percolate up the tree and trigger gender concord on the Russian adjective *vyssh*.

(40)

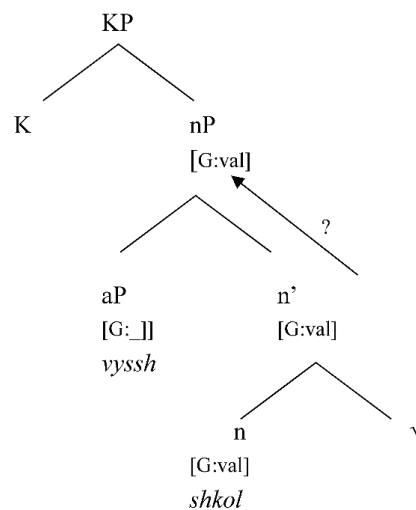

However, concord between the Russian noun and adjective cannot take place if K is Kazakh. This cannot be accounted for within a percolation system. On the other hand, the data presented in Section 2 can be taken to support the Concord-as-Agree approach with K as the originator of the concord operation.

4.2. What Can Be a Probe?

A noun phrase may have a number of heads with unvalued features. In Spanish, determiners, quantifiers and adjectives inflect for gender and number, in German they also express case. One could then assume that each of these unvalued features constitutes an independent probe, as proposed in (Baker 2008) and recently developed in (Puškar 2018). Example (41) represents concord under the assumption that every unvalued feature can probe. It shows that the determiner probes to value its unvalued gender and number while K does the same. There is no adjective in Example (41) but, if we had one, it would also have independent probes for gender and number:

(41)

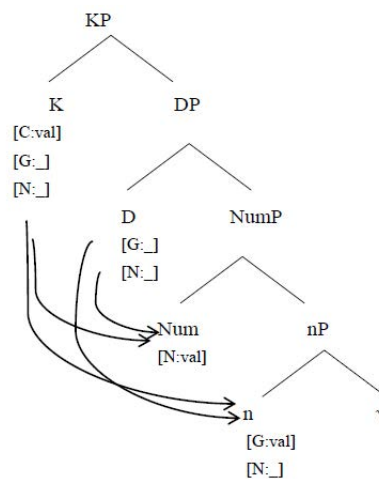

The evidence presented in Section 2 militates against this proposal. In effect, if every terminal in the noun phrase is an independent probe, the features of K should be irrelevant for the lower terminals. The fact that concord is only possible with the right type of K suggests that K regulates concord in the noun phrase and the lower unvalued features do not trigger agree.

4.3. Conclusions

Thus, from this point onwards I assume that concord in the noun phrase is a top-down operation and not a bottom-up percolation of features. I also take it that agree is ruled by K and no other head within the noun phrase can probe.

5. Analysis 1: Concord as Agree

I assume that concord is a form of agree, as defined in (Chomsky 2000), (see (Carstens 2001; Landau 2016; Norris 2012; Toorsarvandani and Urk 2013)). I also assume that the probes are phase heads, and vice-versa, unless the features of the phase head are inherited by its complement (Chomsky 2000, 2008). Finally, I propose that K is a phase head. The corollary of the previous hypotheses is that K is the probe that triggers concord in the noun phrase.¹¹

Example (42) presents a model of what concord looks like in a language with gender and number concord.¹² K comes into the derivation with unvalued gender and number, as well as an unvalued case feature. The determiner also comes into the derivation with unvalued gender and number. The valued

¹¹ I believe the incorporation of K into the thinking about concord is a contribution of (Norris 2012). Earlier approaches to Concord-as-Agree take D to be the starting point, ignoring K (Carstens 2001; Danon 2011; Kramer 2015; Toorsarvandani and Urk 2013). As the Russian example in Example (1a) shows, case inflects for gender and number in some languages and therefore it should be included in the concord mechanism.

¹² What is presented in Example (42) is an abstract model, individual languages depart from it in specific ways, as I shall show.

number feature heads its own projection. Finally, the little *n* has a valued gender feature as well as an unvalued number feature. Here the different features are all in a bundle but in Section 6 I look at the fine structure of these heads:

(42)

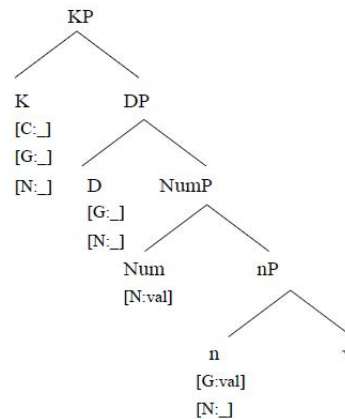

At this point, we have to take a decision. K values its [C:_] with an external case assigner while [G:_] and [N:_] are valued within the DP. The logic of the phase system tells us that the gender and number features are valued first, possibly even before KP merges with the main clause spine.¹³ In fact, we will see that the valuation of gender in Spanish provides empirical evidence that this is in fact the case.

Thus, K probes its c-command domain. K finds valued number and gender features but also additional occurrences of [N:_] and [G:_]. The goal now is to make sure that all the unvalued features, including the unvalued features on D and *n*, are valued as a result of probing by K. This can be accomplished by incorporating the co-valuation mechanism of (López 2007). It consists of two assumptions. The first assumption is *Full Sharing*: feature sharing between probe and goal is maximal if possible (for discussion of Feature Sharing see Frampton and Gutmann 2006, Haug and Nikitina 2016). Full Sharing affects two occurrences of an unvalued feature that happen to be in a probe-goal dependency. As a consequence of Full Sharing, two unvalued features of the same type involved in a probe form a dependency: The two features are not allowed to vary independently; they are co-valued. I use a numerical sub-index to express a dependency of co-valued features. In Example (43), K probes and encounters the unvalued features of D. As a result of the probe, they form a dependency:

(43)

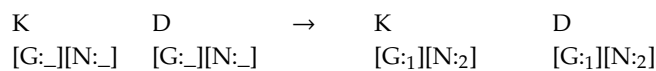

As the probe proceeds and finds a valued token of the same feature type, every occurrence of the feature is valued simultaneously. In Example (44) the probe encounters Num and the features of both K and D are valued.

(44)

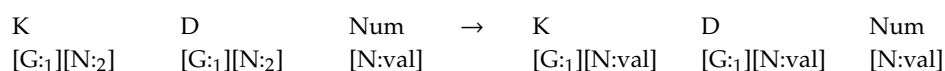

Then the probe reaches *n*. *n* values the gender features of D and K. At the same time, the number of *n* is valued with the number of the probe.

¹³ I would like to thank an anonymous reviewer for *Languages* for pointing out the importance of the order of operations.

(45)

K D n → K D n
 [G:1][N:val] [G:1][N:val] [G:val][N:] [G:val][N:val] [G:val][N:val] [G:val][N:val]

Once all this KP-internal operations have taken place, KP can merge with the clausal spine and eventually [C:_] is valued.

Let me now introduce adjectives. I take it that adjectives consist of a categoriless root and a functional head *a* that categorizes it. The head *a* in concord languages is a complex head with unvalued features. I take it that adjectives are adjuncts to nP, although nothing hinges on this choice (see (Cinque 2010) among many others that propose more complex theories of attributive adjectives). This set of assumptions is shown in Example (46).

(46)

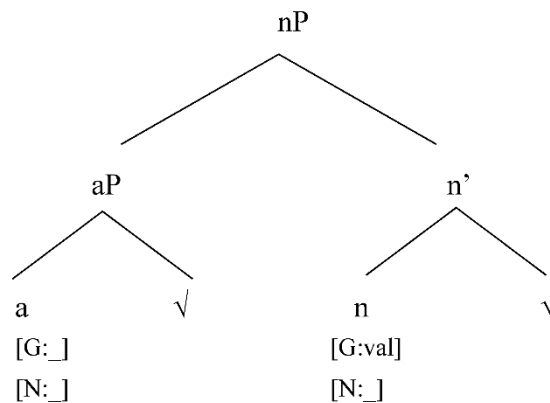

I take it that the unvalued features of the adjective are co-valued with those of K as the latter probes and eventually valued.

Let us now return to code-switching. In the data discussed in Section 2 we saw that a case marker from a language without concord deactivates the concord system in a language that would normally have concord, with the result that every inflection morpheme appears in a default form. In our terms, this is analyzed as follows. K from a non-concord language has no unvalued features and therefore it is not a probe. Since there is no probing, the unvalued concord features of the noun phrase are never valued. They remain unvalued to PF:

(47)

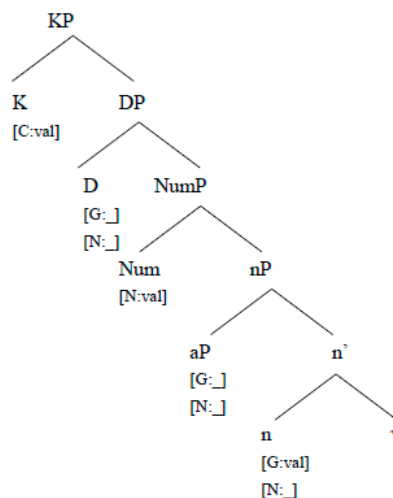

The work of (López 2007; Preminger 2014) has argued that Agree may fail; unvalued features can survive and do not lead to a crashed derivation. I take this claim to be empirically well supported.

As far as I know, a detailed analysis of the vicissitudes of unvalued features has not been proposed. In the following section I discuss the mechanism that provides default vocabulary items with unvalued features.

6. Analysis 2: Default Morphology

6.1. The Emergence of Default

In order to study the emergence of default morphology, I adopt the Distributed Morphology framework (Halle and Marantz 1993; Harris 1994; Embick 2015). As mentioned in the introduction, syntax manipulates abstract features and bundles of features. Vocabulary Insertion Rules (VIRs) spell out the proper exponents—vocabulary items—for the syntactic terminals, en route to PF.

Vocabulary Insertion obeys (Halle 1997) *Subset Principle*, which states that the vocabulary item with the closest feature bundle gets inserted as long as the features of the vocabulary item are a subset of the features of the syntactic terminal. In Example (48), terminal T has the feature set {x,y}, vocabulary item I has the feature {x} and vocabulary item J has the feature set {x,y,z}. In this situation, I is inserted in T:

(48)

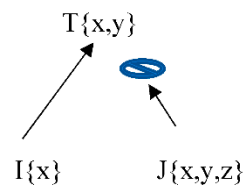

Before VIRs apply, some operations may apply to syntactic terminals. Fusion is of particular importance in the following (see (Halle and Marantz 1993) for the classic reference on fusion). Fusion is the most natural mechanism to generate syntactic terminals with portmanteau morphemes. For instance, take the nominal inflection of a language that has features for gender, number and case bundled up in one exponent. I suggest that these features head their own terminals and are fused into one before VIRs apply.

In Example (49), the complex word X_{max} has three adjoined terminals consisting of the features a, b and c. The operation of fusion allows them to unify in one terminal with the features {a,b,c}, which can then find an appropriate exponent:

(49)

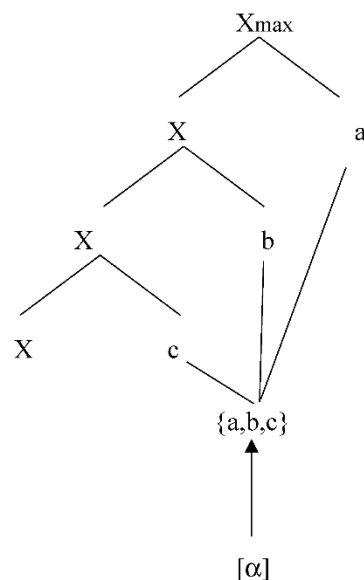

The only restriction on fusion that I incorporate into my analysis is that the features must be compatible. Feature compatibility is understood in the most basic way: If two terminals a and b have features of the same type but different value, fusion is not possible. Terminals with incompatible features cannot be fused because the resulting terminal would find no exponent. Fusion will become prominent in my analysis of German/Turkish and Russian/Kazakh code-switching.

In the earlier minimalist models, valuation of features in syntax was considered a condition of well-formedness. After the work of (López 2007; Preminger 2014) it is understood that a feature may remain unvalued into PF. Within a Distributed Morphology framework, the question that arises is what vocabulary item fits a terminal with unvalued features. The logic of the system suggests that it should be a default form. I define default as follows: Given a set of rules that spell out a certain terminal x, the default rule is the one that spells out x regardless of any other features associated with x (see (Kiparski 1973) *Elsewhere Rule*, see also (Brown 2016) thoughtful discussion of defaults). A default is a common denominator of a set of exponents. In Example (50), the exponent [γ] is default because it spells out any terminal T that has feature x:

(50)

| | | |
|----------|----|-----|
| Tx{y, z} | ←→ | [α] |
| Tx({y} | ←→ | [β] |
| Tx | ←→ | [γ] |

I suggest that features that remain unvalued at the point of vocabulary insertion find an exponent thanks to the default rule. That is, the List 2 of vocabulary items may include an exponent with a minimal feature structure, specifying only the feature type [F]. Such an exponent can be inserted in any terminal that has F, including any value of [F] and also an unvalued [F: _]. As shown in Example (51), an exponent that is defined as fitting any terminal of feature [F] can be inserted in a terminal that has an unvalued [F: _]

(51)

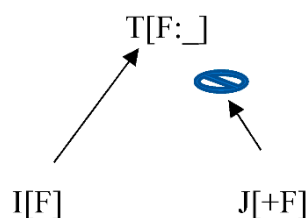

This assumption is crucial for all the subsequent analyses.¹⁴

6.2. Spanish/Basque

I begin with Spanish/Basque code-switching. Recall the empirical facts we need to account for: (i) Lack of number inflection on adjectives and other DP constituents (and, for some speakers, also gender); (ii) the appearance of a default suffix on adjectives and natural gender nouns (*maestr-* ‘teacher’), while fixed gender nouns (*cama* ‘bed’, *víctima* ‘victim’) maintain their normal feminine desinence. I start by presenting some assumptions regarding the structure of nominals and adjectives in Spanish and Basque. Then I discuss code-switching.

¹⁴ An anonymous reviewer asks what happens with unvalued features at LF. I do not have a well-articulated answer to this question. The logic of agreement failure suggests that LF is blind to unvalued features, since they are not interpretable. I hope to be able to explore this issue in future work.

6.2.1. Spanish

The assumption that concord is initiated in K leads us to posit a K in Spanish.¹⁵ K is indeed overt in Spanish as a genitive, dative or accusative (DOM). Since Spanish is a head-complement language, K spells out in pre-DP position (on these case markers see (Demonte 1995; Bleam 2003) among others):

(52)

- a. La construcción **de** la casa
The construction **GEN** the house
'The construction of the house'
- b. **Le** entreg-ó el paquete **a** Susana.
cl.dat deliver-past.3 the package **DAT** Susana
'She/he delivered Susana a package.'
- c. Susana vio **a** María.
Susana saw **DOM** María.
'Susana saw Maria.'

Since the case morphemes exhibit no gender and number, I propose that feature inheritance (as in (Chomsky 2008)) lowers these features onto D, thus turning D into a probe. This process of feature inheritance is identical to feature inheritance of ϕ -features by T from C, probably not by chance:

(53)



Gender and number features appear in an agglutinating fashion as separate morphemes in the determiner, adjective and noun. I assume that each of them constitutes a separate terminal. For instance, a definite determiner may look as follows:

(54)

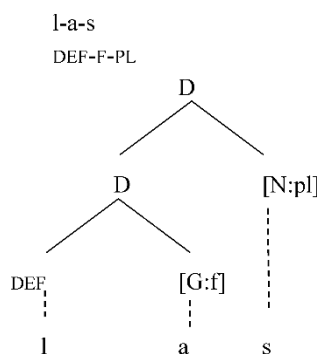

As the tree shows, I take the labeling node to be the head of the word and therefore the gender and number nodes are adjuncts selected by this head. There is a reason for this assumption. The gender exponents are the same for adjectives, quantifiers and determiners and a substantial number of nouns:

¹⁵ In fact, it should lead to the conclusion that K exists in every language that has concord, a consequence that I hope I will be able to explore in future work.

[a] for feminine and [o] for masculine (although there are a few adjectives that do not inflect for gender, which in my terms means that they do not select a G terminal).¹⁶ The number exponents are the same for all three: Zero for singular, [s] for plural. Consequently, I take it that the suffixes for gender and number are not category specific. Gender and number are not sublabels of D, *a* or *n*; rather, gender and number are features selected by these categories but they have no category themselves. Another consequence of this analysis is that the category Number has no spell out, not even when it is valued as plural. What spells out is the concord feature on *n*, *a* and D.

Let us look at the gender feature in more detail. There are two views on the gender feature of Spanish. (Roca 1989) takes it for granted that gender in Spanish has two values: Masculine and feminine. (Harris 1991) instead proposes that Spanish only has one gender, feminine; masculine is simply the absence of gender in his view. Harris' argument is based on the idea that when a conjunction or preposition needs to be used nominally, it always adopts masculine gender. For instance, if we want to say "I don't want to hear any *but*s" in Spanish, effectively nominalizing the conjunction *but*, the resulting gender is always masculine.

For the purposes of the current analysis, I split the difference between Harris and Roca in the middle. I assume that a Spanish *n* always selects a G terminal, and what type of G terminal is selected depends on the combination of *n* and the root. A G terminal can be valued, which I represent with *g*: [G:*g*]. Having a *g* feature makes the gender feature of the terminal valued (or checked) but nothing else. A G terminal may be valued and bear an additional feature that we can label *feminine*, which I formalize as [G:*g,f*]. Thus, I adopt the notion that feminine is the only specified gender feature but maintain that masculine stands for a valued gender terminal. Finally, a G terminal on some nouns has an unvalued gender feature, which I represent as [G:_]—this is the case of natural gender nouns. Thus, the combination $\sqrt{\text{puent}} + n$ (*puente*(m) 'bridge') selects a gender terminal with the feature structure [G:*g*]. The combination $\sqrt{\text{fuent}} + n$ (*fuentes*(f) 'fountain') selects a gender terminal with the feature structure [G:*g,f*]. Finally, the combination $\sqrt{\text{maestr}} + n$ (*maestro/maestra*(m/f) 'teacher') selects a gender terminal with the feature structure [G:_].

Therefore, I assume the following rules of Spanish grammar:

(55)

- a. [G:*g, f*] is selected by *n* + { $\sqrt{\text{mes-}}$ (table), $\sqrt{\text{cam-}}$ (bed), $\sqrt{\text{victim-}}$ (victim), ... }
- b. [G:*g*] is selected by *n* + { $\sqrt{\text{lech-}}$ (bed), $\sqrt{\text{pis-}}$ (floor) ... }
- c. [G:_] is selected by *n*

Most Spanish nouns select [G:*g,f*] or [G:*g*]. Only nouns with natural gender like *maestr-* 'teacher' select for a [G:_]. This flavor of *n* is also the one used when a preposition or conjunction is nominalized.

The next question is, how are these three feature structures spelled out? In the general case, the suffix [a] spells out feminine gender while [o] spells out masculine (but see footnote 16). I suggest the following two rules of vocabulary insertion:

(56)

- a. [G:*g,f*] \leftrightarrow [a]
- b. [G] \leftrightarrow [o]

¹⁶ There is a handful of nouns that end in [o] and are feminine, such as *soprano* and *mano* 'hand'. There is a more numerous group of nouns that end in [a] and are masculine (such as *tema* 'theme'). Finally, there is another group of nouns that end in a different vowel (usually [e]) or a consonant (*camión* 'truck', *fuentes* 'fountain') which can go either way. Trying to present a detailed analysis of noun gender in Spanish would take us too far afield (but see (Roca 1989; Harris 1991)). In essence, the strategy in a Distributed Morphology framework consists of formulating more specific rules of vocabulary insertion for these divergences from the general rule. I will ignore this issue from now on as it is not important for the proposals in this article.

That is, a [G] terminal with a *f* feature is spelled out as [a]. Otherwise, a [G] terminal with the feature type [G] is spelled out as [o] regardless of the feature value. In other words, [o] can spell out any gender terminal. This gives rise to three possible scenarios, represented in Example (57):

(57)

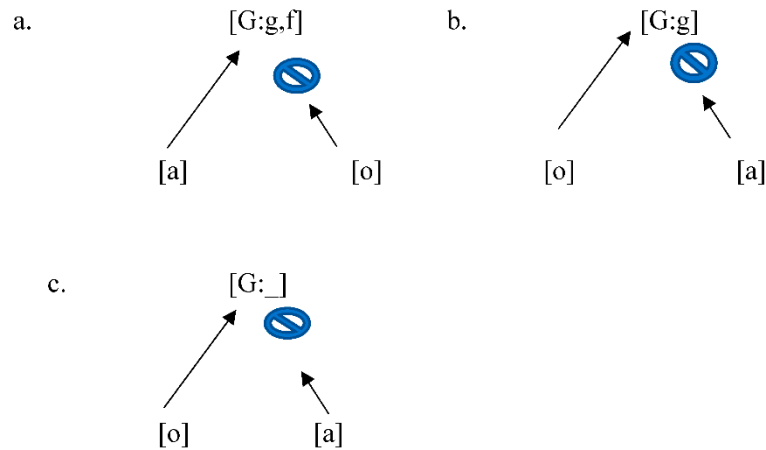

Example (57a) proposes that the feature structure [G:g,f] spells out as [a] while Example (57b) says that a valued gender feature [G:g] spells out as [o]. Example (57c) presents the default case (see Example (51)). If a gender feature is unvalued, [o] can be inserted because all that [o] requires is a terminal with a [G] feature. Later on, we will see that Example (57c) is active in providing exponents in the code-switched examples.

Let us now turn to number. It is tempting to regard number as a privative feature and take singular number to be simply the absence of number. However, (Fuchs et al. 2015) argue that singular is in fact a number value. With this conclusion in mind, I adopt the same approach to number that I adopt for gender. An [N] terminal can be valued and adopt the structure [N:num]. This is what we call singular. Plural involves an extra feature: [N:num, pl]. Number concord is straightforward: Plural spells out as [s], singular does not spell out:

(58)

| | | |
|------------|---|-----|
| [N:num,pl] | ↔ | [s] |
| [N] | ↔ | ∅ |

These two rules give rise to three possible scenarios. The number on the noun could be valued as plural and spelled out as [s], as shown in Example (59a). Or it could be valued without further specification, as in Example (59b). Finally, number could be unvalued and this is also spelled out as ∅ because the ∅ exponent just requires a terminal with a [N] feature; this is shown in Example (59c):

(59)

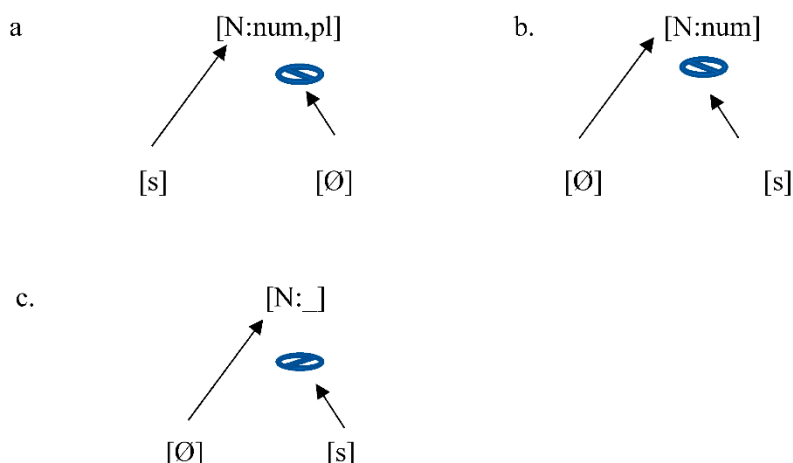

With this much background, we are ready to move on to the question of the difference between nouns with variable gender, like *maestr-* ‘teacher’ and nouns with fixed gender like *cama* ‘bed’ or *víctima* ‘victim’, which are always feminine (the latter can denote a male entity but its grammatical gender is always feminine). *Víctima* suggests that concord is an inward-looking operation in which the gender features are based on grammar without taking into consideration sex or natural gender. *Maestr-* on the other hand, suggests an outward-looking mechanism of concord.

In order to overcome the impasse, I propose that probing takes place in two stages, borrowing some ideas in (Kucerova 2018). As mentioned in Section 5, the logic of the phase system suggests that an inward-looking probe takes place before an outward-looking probe. Let us assume then that the first probe looks into the c-command domain. If features are valued, Agree takes place and we are done. This probe is insensitive to the natural gender of the denoted individual, and this is why *víctima* is feminine—giving rise to *la víctima* ‘the victim’ with feminine concord—even when denoting a male individual: The selection rule, Example (55a), ensures that the noun *víctima* has its gender valued as feminine. The general spell-out rule for feminine nouns, Example (56a), applies and [G:g,f] is spelled out as [a]. On the other hand, D has [G:_] (not K, because features have been lowered from K to D, recall 53). Thus, D probes and finds the gender feature on *n* and values its own [G:_] as [G:g,f].

Features remain unvalued after inward probing when they encounter an *n* with [ϕ :_], a natural gender noun such as *maestr-* ‘teacher’. If that is the case, the features of probe and goal are co-valued. (as in Examples (43–45)). Then the probing head looks into the discourse model and seeks a referent that has valued features (see (Kucerova 2018) for a formal implementation of outward-looking probing). If such a referent is found, the probing head values its features as well as those that were co-valued in the previous probing. Otherwise, they just stay unvalued.

We are now ready to go back to *maestr-*. D probes and finds [G:_] in *n*. While nothing is valued, all the gender features in the DP are co-valued (that is, those of the determiner, noun and adjective). Then D interacts with the discourse model, and finds a referent stored in the discourse model which is, say, feminine. Thus, the gender feature of D is valued as feminine and, by co-valuation, so is the gender of the *n* selecting *maestr-* as well as that of the adjective. Since *maestr-* is now selected by G[g,f], it falls under the general vocabulary insertion rule of Example (56a) and spells out as *maestra*.

Notice the following: If D can value gender in context, should it also value number in context? The answer is no: Inward probing takes place first and therefore it always finds the head Number. Consequently, a noun like *gente* ‘people’ is grammatically singular while the referent is plural.

Let us now turn to adjectives, which present a much simpler picture. There are two classes of adjectives in Spanish. A very numerous class inflects for both gender and number. The adjective *esplendid-* ‘splendid’ exemplifies this category:

(60)

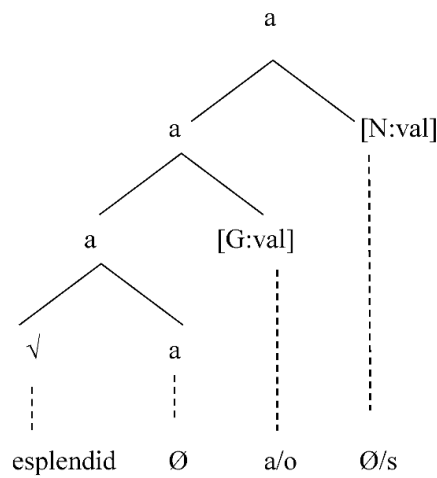

For adjectives—as well as determiners and other DP constituents—the correlation between [a] and masculine and [a] and feminine has no exceptions.

A relatively small group of adjectives only inflect for number. The adjective *azul* ‘blue’ serves as an example. For these adjectives like “*azul*”, there is no gender feature associated with *a*:

(61)

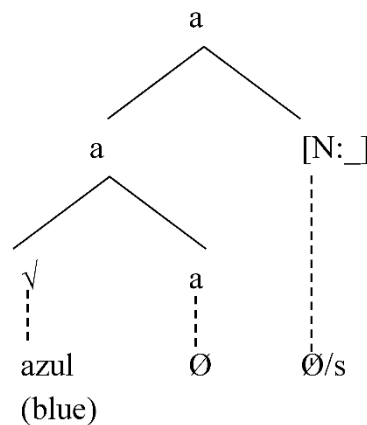

I take it that a rule of selection ensures that a subset of adjectives have a gender node which is always unvalued:

(62) [G:_] is selected by a + {√: guap- “pretty”, ... }

The rules of vocabulary insertion for the gender and number features of adjectives are the same as the general rules for nouns:

(63)

- [G:g,f] ↔ [a]
- [G] ↔ [o]
- [N:num,pl] ↔ [s]
- [N] ↔ ∅

Consequently, give rise to the same scenarios as the noun rules. Example (64) is in effect a copy of Example (57):

(64)

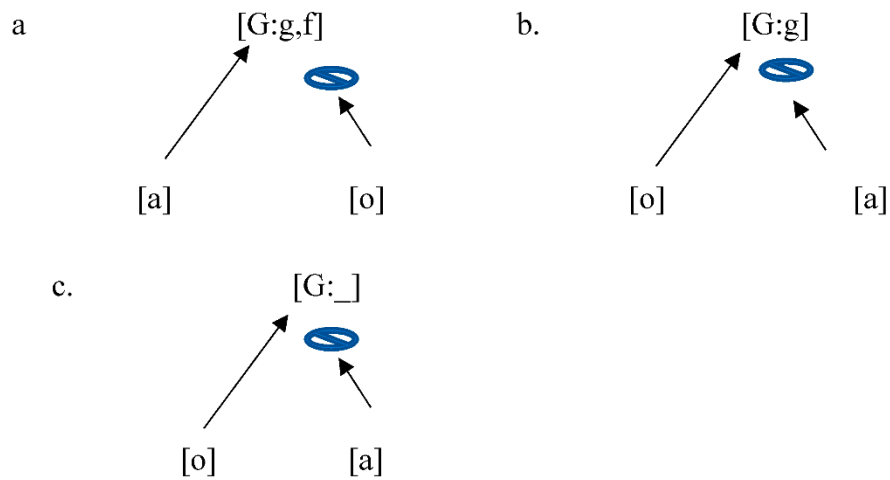

All adjectives are merged in the syntactic derivation with an unvalued gender feature, which becomes valued as $[G:g]$ or $[G:g,f]$ as the outcome of concord. The option of Example (64c) only arises if there is no valued gender in the structure, as in the case of nominalized prepositions of conjunctions.

6.2.2. Basque

A singular Basque KP has a determiner that spells out as $[a]$ and no inflection (except for the occasional gender concord), as shown in Example (7). This is represented in Example (65):

(65)

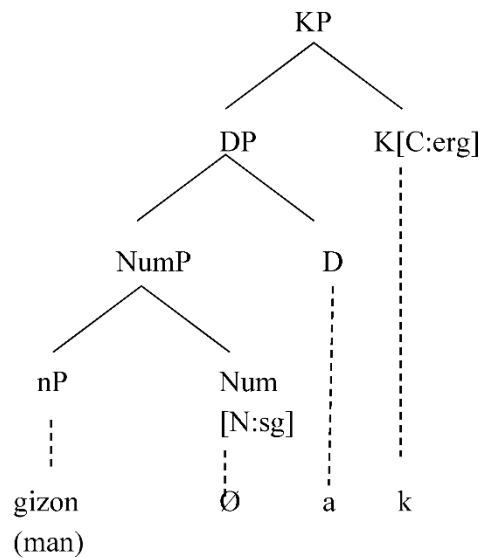

The plural noun phrase is more interesting because K has a suppletive form for plural, and no overt determiner. For instance, the suffix $[ei]$ spells out plural dative. I propose that in Basque when Num is plural, Num , D and K all fuse in one node:

(66)

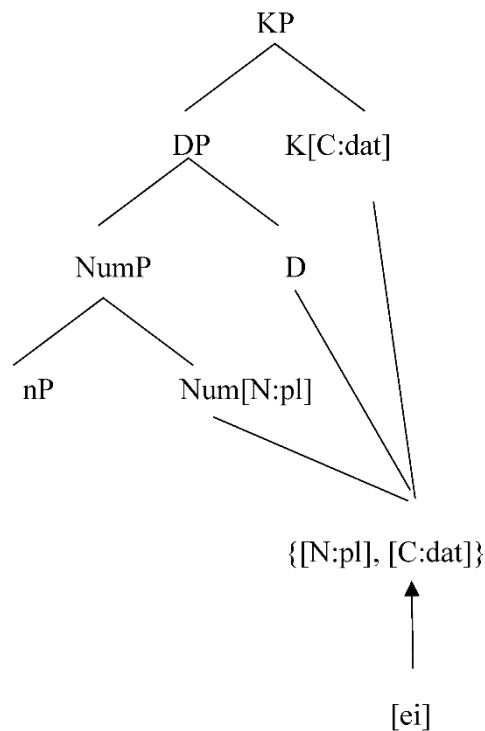

6.2.3. Code-Switching

We are now ready to discuss the Basque/Spanish code-switching examples. Recall that the data to be accounted for is the absence of plural agreement in the Spanish noun phrase as well as the usage of the masculine form for *maestr-* even when it refers to female individuals. Let us start with the latter, repeated here for the reader’s convenience:

(11) Spanish/*Basque*

- | | | | | | | |
|--------|------------------------------------------------|-----------------|-------------|--------------|-------|-------------|
| a. | Algún maestr-o | ancian-o-k | fabrika-n | bai | barre | egiten dut. |
| | Some teacher-M | old-M-ERG | factory-LOC | indeed laugh | do | aux |
| | ‘Some old teacher(m/f) laughs in the factory.’ | | | | | |
| b. | Maestr-o | ancian-o-ek | fabrika-n | bai | barre | egiten dute |
| | teacher-M | old-m-pl.erg | factory-LOC | indeed laugh | do | aux.PL |
| | ‘Some old teachers(m/f) laugh in the factory.’ | | | | | |
| c. (?) | Algún-a | maestr-a | ancian-a-k | | | |
| | some-F | teacher-F | old-F-ERG | | | |
| d. * | maestr-o-s | ancian-o-ek | | | | |
| | teacher-M-PL | old-m-pl.erg | | | | |
| e. * | maestr-a-s | ancian-a-ek | | | | |
| | teacher-F-PL | old-f-pl.erg | | | | |
| f. * | maestr-o | ancian-o-s-ek | | | | |
| | teacher-M | old-m-pl-pl.erg | | | | |

Assume a structure that has a K with no unvalued features. This K spells out as Basque case ([k] for ergative, [ri] for dative). Since K has no unvalued features, there is no probing for a value in the discourse model. The gender feature of *maestr-* remains unvalued and adopts the default form following the rule in Example (57c). This is shown in Example (67):

(67)

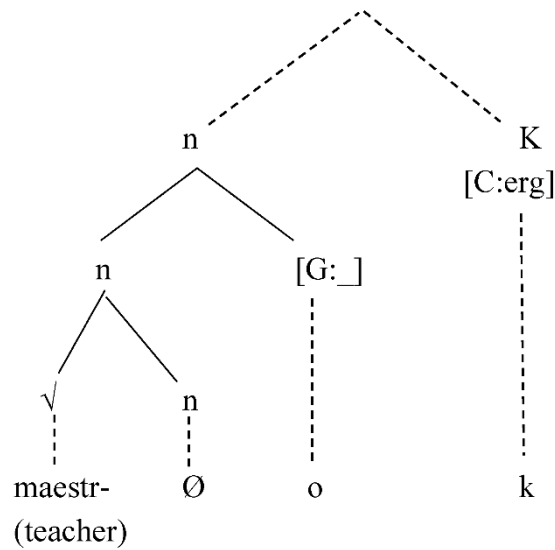

As mentioned, a Basque noun phrase may exhibit gender concord. In that circumstance, I take it that K has an unvalued gender feature. This gender feature leads to internal probing with the result that all gender features are co-valued. Then K can probe the discourse model and pick a feminine referent, thus valuing K as feminine and, by co-valuation, *n*.

Let us now account for *cama espléndida* and *cama espléndido* ‘splendid bed’ repeated here:

(16) Spanish/Basque

| | | | | | | | |
|----|-------------------------------------------|----------------------|----------------|---------------|---------|----------|---------|
| a. | Alguna | cam-a | esplendid-a-ri | izara berriak | ipini | dizkiot | |
| | some-F | bed-F | splendid-F-DAT | sheet new | put | aux | |
| | ‘I put a new sheet on the splendid bed.’ | | | | | | |
| b. | ? Algun | cam-a | esplendid-o-ri | izara | berriak | ipini. | dizkiot |
| | some | bed-F | splendid-M-DAT | sheet | new | put | aux |
| | ‘I put a new sheet on the splendid bed.’ | | | | | | |
| c. | Cam-a | esplendid-a-ei | izara berriak | berriak | ipini | dizkiot. | |
| | bed-f | splendid-f-dat.pl | sheet new | | put | aux.pl | |
| | ‘I put a new sheet on the splendid beds.’ | | | | | | |
| d. | * cam-a-s | esplendid-a-ei | | | | | |
| | bed-f-pl | splendid-F-DAT.PL | | | | | |
| e. | * cam-a-s | esplendid-a-s-ei | | | | | |
| | bed-f-pl | splendid-f-pl-dat.pl | | | | | |

The noun *cam-* has its own [G:g,f], which spells out as [a]. On the other hand, the adjective *esplendid-* has [G:_]. This unvalued gender feature can never be valued as long as K has no unvalued gender feature of its own that would trigger probing. The result is a default exponent, as we see in Example (16b). The structure of (16b) is shown in (68):

(68)

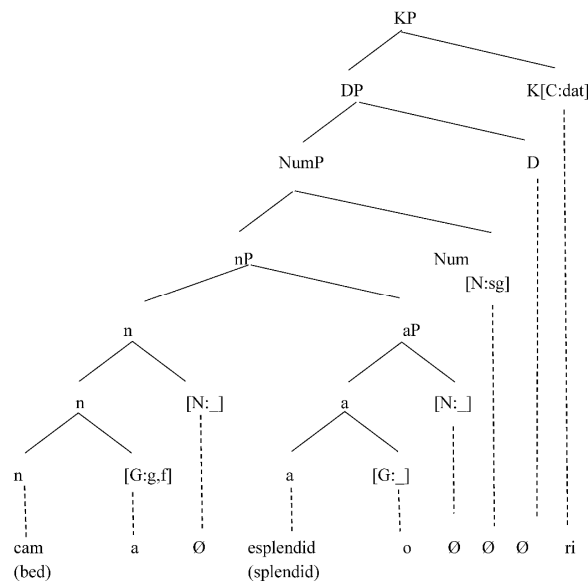

For those speakers that accept *espléndida cama*, Basque K has the feature structure $K\{[C:dat], [G:_]\}$. The $[G:_]$ of K probes and values the $[G:_]$ of the adjective via Multiple Agree.

The account of the ungrammaticality of any plural morphemes, shown in Example (16d,e) goes along the same lines. Since K has no $[N:_]$, there is no probing and the valued feature of Num never gets copied onto *n* or *a*. In fact, what we find is a fusion of Num, D and K, as in a regular Basque noun phrase:

(69)

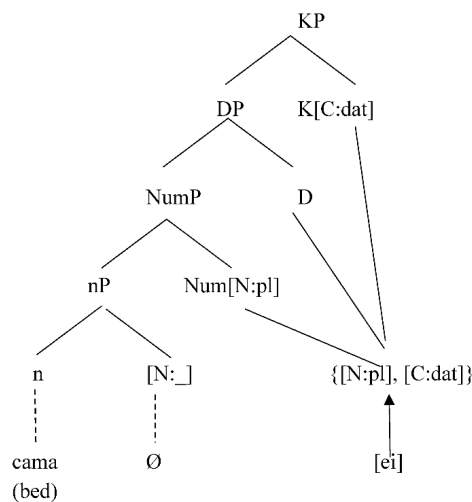

Let me now summarize the results of Section 6.2. If K hosts no unvalued gender, we obtain default forms on the adjective and on a natural gender noun like *maestr-*‘teacher’. On the other hand, *cam-*‘bed’ maintains its feminine gender and exponent because gender is selected by the noun and not dependent on concord. The default exponence is the result of a vocabulary insertion rule that inserts [o] into any gender terminal, regardless of the value—or lack of value—of the gender feature. If K hosts an unvalued gender, gender concord applies normally. The Basque K never has unvalued gender and as a consequence there is never number concord within the complement domain of K.

6.3. Russian/Kazakh

As we saw in Section 2, the presence of a Kazakh case marker makes concord within the KP impossible. The Russian adjective has an exponent that normally exhibits gender, number and case features (see (Halle and Matuschansky 2006)); however, in the context of code-switching it takes on an exponent that is usually associated with nominative, masculine and singular. (Auer and Muhamedova 2005) describe this suffix as default. This is similar to what we saw in the Spanish/Basque case, with the addendum of case concord, which is absent in Spanish, and the further complication of a three gendered system. Interestingly, the result of code-switching on the noun seems different: In Spanish/Basque code-switching the noun appears with its regular desinence if it has an inherent gender (*víctima*, *cama*), or with a default desinence if it does not have an inherent gender (*maestr-*). In Russian/Kazakh code-switching the Russian noun shows no morphology whatsoever in the singular. If there is a plural Kazakh morpheme, the Russian noun adopts a default singular and nominative value but, unexpectedly, does not adopt a default value for gender: Instead, the exponence exhibits the regular gender for the noun (for a detailed analysis of Russian noun morphology, see (Müller 2004)). An exploration of these differences will provide us with a deeper insight into the processes that go into fusion, exponence and default exponence.

I repeat the relevant Kazakh/Russian examples here:

(20) Russian/Kazakh

| | | | |
|-------------------|------------------|-----------------|--------|
| Vyssh- <i>ij</i> | shkol- <i>dī</i> | bitir- <i>d</i> | osinda |
| high-M.SG.NOM/ACC | school-ACC | finish-3.PAST | here |

'He finished high school here.'

(Auer and Muhamedova 2005, p. 43)

(22) Russian/Kazakh

| | | |
|--------------------------|----------------------------|----------------------|
| Knizh- <i>n-ij</i> | vismavk- <i>a-lar</i> | tema- <i>lar-ī-n</i> |
| book-buffer-M.SG.NOM/ACC | exhibition-F.SG.NOM/ACC-PL | topic-PL-POS3-ACC |

'the topics of the book exhibitions'

(Auer and Muhamedova 2005, p. 43)

In Example (20) the noun phrase is singular. The Kazakh suffix attaches directly to the root of the Russian adjective and noun. In Example (22) the noun phrase is plural. The adjective *knizh* remains without any Russian morphology but the head of the noun phrase, *vismavk* 'exhibition' has an affix [a] that expresses feminine, singular and nominative or accusative.

The different outcomes of the two code-switching situations hinge on the possibility of Fusion. The plural morpheme and the case morpheme are fused in Basque, as we saw in the previous section, but in Kazakh they form an agglutinating structure in which case follows plural. This allows the Kazakh plural to spell-out with an independent exponent. In Russian, case, gender and number are all fused in one exponent, while in Spanish gender and number head their independent terminals. This is what accounts for the differences in the code-switching data.

Let us start with the adjective. I follow (Auer and Muhamedova 2005) in taking the masculine, singular, nominative form of the adjective to be the default form. In Example (70), I use the suffix [i] as a stand-in for the default affix (in fact, adjectives fall into several declensional classes in Russian, see (Halle and Matuschansky 2006) for a description, but for our purposes this abstraction suffices). As such, this suffix simply can match any terminal that has some gender, number and case features. The suffix [aya] stands for feminine, singular and nominative, which means that it can match any terminal that has a feminine feature and some number and case feature. [oye] is the stand-in for neuter and some number and case. For further illustration, I also include the suffix [uyu], which spells out a terminal that has the features feminine, accusative and number:

(70)

| | | |
|-----------|----|-------|
| [G,N,C] | ←→ | [i] |
| [f,N,C] | ←→ | [aya] |
| [n,N,C] | ←→ | [oye] |
| [f,N,acc] | ←→ | [uyu] |

This feature organization helps us understand how [i] gets to be used when the inflection on the adjective is not valued: [i] matches any terminal that has gender, number and case, including unvalued gender, number and case. Any other suffix is too rich:

(71)

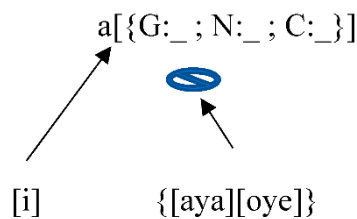

Let us now turn to the noun. Recall in Basque/Spanish, the noun appears with default inflection while in Russian/Kazakh, the noun appears with no inflection at all. Why?

Here is the reason: Gender and number in the Spanish noun are terminals within the complex word *n* and K has its own separate terminal. Thus, the presence of a Basque K without gender and number features does not affect the fact that *n* includes two terminals that need to be spelled-out. The Russian *n* and K are fused in one terminal with a portmanteau exponent. All of it is one terminal, and affixed to the noun. However, the Kazakh K is independent, it is not fused to anything else. Thus, when the Russian K is replaced with a Kazakh K the noun inflection is left without an exponent. Let us look at this claim in detail.

The operations that take place in a monolingual Russian noun phrase are represented in Examples (72) and (73). Example (72) represents the structure that the syntax component yields. The maximal word *n* contains three terminals for the root, *n* with gender, number and case—although here I have compressed these terminals into one for presentation. Num is singular. K has valued all its features. For the purposes of the example, I skip over the existence, or not, of D in Russian:

(72)

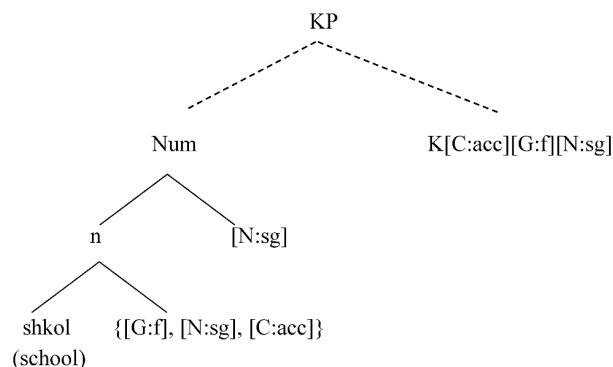

I believe it is plausible to assume that the noun suffix bears unvalued case and number features, valued only after probing by K. In Russian, all these features appear in a portmanteau affix attached to the noun. The structure in Example (73) represents the output of the fusion operation. Now K and the two nominal features are fused in one terminal. This terminal is spelled out as [a] (depending on declension, etc.).

(73)

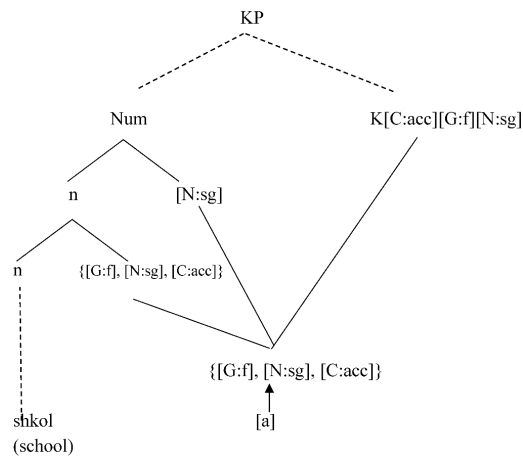

In code-switching, the resulting structures are depicted in Examples (74) and (76). Example (74) shows what happens when number is singular. Recall the output: We have a Russian noun with no inflection attached to a Kazakh K. The Kazakh K does not fuse with any other terminal, it spells out on its own. The next step would be fusion of Number with the nominal suffixes, but notice that there is a feature discrepancy, because the number feature of *n* is not valued (nor can it be valued, in the absence of probing from K) while Num is valued:

(74)

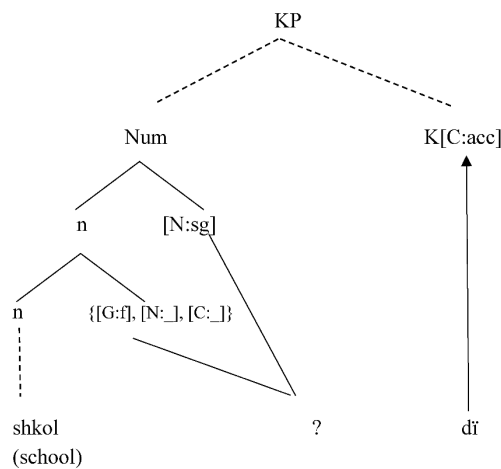

Since the [N] features of *n* and Num are incompatible, Fusion fails. Since Fusion has failed, there is no vocabulary insertion: The root *shkol* attaches directly to the Kazakh case affix

This analysis can now be used to understand the plural examples. Recall the phenomenon: We saw a Kazakh plural morpheme attached to the inflected noun, which appears with valued gender but default case and number:

(75) Russian/Kazakh

vismavk-a-lar
 exhibition-f.sg.nom/acc-pl
 'exhibitions'

(Auer and Muhamedova 2005, p. 43)

What scenario leads to this result? It is depicted in Example (76):

(76)

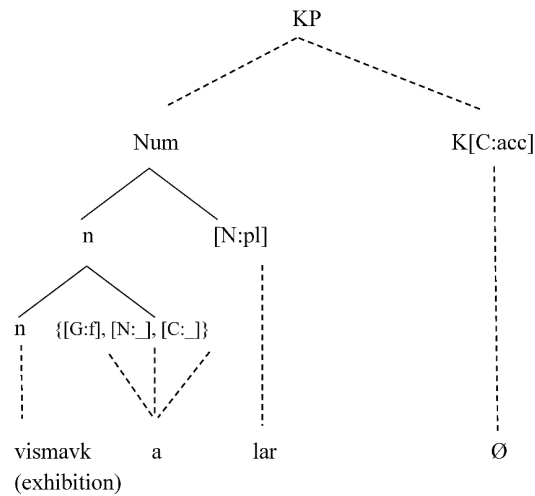

The Number is specified as plural. There is a morpheme in Kazakh that has exactly this value [lar] and so it is inserted in the corresponding slot, preventing fusion of Num with *n*. Note that there is no vocabulary in the Russian inventory that fits [N:pl], because all the vocabulary items in Russian that have a number feature also have case and gender features. That leaves the gender, number and case features on *n* free to fuse and find an exponent. This exponent is [a] which has the features [f,C,N].

To conclude this section: When the Russian noun is dominated by a Kazakh KP, concord disappears within the Russian nP. The only valued feature that can appear on the noun is gender in combination with plural because the noun itself selects for it and Fusion encounters no obstacles. In the singular, Fusion is blocked, there is no vocabulary insertion and the noun appears bereft of gender or number. Other than that, what we see is default forms.

6.4. German/Turkish

In Section 2 we saw that the German noun only inflects for plural. This inflection is probably the result of a readjustment rule because in code-switching it co-occurs with the Turkish plural morpheme, which led me to propose that German nominal plural affix is the output of a readjustment rule. I have nothing more to add to the discussion of German nouns in code-switching.

Let us now turn to adjective inflection. We have seen that in German/Turkish code-switching the adjective exhibits a minimal inflection [e]. The masculine accusative examples in (30a,b), repeated here, show that this morpheme [e] does not instantiate the weak or strong form of the adjective because both the weak and strong forms of masculine accusative are [en]. This leads to the conclusion that [e] must be acting as a default form of the adjective inflection, devoid of valued features. Within the terms of the analysis presented in these pages, merging a Turkish K with a German noun phrase leaves the adjective with unvalued gender, number and case features and only a default exponent can be inserted.

(30) German/Turkish

- | | | | | |
|----|----------|------------------------|--------------|-----------------|
| a. | neu-e | Film- <i>i</i> | sehen | <i>Yapıyor.</i> |
| | new | film(m)-ACC | see | do.PROG |
| | | 'seeing (a) new film' | | |
| b. | * neu-en | Film- <i>i</i> | <i>sehen</i> | <i>yapıyor</i> |
| | * new | film(m)-ACC | see | do.PROG |
| c. | neu-e | Haus- <i>u</i> | <i>sehen</i> | <i>yapıyor</i> |
| | new | house(n)-ACC | see | do.PROG |
| | | 'seeing (a) new house' | | |
| d. | * neu-es | Haus- <i>u</i> | <i>sehen</i> | <i>yapıyor</i> |
| | * new | house(n)-ACC | see | do.PROG |

In monolingual contexts, the suffix [e] on adjectives appears in a number of contexts in the weak and the strong inflection. The strong inflection has six different exponents ([er], [en], [es], [em], [en], [e]), while the weak inflection has only two ([e], [en]), which leads to extensive syncretism:

(77) Weak inflection

| | MASC | NEUT | FEM | PL |
|-----|------|------|-----|-----|
| NOM | -e | -e | -e | -en |
| ACC | -en | -e | -e | -en |
| DAT | -en | -en | -en | -en |
| GEN | -en | -en | -en | -en |

Strong inflection

| | MASC | NEUT | FEM | PL |
|-----|------------|-----------|-----|-----|
| NOM | -er | -es | -e | -e |
| ACC | -en | -es | -e | -e |
| DAT | -em | -em | -er | -en |
| GEN | (-es)/-en | (-es)/-en | -er | -er |

In the strong paradigm, [e] is used for feminine nominative and accusative as well as plural nominative and accusative, which suggests that it cannot possibly be regarded as a default form. Thus, in the code-switching examples in Example (30), it is unlikely that the [e] suffix is drawn from the strong paradigm.

Within the weak forms, the form [en] seems to be amenable to a rule-governed description: All the non-structural cases and all the plural forms bear [en]; additionally the accusative singular exponent is also [en] in combination with masculine gender. In other words, [en] seems to be the form used to spell out a terminal that has some case or number features. [e] seems to spell out a smaller but also more heterogeneous set of terminals—a property that defines a default form. It is this default characteristic that allows the weak inflection [e] to be used in code-switching contexts.

With these considerations in mind, I propose that the vocabulary insertion rules that insert exponents to weak adjectival inflection are as in Example (78):

(78)

- [G,pl,C] ↔ [en]
- [G,N,oblique] ↔ [en]
- [M,N,acc] ↔ [en]
- [G,N,C] ↔ [e]

Three different rules yield [en] as an exponent: A rule that spells out plural as [en], another one that spells out all non-structural cases (here labeled ‘oblique’) also as [en] and a third one that spells out masculine accusative as [en]. The exponent [e] simply spells out any gender, number and case token whenever the specification of features on the terminal does not favor [en].

If [e] can spell out an arbitrary bundle of number and case, it follows that it can be used to spell out a terminal that has only unvalued features, as in the code-switching examples in Example (30); in the same context [en] is always too specified:

(79)

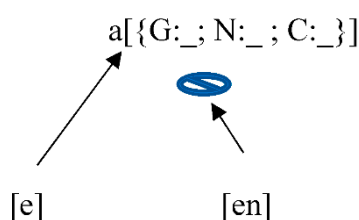

7. Conclusions

I have argued that K is intimately involved in concord, as shown when a non-concord K merges with a concord noun phrase, disrupting the concord system within the noun phrase. I have presented evidence from three pairs of code-switching languages to support this analysis. I have further suggested that K is a phase head and initiates concord via Agree.

The output of this loss of concord is a set of default exponents. A default exponent appears when an unvalued feature reaches vocabulary insertion. The default exponent is the one that has no particular values for the feature or lacks any additional features. A default exponent can be inserted into a terminal with a matching unvalued feature. Differences in output between the three code-switching varieties were shown to be the result of Fusion and the actual morphosyntactic features involved.

Funding: This research received no external funding.

Acknowledgments: First and foremost, I would like to thank the language consultants who so patiently agreed to share their knowledge of their languages with me: Lucía Badiola, Birhan Şengöz, Mukkades Ulusal, and Janire Zalbidea. I would also like to thank the reviewers for *Languages* as well as Carmen Parafita-Couto for their detailed comments. Finally, I would like to thank the audience at the Bilingualism in the Hispanic and Lusophone World 2019 in Utrecht for their challenging questions. All errors are mine.

Conflicts of Interest: The authors declare no conflict of interest.

References

- Alexiadou, Artemis, Liliane Haegeman, and Melita Stavrou. 2007. *Noun Phrase in the Generative Perspective*. Berlin: Mouton de Gruyter.
- Alexiadou, Artemis, Terje Lohndal, Tor Åfarli, and Maren Berg Grimstad. 2015. Language mixing: A Distributed Morphology approach. In *Proceedings of NELS*. Edited by Thuy Bui and Denis Ozildiz. Amherst: GLSA Publications, pp. 25–38.
- Auer, Peter, and Raihan Muhamedova. 2005. ‘Embedded language’ and ‘matrix language’ in insertional language mixing: Some problematic cases. *Rivista di Linguistica* 17: 35–54.
- Badiola, Lucía, and Ariane Sande. 2018. Gender assignment in Basque mixed Determiner Phrases: A study of Gernika Basque. In *Code-Switching—Experimental Answers to Theoretical Questions*. Edited by Luis López. Amsterdam: John Benjamins, pp. 15–38.
- Bittner, Maria, and Ken Hale. 1992. The structural determination of case and agreement. *Linguistic Inquiry* 27: 1–68.
- Baker, Mark. 2008. *The Syntax of Agreement and Concord*. Cambridge: Cambridge University Press.
- Bleam, Tonia. 2003. Properties of the Double Object Construction in Spanish. In *A Romance Perspective on Language Knowledge and Use*. Edited by Rafael Núñez-Cedeño, Luis López and Richard Cameron. Amsterdam and Philadelphia: John Benjamins, pp. 233–52.
- Brown, Dunstan. 2016. Defaults and overrides in morphological description. In *Cambridge Handbook of Morphology*. Edited by Andrew Hippisley and Gregory Stump. Cambridge: Cambridge University Press, chp. 2. pp. 272–96.
- Carstens, Vicki. 2001. Multiple agreement and case deletion: Against φ -incompleteness. *Syntax* 4: 147–63. [[CrossRef](#)]
- Cetinoglu, Özlem. 2017. A Turkish-German Code-Switching Corpus. Paper presented the 11th Linguistic Annotation Workshop 2016, Valencia, Spain, April 3; pp. 4215–20.
- Chomsky, Noam. 2000. Minimalist inquiries: The Framework. In *Step by Step: Essays on Minimalist Syntax in Honor of Howard Lasnik*. Edited by Roger Martin, David Michaels and Juan Uriagereka. Cambridge: MIT Press, pp. 89–155.
- Chomsky, Noam. 2008. On phases. In *Foundational Issues in Linguistic Theory: Essays in Honor of Jean-Roger Vergnaud*. Edited by Robert Freidin, Carlos P. Otero and María Luisa Zubizarreta. Cambridge: MIT Press, pp. 133–66.
- Cinque, Guglielmo. 2010. *The Syntax of Adjectives*. Cambridge: MIT Press.
- Danon, Gabi. 2011. Agreement and DP-internal feature distribution. *Syntax* 14: 297–317. [[CrossRef](#)]
- Demonte, Violeta. 1995. Dative alternation in Spanish. *Probus* 7: 5–30. [[CrossRef](#)]

- Ebert, Shane, and Brad Hoot. 2018. That-trace effects in Spanish-English code-switching. In *Code-Switching: Experimental Answers to Theoretical Questions*. Edited by Luis López. Amsterdam and Philadelphia: John Benjamins, pp. 101–46.
- Embick, David. 2015. *The Morpheme. A Theoretical Introduction*. Berlin: Mouton de Gruyter.
- Finer, Daniel. 2014. Movement triggers and reflexivization in Korean-English code switching. In *Grammatical Theory and Bilingual Code-Switching*. Edited by Jeff MacSwan. Cambridge: MIT Press, pp. 37–62.
- Frampton, John, and Sam Gutmann. 2006. How sentences grow in the mind: Agreement and selection in efficient minimalist syntax. In *Agreement Systems*. Edited by Cedric Boeckx. Amsterdam: John Benjamins Publishing Company, pp. 121–57.
- Fuchs, Zuzanna, Maria Polinsky, and Gregory Scontras. 2015. The differential representation of number and gender in Spanish. *The Linguistic Review* 32: 703–37. [[CrossRef](#)]
- Gardner-Chloros, Penelope. 2009. *Code-Switching*. Cambridge: Cambridge University Press.
- Göksel, Aslı, and Celia Kerslake. 2005. *Turkish: A Comprehensive Grammar*. London: Routledge.
- Goldrick, Matthew, Michael Putnam, and Lara Schwarz. 2016. Coactivation in bilingual grammars: A computational account of code mixing. *Bilingualism: Language and Cognition* 19: 857–76. [[CrossRef](#)]
- González-Vilbazo, Kay. 2005. *Die Syntax des Code-Switching. Esplugisch: Sprachwechsel an der Deutschen Schule Barcelona*. Ph.D. dissertation, Universität zu Köln, Cologne, Germany. Unpublished.
- González-Vilbazo, Kay, Laura Bartlett, Sarah Downey, Shane Ebert, Jeanne Heil, Brian Koronkiewicz, and Sergio Ramos. 2012. Methodological considerations in code-switching research. *Studies in Hispanic and Lusophone Linguistics* 6: 118–38. [[CrossRef](#)]
- Grimstad, Maren Berg, Terje Lohndal, and Tor Åfarli. 2014. Language mixing and exoskeletal theory: A case study of word-internal mixing in American Norwegian. *Nordlyd* 41: 213–37. [[CrossRef](#)]
- Gullberg, Marianne, Peter Indefrey, and Pieter Muysken. 2009. Research techniques for the study of code-switching. In *The Cambridge Handbook on Linguistic Code-Switching*. Edited by Barbara Bullock and Almeida J. Toribio. Cambridge: Cambridge University Press, pp. 21–39.
- Halle, Morris, and Alec Marantz. 1993. Distributed morphology and the Pieces of inflection. In *The View from Building 20*. Edited by Ken Hale and Samuel Jay Keyser. Cambridge: MIT Press, pp. 111–76.
- Halle, Morris, and Ora Matuschansky. 2006. The morphophonology of Russian adjectival inflection. *Linguistic Inquiry* 37: 351–404. [[CrossRef](#)]
- Halle, Morris. 1997. Distributed Morphology: Impoverishment and fission. In *Papers at the Interface. MIT Working Papers in Linguistics*. Edited by Benjamin Bruening, Yoonjung Kang and Martha Jo McGinnis. Amsterdam: John Benjamins Publishing Company, pp. 425–49.
- Harbert, Wayne. 2007. *The Germanic Languages*. Cambridge: Cambridge University Press.
- Harris, Jim. 1991. The exponence of gender in Spanish. *Linguistic Inquiry* 22: 27–62.
- Harris, James. 1994. The syntax-phonology mapping in Catalan and Spanish clitics. *MIT Working Papers in Linguistics* 21: 321–53.
- Haug, Dan Trygve Truslew, and Tatiana Nikitina. 2016. Feature sharing in agreement. *Natural Language and Linguistic Theory* 34: 865–910. [[CrossRef](#)]
- Hicks, Christopher. 2018. The parameterisation of Number. *Studia Linguistica* 72: 509–36. [[CrossRef](#)]
- Hualde, José Ignacio, and Jon Ortiz de Urbina. 2003. *A Grammar of Basque*. Berlin: De Gruyter.
- Kiparski, Paul. 1973. Elsewhere in phonology. In *A Festschrift for Morris Halle*. Edited by Stephen R. Anderson and Paul Kiparsky. New York: Harper & Row, pp. 93–106.
- Kramer, Ruth. 2015. *The Morphosyntax of Gender*. Oxford: Oxford University Press.
- Kucerova, Ivona. 2018. ϕ -features at the syntax-semantics interface: Evidence from nominal inflection. *Linguistic Inquiry* 49: 813–45. [[CrossRef](#)]
- Landau, Idan. 2016. DP-internal semantic agreement: A configurational analysis. *Natural Language and Linguistic Theory* 34: 975–1020. [[CrossRef](#)]
- López, Luis. 2007. *Locality and the Architecture of Syntactic Dependencies*. London: Palgrave.
- Mahootian, Sharhad, and Beatrice Santorini. 1996. Code-switching and the complement-adjunct distinction. *Linguistic Inquiry* 27: 464–79.
- Marantz, Alec. 1997. No escape from syntax: Don't try morphological analysis in the privacy of your own lexicon. In *Proceedings of the 21st Penn Linguistics Colloquium*. Edited by Alexis Dimitriadis, Laura Siegel,

- Clarissa Surek-Clark and Alex Williams. Upenn Working Papers in Linguistics. Philadelphia: University of Pennsylvania, pp. 221–25.
- MacSwan, Jeff. 1999. *A minimalist approach to intrasentential code switching*. New York: Garland Press.
- MacSwan, Jeff. 2000. The architecture of the bilingual language faculty: Evidence from intrasentential code switching. *Bilingualism, Language and Cognition* 3: 37–54. [[CrossRef](#)]
- Muhamedova, Raihan. 2006. *Untersuchung zum Kasaschisch-Russischen Code-Mixing (mit Ausblicken auf den Uigurisch-Russischen Sprachkontakt)*. Munich: Lincom Europa.
- Muhamedova, Raihan. 2016. *A Grammar of Kazakh*. London: Routledge.
- Müller, Gereon. 2004. On Decomposing Inflection Class Features: Syncretism in Russian Noun Inflection. In *Explorations in Nominal Inflection*. Edited by Gereon Müller, Lutz Gunkel and Gisela Zifonun. Berlin: Mouton de Gruyter, pp. 189–227.
- Munarriz-Ibarrola, Amaia, Carmen Parafita-Couto, and Emma Vanden Wyngaerd. 2018. Methodologies for intra-sentential code-switching research. *Linguistic Approaches to Bilingualism* 8: 1–4. [[CrossRef](#)]
- Myers-Scotton, Carol. 1997. *Duelling Languages*. Oxford: Oxford University Press.
- Norris, Mark. 2012. Towards an analysis of concord (in Icelandic). In *Proceedings of the West Coast Conference on Formal Linguistics*. Edited by Jaehoon Choi, E. Alan Hogue, Jeffrey Punske, Deniz Tat, Jessamyn Schertz and Alex Trueman. Somerville: Cascadilla Press, pp. 205–13.
- Norris, Mark. 2014. A Theory of Nominal Concord. Ph.D. dissertation, University of California Santa Cruz, Santa Cruz, CA, USA. Unpublished.
- Parafita-Couto, Maria Carmen, Amaia Munárriz, Irantzu Epelde, Margaret Deuchar, and Beñat Oyarçabal. 2015. Gender conflict resolution in Basque-Spanish mixed DPs. *Bilingualism: Language and Cognition* 18: 304–23. [[CrossRef](#)]
- Poplack, Shana. 1980. ‘Sometimes I’ll start a sentence in Spanish y termino en español’: Toward a Typology of Code-Switching. *Linguistics* 18: 581–618. [[CrossRef](#)]
- Preminger, Omer. 2014. *Agreement and its Failures*. Cambridge: MIT Press.
- Puškar, Zorica. 2018. Interactions of gender and number agreement: Evidence from Bosnian/Croatian/Serbian. *Syntax* 21: 275–318. [[CrossRef](#)]
- Richards, Norvin. 2010. *Uttering Trees*. Cambridge: MIT Press.
- Richards, Norvin. 2015. *Contiguity Theory*. Cambridge: MIT Press.
- Riksem, Rita Ramsevik, Maren Berg Grimstad, Terjen Lohndal, and Tor Åfarli. 2019. Language mixing within verbs and nouns in American Norwegian. *Journal of Comparative Germanic Linguistics* 22: 189–209. [[CrossRef](#)]
- Roca, Iggy. 1989. The organization of grammatical gender. *Transactions of the Philological Society* 87: 1–32. [[CrossRef](#)]
- Roehrs, Dorian. 2015. Inflections in pre-nominal adjectives in Germanic: Main types, subtypes and subset relations. *Journal of Comparative Germanic Linguistics* 18: 213–71. [[CrossRef](#)]
- Toorsarvandani, Maziar, and Coppe Van Urk. 2013. The syntax of nominal concord: What ezafe in Zazaki shows us. *North East Linguistic Society (NELS)* 43: 209–20.
- Vergara, Daniel. 2018. Basque complementizers under the microscope: A Spanish/Basque code-switching approach. In *Code-Switching: Experimental Answers to Theoretical Questions*. Edited by Luis López. Amsterdam and Philadelphia: John Benjamins, pp. 221–54.
- Wiltschko, Martina. 2008. The syntax of non-inflectional plural marking. *Natural Language and Linguistic Theory* 26: 639–94. [[CrossRef](#)]
- Zwicky, Arnold. 1985. How to describe inflection. *Berkeley Linguistics Society* 11: 372–86. [[CrossRef](#)]
- Åfarli, Tor. 2015. Hybrid verb forms in American Norwegian and the analysis of the syntactic relation between the verb and its tense. In *Germanic Heritage Languages in North America*. Edited by Janne Bondi Johannessen and Joseph. C. Salmons. Leiden: Brill, pp. 161–77.

