

Review

A Recycling Hydrogen Supply System of NaBH₄ Based on a Facile Regeneration Process: A Review

Liuzhang Ouyang ^{1,2,3}, Hao Zhong ^{1,2}, Hai-Wen Li ^{4,*}  and Min Zhu ^{1,2,*}

¹ School of Materials Science and Engineering, Key Laboratory of Advanced Energy Storage Materials of Guangdong Province, South China University of Technology, Guangzhou 510641, China; meouyang@scut.edu.cn (L.O.); haozhong.gz@gmail.com (H.Z.)

² China-Australia Joint Laboratory for Energy & Environmental Materials, South China University of Technology, Guangzhou 510641, China

³ Key Laboratory for Fuel Cell Technology in Guangdong Province, Guangzhou 510641, China

⁴ Kyushu University Platform of Inter/Transdisciplinary Energy Research, International Research Center for Hydrogen Energy and International Institute for Carbon-Neutral Energy, Kyushu University, Fukuoka 819-0395, Japan

* Correspondence: li.haiwen.305@m.kyushu-u.ac.jp (H.-W.L.); memzhu@scut.edu.cn (M.Z.)

Received: 24 October 2017; Accepted: 5 January 2018; Published: 6 January 2018

Abstract: NaBH₄ hydrolysis can generate pure hydrogen on demand at room temperature, but suffers from the difficult regeneration for practical application. In this work, we overview the state-of-the-art progress on the regeneration of NaBH₄ from anhydrous or hydrated NaBO₂ that is a byproduct of NaBH₄ hydrolysis. The anhydrous NaBO₂ can be regenerated effectively by MgH₂, whereas the production of MgH₂ from Mg requires high temperature to overcome the sluggish hydrogenation kinetics. Compared to that of anhydrous NaBO₂, using the direct hydrolysis byproduct of hydrated NaBO₂ as the starting material for regeneration exhibits significant advantages, i.e., omission of the high-temperature drying process to produce anhydrous NaBO₂ and the water included can react with chemicals like Mg or Mg₂Si to provide hydrogen. It is worth emphasizing that NaBH₄ could be regenerated by an energy efficient method and a large-scale regeneration system may become possible in the near future.

Keywords: sodium borohydride (NaBH₄); hydrolysis; regeneration

1. Introduction

Hydrogen [1–3] has been widely accepted as a clear energy carrier [4–6] due to its high energy density (142 MJ/kg) [7–9] and its environmentally friendly byproduct (water) [10,11]. It can be generated via numerous strategies, such as the electrolysis of water [12–14] and photocatalytic water splitting [15–18]. Supplying hydrogen to end users on demand requires safe and efficient methods of hydrogen storage.

Hydrides, storing hydrogen in a safe and compact way without using high pressure, like 70 MPa, or extremely low temperature, like 20 K (liquid hydrogen), have attracted great interest as promising hydrogen storage materials. Though a great deal of progress has been achieved on the development of solid-state hydrogen storage materials in the previous decades, no material with reasonably good hydrogen absorption and desorption performance at near room temperature has been developed to meet all the requirements for onboard hydrogen storage [19–23]. Hydrolysis of hydrides, such as MgH₂, ammonia borane (AB), and NaBH₄, generating hydrogen with relatively high capacity at room temperature, is attracting increasing interest for hydrogen supply on demand [24–26]. Due to the low cost of Mg and the high capacity of MgH₂ (7.6 wt %) [27–29], much attention has been paid to MgH₂ hydrolysis [30–32]. However, the reaction is interrupted easily by the formation

of a magnesium hydroxide layer [33,34]. Compared with MgH_2 , AB possesses higher hydrogen capacity (19.6 wt %) [35–37]. AB is stable in water and its solubility is as high as 33.6 g/100 mL [38,39], which provides a simple application of AB aqueous solution. Studies have been focused on the development of catalysts to accelerate and control the reaction [40–42]. However, the high cost of AB [43] and the difficulty of AB regeneration are major blocks for the application of AB hydrolysis [44,45].

NaBH_4 hydrolysis is another promising system for hydrogen generation. It has relatively high hydrogen capacity (10.8 wt %) [46–48] and releases hydrogen with high purity at relatively low operational temperature with a controllable process [24,49,50]. Many studies have been focused on the hydrolysis property improvements [51–54]. Unfortunately, a no-go recommendation on NaBH_4 hydrolysis for onboard applications was given by the US Department of Energy (DOE) [55]. One of the key reasons are the cost and the regeneration of NaBH_4 [56]. As a result, more focus was shifted into the synthesis and regeneration of NaBH_4 . For commercial NaBH_4 production, the Brown-Schlesinger process [57] and the Bayer process [58] are the most popular methods. The Brown-Schlesinger process produces NaBH_4 via the reaction between trimethylborate ($\text{B}(\text{OCH}_3)_3$, TMB) and sodium hydride (NaH), which should be produced by reacting Na and H_2 . Different from it, the Bayer process is based on the reaction among borax ($\text{Na}_2\text{B}_4\text{O}_7$), Na, H_2 , and silicon oxide (SiO_2) at 700 °C to synthesize NaBH_4 . Although the above methods are mature technologies and straightforward procedures, the raw materials are too expensive for NaBH_4 hydrolysis applications. Thus, the raw materials have been studied to develop suitable NaBH_4 synthesis methods. Instead of Na, MgH_2 was used to react with $\text{Na}_2\text{B}_4\text{O}_7$ to synthesize NaBH_4 by ball milling at room temperature. Here, Na_2CO_3 addition could increase NaBH_4 yield up to 78% [59]. This method provides not only a new reducing agent (MgH_2) for NaBH_4 synthesis, but also a new way of ball milling. Enlightened by it, ball milling became popular in NaBH_4 synthesis studies, in which Na and MgH_2 reacted with B_2O_3 by ball milling with the NaBH_4 yield of only 25% [60]. When Na was substituted by low-cost NaCl, NaBH_4 could also be produced [61]. Later, high-pressure ball milling was also tried to synthesize NaBH_4 , for instance, NaH was reacted with MgB_2 by ball milling under 12 MPa hydrogen pressure with the NaBH_4 yield of about 18%.

From the point of cost reduction in synthesis and post-usage of NaBH_4 , the regeneration of NaBH_4 from the byproduct of hydrolysis (see Equation (1) [62]) is in great need for the recycling of the hydrogen supply system of NaBH_4 :



According to this, the Brown-Schlesinger process was modified using NaBO_2 as source of boric acid to synthesis of NaBH_4 [63], the drawback of which the byproduct $\text{NaBO}_2 \cdot x\text{H}_2\text{O}$ of hydrolysis needs to be dried first. As another alternative, the electrochemical route was proposed for recycling NaBO_2 to NaBH_4 . Direct electrolysis of a NaBO_2 solution was first proven feasible for regeneration of NaBH_4 with using palladium (Pd) or platinum (Pt) as electrodes, where the conversion ratio of NaBO_2 was about 17% within 48 h [64]. Later, an Ag electrode was also employed in the recycling of NaBO_2 ; unfortunately, the quantities of reborn NaBH_4 were too low to be measured [65]. In contrast to the commercial gas-solid methods, the electrochemical method possesses ultra-low efficiency and complex processes, using precious metal electrodes, although the NaBO_2 solution that is the main byproduct of NaBH_4 hydrolysis can be used directly without dehydration. Therefore, an efficient and simple route is most urgently needed for the cycling of NaBO_2 into NaBH_4 .

In this paper, we discuss the state-of-the-art progress on the regeneration of NaBH_4 from anhydrous NaBO_2 or the direct byproduct $\text{NaBO}_2 \cdot x\text{H}_2\text{O}$. In particular, the regeneration steps and the yield of NaBH_4 in each process are summarized in Scheme 1 and the facile regeneration process is also proposed. This review can provide important insights for the recycling hydrogen supply system with high efficiency.

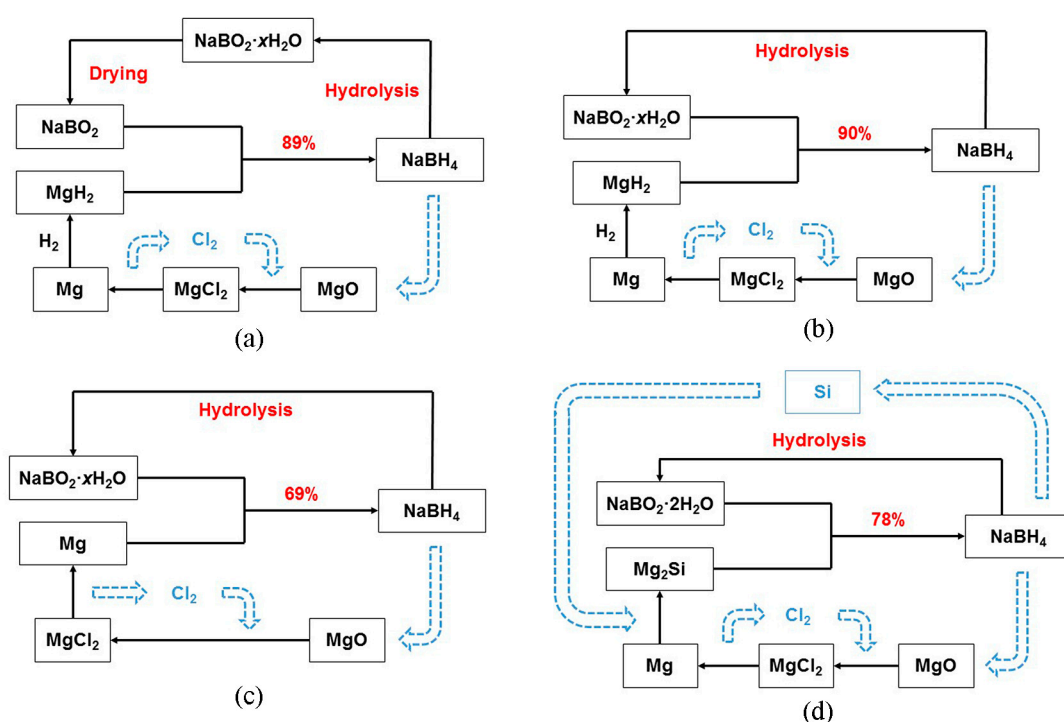

Scheme 1. Flowchart of (a) NaBH₄ regeneration via the reaction between MgH₂ and NaBO₂. (b) NaBH₄ regeneration via the reaction between MgH₂ and NaBO₂·xH₂O. (c) NaBH₄ regeneration via the reaction between Mg and NaBO₂·xH₂O. (d) NaBH₄ regeneration via the reaction between Mg₂Si and NaBO₂·2H₂O. Numbers indicate the yield of NaBH₄.

2. NaBH₄ Regeneration via the Reaction between Metal or Other Hydrides and NaBO₂

As the hydrolysis byproduct of NaBH₄, NaBO₂ is the main research object of NaBH₄ regeneration studies. Many approaches have been adopted to reduce NaBO₂ to NaBH₄ with different reducing agents. Among the reducing agent, MgH₂ is the most effective. Kojima et al. [66] reacted MgH₂ with NaBO₂ under 550 °C and 7 MPa hydrogen pressure to regenerate NaBH₄, and about 97% NaBH₄ yield was achieved, while the high reaction temperature and high hydrogen pressure leads to a high energy consumption. Therefore, the thermochemistry method was substituted by room temperature ball milling in this reaction. Hsueh et al. [67], Kong et al. [68] and Çakanyildirim et al. [69] used MgH₂ to react with NaBO₂ by ball milling under argon. All of their NaBH₄ yields were over 70%, which strongly indicated that ball milling is suitable for the reaction between MgH₂ and NaBO₂. Based on the thermodynamics calculation, we found the maximum energy efficiency of the cycle was 49.91% [70]. Recently, we found that the addition of hydrogen pressure and methanol could further increase the NaBH₄ yield by this method [71]. The highest NaBH₄ yield could be increased to 89%. In addition to the energy consumption, raw material is another issue that should be considered. Hydrogenation of Mg to produce MgH₂ is hard due to its sluggish kinetics, thus resulting in the high cost and high energy consumption in MgH₂ production. By modifying the hydrogenation of Mg using Mg-based alloy, the above issue can be partly solved. Following this observation, we tried to use Mg₃La hydrides to react with NaBO₂ for its advantage of room temperature hydrogenation and low hydrogen purity requirement and found that NaBH₄ could be produced (Figure 1a) [70]. However, introduction of other elements influences the regeneration reaction of MgH₂. Directly using Mg and H₂ in the regeneration may solve the MgH₂ production problem. Kojima et al. [66] tried to directly react Mg with NaBO₂ under hydrogen, but the yield was extremely low, which may have resulted from the produced MgO obstruction. To promote the yield, Kojima et al. [66] found that Si addition could remarkably increase the NaBH₄ yield and Liu et al. [72] found transition metals, like Ni, Fe, and Co,

addition could also promote the NaBH_4 yield. However, both Si and transition metals keep their own elemental form after the reaction, indicating that such additions would reduce the absolute NaBH_4 yield. A pre-milling of the reactants was then found that could also promote the yield. Eom et al. [73] proposed a large-scaled method for reacting Mg with NaBO_2 to synthesize NaBH_4 . After 1 h of ball milling of the reactants, about 69% yield was achieved under 600 °C and 5.5 MPa hydrogen pressure.

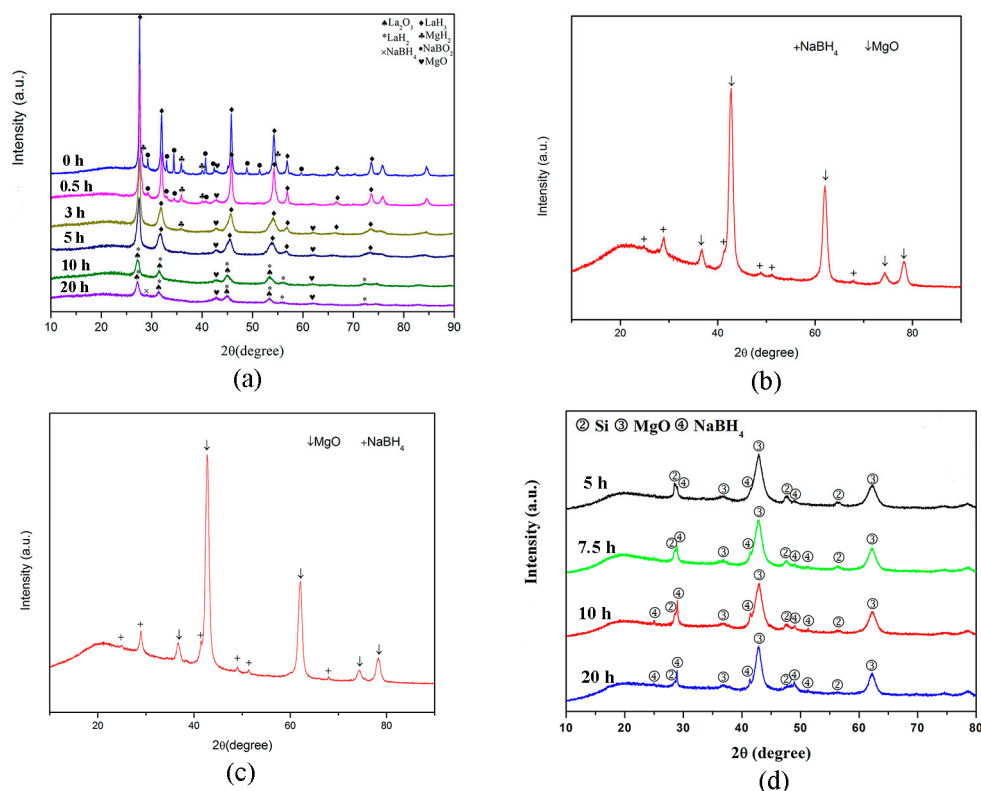
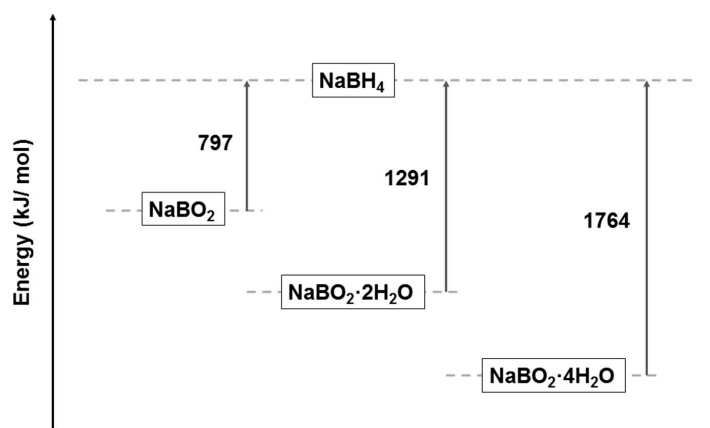

Figure 1. (a) XRD patterns of the $\text{NaBO}_2\text{-Mg}_3\text{La}$ hydride mixture and the product after ball milling the $\text{NaBO}_2\text{-Mg}_3\text{La}$ hydride mixture. (b) XRD pattern of products via ball-milling the mixture of $\text{NaBO}_2 \cdot 2\text{H}_2\text{O}$ and MgH_2 in 1:5.5 mol ratio for 15 h. (c) XRD pattern of products via ball-milling the mixture of $\text{NaBO}_2 \cdot 2\text{H}_2\text{O}$ and Mg in 1:5 mole ratio for 15 h. (d) XRD patterns of the products after ball milling Mg_2Si and $\text{NaBO}_2 \cdot 2\text{H}_2\text{O}$ mixtures (in 2:1 mol ratio).

For other reducing agents, the Gibbs free energy of the reaction using Ca is much lower than that of Mg. In addition, we found that the energy efficiency of the cycle using Ca is about 43%. For the experiment, Eom et al. tried to substitute Mg by Ca [73], but few NaBH_4 was regenerated. Another low cost and abundant metal reductant, Al, was studied by few researchers on NaBH_4 regeneration. The only work with respect to Al was reported by Liu et al. [74], expressing that Al could not react with NaBO_2 and H_2 to produce NaBH_4 because of the generated Al_2O_3 . However, if NaBO_2 was exchanged to $\text{Na}_4\text{B}_2\text{O}_5$, the regeneration would succeed at 400 °C and 2.3 MPa pressure of hydrogen.

3. NaBH_4 Regeneration via using $\text{NaBO}_2 \cdot x\text{H}_2\text{O}$ as Raw Materials

In NaBH_4 regeneration, many studies have focused on anhydrous NaBO_2 reducing. However, it should be noted that the direct hydrolysis byproduct is hydrated NaBO_2 . For the NaBH_4 aqueous solution hydrolysis, the byproduct is $\text{NaBO}_2 \cdot 4\text{H}_2\text{O}$ [75], while for the solid NaBH_4 hydrolysis, the byproduct is $\text{NaBO}_2 \cdot 2\text{H}_2\text{O}$. Anhydrous NaBO_2 should be produced by drying hydrated NaBO_2 at 350 °C. If the drying process was omitted, more energy could be saved and the price can be lowered. The energy of the hydrated NaBO_2 and anhydrous NaBO_2 is shown in Scheme 2. Some studies thus worked on reducing hydrated NaBO_2 directly.



Scheme 2. Schematic energy diagram of the boron material for the recycling of NaBO_2 to NaBH_4 , $\text{NaBO}_2 \cdot 2\text{H}_2\text{O}$ to NaBH_4 , and $\text{NaBO}_2 \cdot 4\text{H}_2\text{O}$ to NaBH_4 .

3.1. NaBH_4 Regeneration via the Reaction between MgH_2 and $\text{NaBO}_2 \cdot x\text{H}_2\text{O}$

For directly using hydrated NaBO_2 as the regeneration raw material, a thermochemistry method was tried. Liu et al. [76] reported that NaBH_4 can be regenerated by annealing Mg and $\text{NaBO}_2 \cdot 2\text{H}_2\text{O}$ under hydrogen atmosphere with only 12.3% yield. The low NaBH_4 yield may result from the obstruction of the thick generated MgO layer. However, they found that the coordinate water in $\text{NaBO}_2 \cdot 2\text{H}_2\text{O}$ was likely to be the hydrogen source. Considering the generated oxide layer, ball milling might be suitable to break the layer and continue the reaction. Therefore, we tried to use $\text{NaBO}_2 \cdot 4\text{H}_2\text{O}$ or $\text{NaBO}_2 \cdot 2\text{H}_2\text{O}$ to react with MgH_2 directly via ball milling to regenerate NaBH_4 [77]. NaBH_4 was successfully regenerated (Figure 1b):

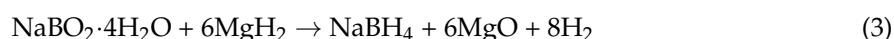
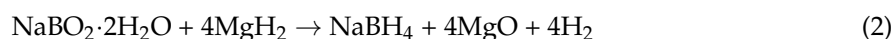

The energy efficiency calculated in Section 2 could be improved by approximately 5.2%. Furthermore, a high NaBH_4 yield of 89.78% was achieved by this method, which is the highest compared with previous studies [67,69,78].

3.2. NaBH_4 Regeneration via the Reaction between Mg and $\text{NaBO}_2 \cdot x\text{H}_2\text{O}$

Hydrated NaBO_2 could be directly used in NaBH_4 regeneration, saving the energy consumption on the dehydration to produce anhydrous NaBO_2 . However, production of MgH_2 from Mg requires high temperature to overcome the sluggish hydrogenation kinetics, resulting in the increased cost. In other words, the energy efficiency could be further promoted and the regeneration cost could be reduced, if the high-temperature hydrogenation process to produce MgH_2 can be avoided. According to Liu et al. [76], H in $\text{NaBO}_2 \cdot 2\text{H}_2\text{O}$ could transform to be the H of the regenerated NaBH_4 . As a result, directly reacting Mg with hydrated NaBO_2 was possible to regenerate NaBH_4 and avoided the high-temperature hydrogenation process. We found that NaBH_4 could be produced by ball milling the $\text{NaBO}_2 \cdot 2\text{H}_2\text{O}$ and Mg mixture under argon (Figure 1c) [79] according to:

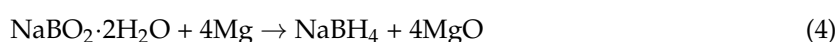

It should be noted that the regenerated H of NaBH_4 was completely from the coordinate water. On the other hand, the reaction between $\text{NaBO}_2 \cdot 4\text{H}_2\text{O}$ and Mg could also generate NaBH_4 by ball milling:



Currently, the highest NaBH₄ yield of the reaction between Mg and NaBO₂·2H₂O is only 68.55%. The energy efficiency needs to be further promoted. Note that the cost of this method is 34-fold lower than the method using MgH₂ and NaBO₂ in terms of the raw materials required [79].

3.3. NaBH₄ Regeneration via the Reaction between Mg₂Si and NaBO₂·2H₂O

Via ball milling hydrated NaBO₂ and Mg, NaBH₄ was regenerated and the energy efficiency was further increased. However, the highest NaBH₄ yield by this method was 68.55%, which did not reach the general yield of regenerated NaBH₄ (~76%) [67,68]. According to Kojima et al. [66], with Si added, the NaBH₄ yield was increased in the reaction between NaBO₂ and Mg under a hydrogen atmosphere. Therefore, Mg₂Si is possible to react with NaBO₂·2H₂O to regenerate NaBH₄ and improve the NaBH₄ yield. We have attempted the above idea in our previous study [80] and found that NaBH₄ was regenerated (Figure 1d) according to:

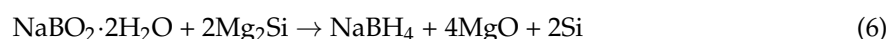

The highest NaBH₄ yield was increased to 78% when the Mg₂Si and NaBO₂·2H₂O mixture was ball milled for 20 h. By using Mg₂Si as a reducing agent, the NaBH₄ yield was promoted and the H was still from the coordinate water in NaBO₂·2H₂O. For the raw materials cost, this method is half of the commercial method and about 30-fold lower than the method using MgH₂ and NaBO₂ [80].

4. Mechanism of NaBH₄ Regeneration Using NaBO₂·xH₂O as Raw Materials

The above three works [77,79,80] are new discoveries for direct regeneration of NaBH₄ from the hydrated NaBO₂ with high yield. Some common points were found in their mechanism studies. In all of the three works, a resonance at approximately −11.4 ppm was observed in the NMR spectra (Figure 2), which belongs to intermediate [BH₃(OH)][−] [81]. Such an intermediate was likely to generate from [BH(OH)₃][−] and [BH₂(OH)₂][−]. Conjecturing from the above intermediates, [BH₄][−] was likely to generate from a step-by-step substitution process of [OH][−] in [B(OH)₄][−] by [H][−]. The [H]⁺ in NaBO₂·xH₂O thus transformed to [H][−] in this process.

For the reaction between MgH₂ and NaBO₂·2H₂O, the hydrogen transformation was realized by the substitution of the [OH][−] in NaBO₂·xH₂O by [H][−] in MgH₂. For the reaction of Mg and NaBO₂·2H₂O, Mg(OH)₂ and MgH₂ were generated as intermediates and the reactions can be written as:

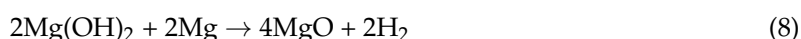
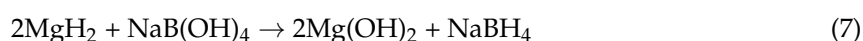

Since four moles of MgO were generated in this reaction (Equation (4)), it was a strong exergonic reaction. The reaction could be described as a substitution process of [OH][−] through the [H][−] from the produced intermediate MgH₂. During the substitution process, a side reaction may happen. [B₃H₈][−] was generated and then may react with MgH₂ and Na⁺ to form another part of NaBH₄ [82]. In the reaction between Mg₂Si and NaBO₂·2H₂O, Si–H was found (Figure 2d). It was speculated that an intermediate consisting of Mg, O, Si, and H was generated. The [OH][−] was transformed to [H][−] through a Mg–O–Si–H intermediate. Therefore, though Si was generated with an elemental state after the reaction, Si played an important role in H[−] formation. Consequently, the substitution process of [OH][−] through [H][−] was a direct process.

In conclusion, two forms of hydrogen molecules exist in the regeneration. They are H in [OH][−] and H in [H][−]. When using MgH₂ as a reducing agent, H in MgH₂ directly substitutes [OH][−] in NaB(OH)₄. This direct process contributes to the high NaBH₄ yield. In the situation of Mg, H in [OH][−] first transfer to H in MgH₂. Then it substitutes the [OH][−] in NaB(OH)₄ to form NaBH₄. The two-step reaction reduces the NaBH₄ yield. For the reaction between Mg₂Si and NaBO₂·2H₂O, H in [OH][−]

first transfers to H in Si–H and then it transfers to NaBH₄. Although this process is also two steps, the more active Si–H benefits from the higher NaBH₄ yield. Therefore, all of the reactions are H transfer processes.

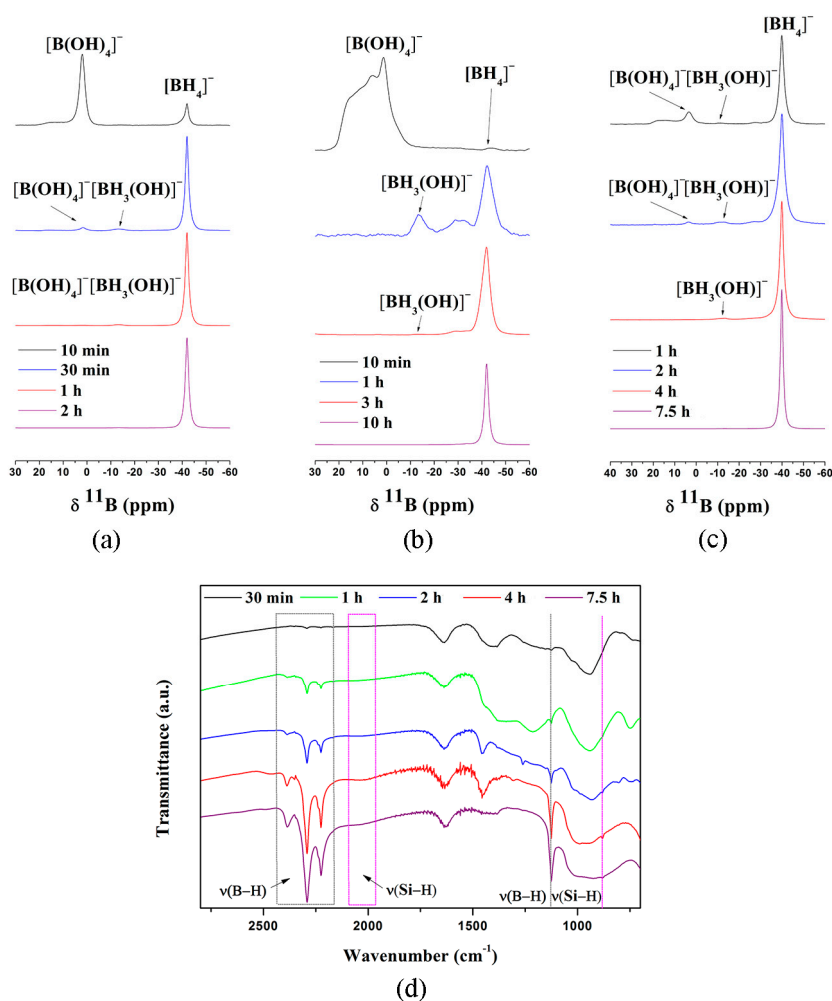

Figure 2. (a) Solid-state ¹¹B NMR spectra of products after ball milling MgH₂ and NaBO₂·2H₂O mixtures (in 5.0:1 mol ratio). (b) Solid-state ¹¹B NMR spectra of products after ball milling Mg and NaBO₂·2H₂O mixtures (in 5.0:1 mole ratio). (c) ¹¹B MAS NMR spectra of the products after ball milling Mg₂Si and NaBO₂·2H₂O mixtures (in 2:1 mol ratio). (d) FT-IR spectra of the products after ball milling Mg₂Si and NaBO₂·2H₂O mixtures (in 2:1 mol ratio).

5. Hydrolysis Property of Regenerated NaBH₄ Using NaBO₂·xH₂O as Raw Materials

Hydrolysis is the main application of the regenerated NaBH₄. By the catalysis of CoCl₂ [83], NaBH₄ could fast hydrolyze with stoichiometry H₂O. It was found that the regenerated NaBH₄ from NaBO₂·xH₂O had an excellent hydrolysis property, which was similar to the commercial NaBH₄. According to Figure 3, the highest system hydrogen capacity (containing water and catalyst) was 6.75 wt %, which was the highest compared with previous studies [67,69,78]. It was produced by the reaction between MgH₂ and NaBO₂·xH₂O. A system hydrogen capacity of 6.33 wt % and 6.3 wt % could also be obtained. Furthermore, the hydrolysis byproduct was indexed to be NaBO₂·2H₂O (inset, Figure 3), which was the raw material of our regeneration. As a result, it was demonstrated that a complete cycle of NaBH₄ hydrolysis could be achieved by existing works, which was suitable for sustainable application.

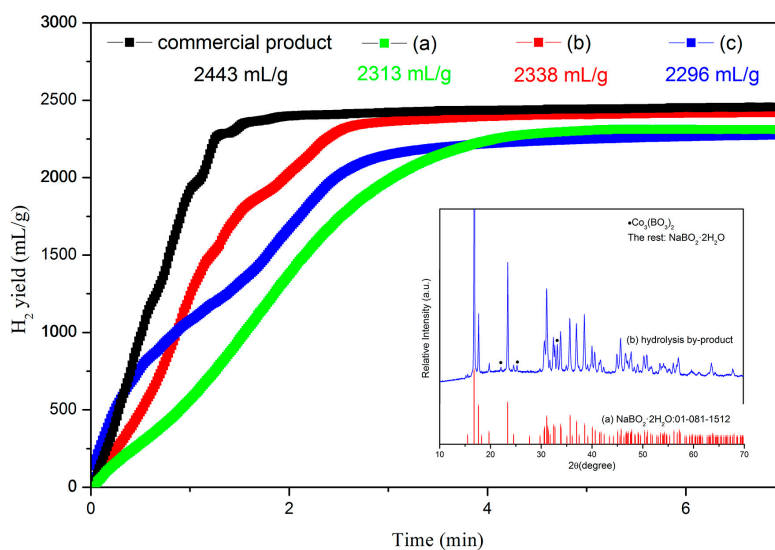

Figure 3. Hydrolysis curves of (a) the regeneration product (MgH_2 and $\text{NaBO}_2 \cdot x\text{H}_2\text{O}$). (b) The regeneration product (Mg and $\text{NaBO}_2 \cdot x\text{H}_2\text{O}$). (c) The purified product (Mg_2Si and $\text{NaBO}_2 \cdot 2\text{H}_2\text{O}$) and the commercial NaBH_4 in 5 wt % CoCl_2 aqueous solution. Inset: XRD patterns of (a) a standard PDF card of $\text{NaBO}_2 \cdot 2\text{H}_2\text{O}$ and (b) the hydrolysis byproduct.

6. Summary and Perspective

Application of NaBH_4 hydrolysis is limited by its effective regeneration. NaBH_4 synthesis and regeneration thus become attractive research topics, especially for the recycling of byproduct NaBO_2 . For the anhydrous NaBO_2 recycling, MgH_2 has the best reducing result. However, its high cost, resulting from the high hydrogenation temperature of Mg , limits the application of such methods. For the hydrolysis byproduct hydrated NaBO_2 , it can also be reduced by MgH_2 , Mg , or Mg_2Si via ball milling, and the highest NaBH_4 yield reaches 90%. This process using hydrated NaBO_2 exhibits significant advantages, whereby the dehydration process at 350°C to obtain anhydrous NaBO_2 can be omitted and, more importantly, the water included can react with chemicals like Mg and Mg_2Si to provide hydrogen instead of using MgH_2 . As a result, low cost metal (such as Mg , Ca , or Al) becomes possible to be the reducing agent for the NaBH_4 regeneration reaction via ball milling, because the $[\text{H}]^+$ in the hydrated NaBO_2 may directly transform to the $[\text{H}]^-$ in the hydrated NaBH_4 . These reactions could operate without extra hydrogen inputs, which provides the possibility of a low-cost and sustainable regeneration. Furthermore, this strategy may also be promoted to other areas, such as LiBH_4 production.

Acknowledgments: This work was supported by the Fund for Innovative Research Groups of the National Natural Science Foundation of China (no. NSFC51621001), the National Natural Science Foundation of China Projects (nos. 51431001 and 51771075), and by the Project Supported by Natural Science Foundation of Guangdong Province of China (nos. 2016A030312011 and 2014A030311004). The Project Supported by Guangdong Province Universities and Colleges Pearl River Scholar Funded Scheme (2014) is also acknowledged.

Conflicts of Interest: The authors declare no conflict of interest.

References

- Zhang, X.; Wei, Z.; Guo, Q.; Tian, H. Kinetics of sodium borohydride hydrolysis catalyzed via carbon nanosheets supported Zr/Co . *J. Power Sources* **2013**, *231*, 190–196. [[CrossRef](#)]
- Awad, A.S.; El-Asmar, E.; Tayeh, T.; Mauvy, F.; Nakhil, M.; Zakhour, M.; Bobet, J.L. Effect of carbons (G and CFs), TM (Ni, Fe and Al) and oxides (Nb_2O_5 and V_2O_5) on hydrogen generation from ball milled Mg -based hydrolysis reaction for fuel cell. *Energy* **2016**, *95*, 175–186. [[CrossRef](#)]

3. Brack, P.; Dann, S.E.; Wijyantha, K.G.U. Heterogeneous and homogenous catalysts for hydrogen generation by hydrolysis of aqueous sodium borohydride (NaBH_4) solutions. *Energy Sci. Eng.* **2015**, *3*, 174–188. [[CrossRef](#)]
4. Luo, Y.-C.; Liu, Y.-H.; Hung, Y.; Liu, X.-Y.; Mou, C.-Y. Mesoporous silica supported cobalt catalysts for hydrogen generation in hydrolysis of ammonia borane. *Int. J. Hydrog. Energy* **2013**, *38*, 7280–7290. [[CrossRef](#)]
5. Ding, Q.; Meng, F.; English, C.R.; Cabán-Acevedo, M.; Shearer, M.J.; Liang, D.; Daniel, A.S.; Hamers, R.J.; Jin, S. Efficient photoelectrochemical hydrogen generation using heterostructures of Si and chemically exfoliated metallic MoS_2 . *J. Am. Chem. Soc.* **2014**, *136*, 8504–8507. [[CrossRef](#)] [[PubMed](#)]
6. Ladomenou, K.; Natali, M.; Iengo, E.; Charalampidis, G.; Scandola, F.; Coutsolelos, A.G. Photochemical hydrogen generation with porphyrin-based systems. *Coord. Chem. Rev.* **2015**, *304*, 38–54. [[CrossRef](#)]
7. Huang, M.; Ouyang, L.; Wang, H.; Liu, J.; Zhu, M. Hydrogen generation by hydrolysis of MgH_2 and enhanced kinetics performance of ammonium chloride introducing. *Int. J. Hydrog. Energy* **2015**, *40*, 6145–6150. [[CrossRef](#)]
8. Bulut, A.; Yurderi, M.; Ertas, İ.E.; Celebi, M.; Kaya, M.; Zahmakiran, M. Carbon dispersed copper-cobalt alloy nanoparticles: A cost-effective heterogeneous catalyst with exceptional performance in the hydrolytic dehydrogenation of ammonia-borane. *Appl. Catal. B* **2016**, *180*, 121–129. [[CrossRef](#)]
9. Dudoladov, A.O.; Buryakovskaya, O.A.; Vlaskin, M.S.; Zhuk, A.Z.; Shkolnikov, E.I. Generation of hydrogen by aluminium oxidation in aqueous solutions at low temperatures. *Int. J. Hydrog. Energy* **2016**, *41*, 2230–2237. [[CrossRef](#)]
10. Huynh, K.; Napolitano, K.; Wang, R.; Jessop, P.G.; Davis, B.R. Indirect hydrolysis of sodium borohydride: Isolation and crystallographic characterization of methanolysis and hydrolysis by-products. *Int. J. Hydrog. Energy* **2013**, *38*, 5775–5782. [[CrossRef](#)]
11. Jiang, J.; Materna, K.L.; Hedström, S.; Yang, K.R.; Crabtree, R.H.; Batista, V.S.; Brudvig, G.W. Antimony Complexes for Electrocatalysis: Activity of a Main-Group Element in Proton Reduction. *Angew. Chem. Int. Ed.* **2017**, *56*, 9111–9115. [[CrossRef](#)] [[PubMed](#)]
12. Yilmaz, C.; Kanoglu, M. Thermodynamic evaluation of geothermal energy powered hydrogen production by PEM water electrolysis. *Energy* **2014**, *69*, 592–602. [[CrossRef](#)]
13. Wang, M.; Wang, Z.; Gong, X.; Guo, Z. The intensification technologies to water electrolysis for hydrogen production—A review. *Renew. Sustain. Energy Rev.* **2014**, *29*, 573–588. [[CrossRef](#)]
14. Cardoso, D.S.P.; Amaral, L.; Santos, D.M.F.; Šljukić, B.; Sequeira, C.A.C.; Macciò, D.; Saccone, A. Enhancement of hydrogen evolution in alkaline water electrolysis by using nickel-rare earth alloys. *Int. J. Hydrog. Energy* **2015**, *40*, 4295–4302. [[CrossRef](#)]
15. Kibria, M.G.; Qiao, R.; Yang, W.; Boukahil, I.; Kong, X.; Chowdhury, F.A.; Trudeau, M.L.; Ji, W.; Guo, H.; Himpfel, F.J.; et al. Atomic-Scale Origin of Long-Term Stability and High Performance of *p*-GaN Nanowire Arrays for Photocatalytic Overall Pure Water Splitting. *Adv. Mater.* **2016**, *28*, 8388–8397. [[CrossRef](#)] [[PubMed](#)]
16. Ma, G.; Chen, S.; Kuang, Y.; Akiyama, S.; Hisatomi, T.; Nakabayashi, M.; Shibata, N.; Katayama, M.; Minegishi, T.; Domen, K. Visible light-driven Z-scheme water splitting using oxysulfide H_2 evolution photocatalysts. *J. Phys. Chem. Lett.* **2016**, *7*, 3892–3896. [[CrossRef](#)] [[PubMed](#)]
17. Senthil, V.; Badapanda, T.; Chithambararaj, A.; Chandra Bose, A.; Panigrahi, S. Impedance spectroscopy and photocatalysis water splitting for hydrogen production with cerium modified $\text{SrBi}_2\text{Ta}_2\text{O}_9$ ferroelectrics. *Int. J. Hydrog. Energy* **2016**, *41*, 22856–22865. [[CrossRef](#)]
18. Gao, L.; Li, Y.; Ren, J.; Wang, S.; Wang, R.; Fu, G.; Hu, Y. Passivation of defect states in anatase TiO_2 hollow spheres with Mg doping: Realizing efficient photocatalytic overall water splitting. *Appl. Catal. B* **2017**, *202*, 127–133. [[CrossRef](#)]
19. Schlapbach, L.; Züttel, A. Hydrogen-storage materials for mobile applications. *Nature* **2001**, *414*, 353–358. [[CrossRef](#)] [[PubMed](#)]
20. Principi, G.; Agresti, F.; Maddalena, A.; Lo Russo, S. The problem of solid state hydrogen storage. *Energy* **2009**, *34*, 2087–2091. [[CrossRef](#)]
21. Sakintuna, B.; Lamari-Darkrim, F.; Hirscher, M. Metal hydride materials for solid hydrogen storage: A review. *Int. J. Hydrog. Energy* **2007**, *32*, 1121–1140. [[CrossRef](#)]
22. Lim, K.L.; Kazemian, H.; Yaakob, Z.; Daud, W.R.W. Solid-state Materials and Methods for Hydrogen Storage: A Critical Review. *Chem. Eng. Technol.* **2010**, *33*, 213–226. [[CrossRef](#)]
23. Khafidz, N.Z.A.K.; Yaakob, Z.; Lim, K.L.; Timmiati, S.N. The kinetics of lightweight solid-state hydrogen storage materials: A review. *Int. J. Hydrog. Energy* **2016**, *41*, 13131–13151. [[CrossRef](#)]

24. Amendola, S.C.; Sharp-Goldman, S.L.; Janjua, M.S.; Kelly, M.T.; Petillo, P.J.; Binder, M. An ultrasafe hydrogen generator: Aqueous, alkaline borohydride solutions and Ru catalyst. *J. Power Sources* **2000**, *85*, 186–189. [[CrossRef](#)]
25. Cao, N.; Hu, K.; Luo, W.; Cheng, G. RuCu nanoparticles supported on graphene: A highly efficient catalyst for hydrolysis of ammonia borane. *J. Alloys Compd.* **2014**, *590*, 241–246. [[CrossRef](#)]
26. Ouyang, L.Z.; Dong, H.W.; Peng, C.H.; Sun, L.X.; Zhu, M. A new type of Mg-based metal hydride with promising hydrogen storage properties. *Int. J. Hydrog. Energy* **2007**, *32*, 3929–3935. [[CrossRef](#)]
27. Liu, Y.; Du, H.; Zhang, X.; Yang, Y.; Gao, M.; Pan, H. Superior catalytic activity derived from a two-dimensional Ti₃C₂ precursor towards the hydrogen storage reaction of magnesium hydride. *Chem. Commun.* **2016**, *52*, 705–708. [[CrossRef](#)] [[PubMed](#)]
28. Ouyang, L.Z.; Cao, Z.J.; Wang, H.; Liu, J.W.; Sun, D.L.; Zhang, Q.A.; Zhu, M. Enhanced dehydrogenation thermodynamics and kinetics in Mg(In)–MgF₂ composite directly synthesized by plasma milling. *J. Alloys Compd.* **2014**, *586*, 113–117. [[CrossRef](#)]
29. Ouyang, L.Z.; Huang, J.M.; Fang, C.J.; Zhang, Q.A.; Sun, D.L.; Zhu, M. The controllable hydrolysis rate for LaMg₁₂ hydride. *Int. J. Hydrog. Energy* **2012**, *37*, 12358–12364. [[CrossRef](#)]
30. Ouyang, L.; Ma, M.; Huang, M.; Duan, R.; Wang, H.; Sun, L.; Zhu, M. Enhanced Hydrogen Generation Properties of MgH₂-Based Hydrides by Breaking the Magnesium Hydroxide Passivation Layer. *Energies* **2015**, *8*, 4237–4252. [[CrossRef](#)]
31. Varin, R.A.; Jang, M.; Czujko, T.; Wronski, Z.S. The effect of ball milling under hydrogen and argon on the desorption properties of MgH₂ covered with a layer of Mg(OH)₂. *J. Alloys Compd.* **2010**, *493*, L29–L32. [[CrossRef](#)]
32. Kadri, A.; Jia, Y.; Chen, Z.; Yao, X. Catalytically Enhanced Hydrogen Sorption in Mg–MgH₂ by Coupling Vanadium-Based Catalyst and Carbon Nanotubes. *Materials* **2015**, *8*, 3491–3507. [[CrossRef](#)]
33. Hiraki, T.; Hiroi, S.; Akashi, T.; Okinaka, N.; Akiyama, T. Chemical equilibrium analysis for hydrolysis of magnesium hydride to generate hydrogen. *Int. J. Hydrog. Energy* **2012**, *37*, 12114–12119. [[CrossRef](#)]
34. Tayeh, T.; Awad, A.S.; Nakhil, M.; Zakhour, M.; Silvain, J.F.; Bobet, J.L. Production of hydrogen from magnesium hydrides hydrolysis. *Int. J. Hydrog. Energy* **2014**, *39*, 3109–3117. [[CrossRef](#)]
35. Fernandes, R.; Patel, N.; Paris, A.; Calliari, L.; Miotello, A. Improved H₂ production rate by hydrolysis of Ammonia Borane using quaternary alloy catalysts. *Int. J. Hydrog. Energy* **2013**, *38*, 3313–3322. [[CrossRef](#)]
36. Kantürk Figen, A.; Coşkun, B. A novel perspective for hydrogen generation from ammonia borane (NH₃BH₃) with Co–B catalysts: “Ultrasonic Hydrolysis”. *Int. J. Hydrog. Energy* **2013**, *38*, 2824–2835. [[CrossRef](#)]
37. Rakap, M. PVP-stabilized Ru–Rh nanoparticles as highly efficient catalysts for hydrogen generation from hydrolysis of ammonia borane. *J. Alloys Compd.* **2015**, *649*, 1025–1030. [[CrossRef](#)]
38. Yang, X.J.; Li, L.L.; Sang, W.L.; Zhao, J.L.; Wang, X.X.; Yu, C.; Zhang, X.H.; Tang, C.C. Boron nitride supported Ni nanoparticles as catalysts for hydrogen generation from hydrolysis of ammonia borane. *J. Alloys Compd.* **2017**, *693*, 642–649. [[CrossRef](#)]
39. Durak, H.; Gulcan, M.; Zahmakiran, M.; Ozkar, S.; Kaya, M. Hydroxyapatite-nanosphere supported ruthenium(0) nanoparticle catalyst for hydrogen generation from ammonia-borane solution: Kinetic studies for nanoparticle formation and hydrogen evolution. *Rsc. Adv.* **2014**, *4*, 28947–28955. [[CrossRef](#)]
40. Garralda, M.A.; Mendicuti-Fierro, C.; Rodriguez-Dieguez, A.; Seco, J.M.; Ubide, C.; Zumeta, I. Efficient hydridoirida-beta-diketone-catalyzed hydrolysis of ammonia- or amine-boranes for hydrogen generation in air. *Dalton Trans.* **2013**, *42*, 11652–11660. [[CrossRef](#)] [[PubMed](#)]
41. Barakat, N.A.M. Catalytic and photo hydrolysis of ammonia borane complex using Pd-doped Co nanofibers. *Appl. Catal. A* **2013**, *451*, 21–27. [[CrossRef](#)]
42. Jiang, H.-L.; Xu, Q. Catalytic hydrolysis of ammonia borane for chemical hydrogen storage. *Catal. Today* **2011**, *170*, 56–63. [[CrossRef](#)]
43. Li, H.; Yang, Q.; Chen, X.; Shore, S.G. Ammonia borane, past as prolog. *J. Organomet. Chem.* **2014**, *751*, 60–66. [[CrossRef](#)]
44. Summerscales, O.T.; Gordon, J.C. Regeneration of ammonia borane from spent fuel materials. *Dalton Trans.* **2013**, *42*, 10075–10084. [[CrossRef](#)] [[PubMed](#)]
45. Sutton, A.D.; Davis, B.L.; Bhattacharyya, K.X.; Ellis, B.D.; Gordon, J.C.; Power, P.P. Recycle of tin thiolate compounds relevant to ammonia-borane regeneration. *Chem. Commun.* **2010**, *46*, 148–149. [[CrossRef](#)] [[PubMed](#)]

46. Zhou, Y.; Fang, C.; Fang, Y.; Zhu, F.; Liu, H.; Ge, H. Hydrogen generation mechanism of spontaneous hydrolysis: A sight from ab initio calculation. *Int. J. Hydrog. Energy* **2016**, *41*, 22668–22676. [CrossRef]
47. Retnamma, R.; Novais, A.Q.; Rangel, C.M. Kinetics of hydrolysis of sodium borohydride for hydrogen production in fuel cell applications: A review. *Int. J. Hydrog. Energy* **2011**, *36*, 9772–9790. [CrossRef]
48. Zhong, H.; Wang, H.; Liu, J.W.; Sun, D.L.; Fang, F.; Zhang, Q.A.; Ouyang, L.Z.; Zhu, M. Enhanced hydrolysis properties and energy efficiency of MgH₂-base hydrides. *J. Alloys Compd.* **2016**, *680*, 419–426. [CrossRef]
49. Nunes, H.X.; Ferreira, M.J.F.; Rangel, C.M.; Pinto, A.M.F.R. Hydrogen generation and storage by aqueous sodium borohydride (NaBH₄) hydrolysis for small portable fuel cells (H₂ – PEMFC). *Int. J. Hydrog. Energy* **2016**, *41*, 15426–15432. [CrossRef]
50. Chinnappan, A.; Puguan, J.M.C.; Chung, W.-J.; Kim, H. Hydrogen generation from the hydrolysis of sodium borohydride using chemically modified multiwalled carbon nanotubes with pyridinium based ionic liquid and decorated with highly dispersed Mn nanoparticles. *J. Power Sources* **2015**, *293*, 429–436. [CrossRef]
51. Lin, K.-Y.A.; Chang, H.-A. Efficient hydrogen production from NaBH₄ hydrolysis catalyzed by a magnetic cobalt/carbon composite derived from a zeolitic imidazolate framework. *Chem. Eng. J.* **2016**, *296*, 243–251. [CrossRef]
52. Demirci, U.B.; Miele, P. Cobalt in NaBH₄ hydrolysis. *Phys. Chem. Chem. Phys.* **2010**, *12*, 14651–14665. [CrossRef] [PubMed]
53. Zhu, J.; Li, R.; Niu, W.; Wu, Y.; Gou, X. Fast hydrogen generation from NaBH₄ hydrolysis catalyzed by carbon aerogels supported cobalt nanoparticles. *Int. J. Hydrog. Energy* **2013**, *38*, 10864–10870. [CrossRef]
54. Wang, M.C.; Ouyang, L.Z.; Liu, J.W.; Wang, H.; Zhu, M. Hydrogen generation from sodium borohydride hydrolysis accelerated by zinc chloride without catalyst: A kinetic study. *J. Alloys Compd.* **2017**, *717*, 48–54. [CrossRef]
55. Program, U.S.D.o.E.H. Go/No-Go Recommendation for Sodium Borohydride for On-Board Vehicular Hydrogen Storage. Available online: <http://www.hydrogen.energy.gov/pdfs/42220.pdf> (accessed on 1 July 2017).
56. Demirci, U.B.; Akdim, O.; Miele, P. Ten-year efforts and a no-go recommendation for sodium borohydride for on-board automotive hydrogen storage. *Int. J. Hydrog. Energy* **2009**, *34*, 2638–2645. [CrossRef]
57. Schlesinger, H.I.; Brown, H.C.; Finholt, A.E. The Preparation of Sodium Borohydride by the High Temperature Reaction of Sodium Hydride with Borate Esters¹. *J. Am. Chem. Soc.* **1953**, *75*, 205–209. [CrossRef]
58. Johnson, W.C.; Isenberg, S. Hydrogen Compounds of Silicon. I. The Preparation of Mono- and Disilane. *J. Am. Chem. Soc.* **1935**, *57*, 1349–1353. [CrossRef]
59. Li, Z.P.; Morigazaki, N.; Liu, B.H.; Suda, S. Preparation of sodium borohydride by the reaction of MgH₂ with dehydrated borax through ball milling at room temperature. *J. Alloys Compd.* **2003**, *349*, 232–236. [CrossRef]
60. Çakanyıldırım, Ç.; Gürü, M. The Production of NaBH₄ from Its Elements by Mechano-chemical Reaction and Usage in Hydrogen Recycle. *Energy Sources Part A* **2011**, *33*, 1912–1920. [CrossRef]
61. Bilen, M.; Gürü, M.; Çakanyıldırım, Ç. Role of NaCl in NaBH₄ production and its hydrolysis. *Energy Convers. Manag.* **2013**, *72*, 134–140. [CrossRef]
62. Marrero-Alfonso, E.Y.; Gray, J.R.; Davis, T.A.; Matthews, M.A. Minimizing water utilization in hydrolysis of sodium borohydride: The role of sodium metaborate hydrates. *Int. J. Hydrog. Energy* **2007**, *32*, 4723–4730. [CrossRef]
63. Ved, A.S.; Miley, G.H.; Seetaraman, T.S. Recycling Sodium Metaborate to Sodium Borohydride Using Wind-Solar Energy System for Direct Borohydride Fuel Cell. In Proceedings of the ASME 2010 8th International Fuel Cell Science, Engineering and Technology, Brooklyn, NY, USA, 14–16 June 2010; pp. 139–141.
64. Sanli, A.E.; Kayacan, İ.; Uysal, B.Z.; Aksu, M.L. Recovery of borohydride from metaborate solution using a silver catalyst for application of direct rechargeable borohydride/peroxide fuel cells. *J. Power Sources* **2010**, *195*, 2604–2607. [CrossRef]
65. McLafferty, J.; Colominas, S.; Macdonald, D.D. Attempts to cathodically reduce boron oxides to borohydride in aqueous solution. *Electrochim. Acta* **2010**, *56*, 108–114. [CrossRef]
66. Kojima, Y.; Haga, T. Recycling process of sodium metaborate to sodium borohydride. *Int. J. Hydrog. Energy* **2003**, *28*, 989–993. [CrossRef]
67. Hsueh, C.-L.; Liu, C.-H.; Chen, B.-H.; Chen, C.-Y.; Kuo, Y.-C.; Hwang, K.-J.; Ku, J.-R. Regeneration of spent-NaBH₄ back to NaBH₄ by using high-energy ball milling. *Int. J. Hydrog. Energy* **2009**, *34*, 1717–1725. [CrossRef]

68. Kong, L.; Cui, X.; Jin, H.; Wu, J.; Du, H.; Xiong, T. Mechanochemical Synthesis of Sodium Borohydride by Recycling Sodium Metaborate. *Energy Fuels* **2009**, *23*, 5049–5054. [[CrossRef](#)]
69. Çakanyıldırım, Ç.; Gürü, M. Processing of NaBH₄ from NaBO₂ with MgH₂ by ball milling and usage as hydrogen carrier. *Renew. Energy* **2010**, *35*, 1895–1899. [[CrossRef](#)]
70. Ouyang, L.Z.; Zhong, H.; Li, Z.M.; Cao, Z.J.; Wang, H.; Liu, J.W.; Zhu, X.K.; Zhu, M. Low-cost method for sodium borohydride regeneration and the energy efficiency of its hydrolysis and regeneration process. *J. Power Sources* **2014**, *269*, 768–772. [[CrossRef](#)]
71. Lang, C.; Jia, Y.; Liu, J.; Wang, H.; Ouyang, L.; Zhu, M.; Yao, X. NaBH₄ regeneration from NaBO₂ by high-energy ball milling and its plausible mechanism. *Int. J. Hydrog. Energy* **2017**, *42*, 13127–13135. [[CrossRef](#)]
72. Liu, B. Kinetic characteristics of sodium borohydride formation when sodium meta-borate reacts with magnesium and hydrogen. *Int. J. Hydrog. Energy* **2008**, *33*, 1323–1328. [[CrossRef](#)]
73. Eom, K.; Cho, E.; Kim, M.; Oh, S.; Nam, S.-W.; Kwon, H. Thermochemical production of sodium borohydride from sodium metaborate in a scaled-up reactor. *Int. J. Hydrog. Energy* **2013**, *38*, 2804–2809. [[CrossRef](#)]
74. Liu, B.H.; Li, Z.P.; Zhu, J.K.; Morigasaki, N.; Suda, S. Sodium Borohydride Synthesis by Reaction of Na₂O Contained Sodium Borate with Al and Hydrogen. *Energy Fuels* **2007**, *21*, 1707–1711. [[CrossRef](#)]
75. Beaird, A.M.; Li, P.; Marsh, H.S.; Al-Saidi, W.A.; Johnson, J.K.; Matthews, M.A.; Williams, C.T. Thermal Dehydration and Vibrational Spectra of Hydrated Sodium Metaborates. *Ind. Eng. Chem. Res.* **2011**, *50*, 7746–7752. [[CrossRef](#)]
76. Liu, B.H.; Li, Z.P.; Zhu, J.K. Sodium borohydride formation when Mg reacts with hydrous sodium borates under hydrogen. *J. Alloys Compd.* **2009**, *476*, L16–L20. [[CrossRef](#)]
77. Chen, W.; Ouyang, L.Z.; Liu, J.W.; Yao, X.D.; Wang, H.; Liu, Z.W.; Zhu, M. Hydrolysis and regeneration of sodium borohydride (NaBH₄)—A combination of hydrogen production and storage. *J. Power Sources* **2017**, *359*, 400–407. [[CrossRef](#)]
78. Zhang, H.; Zheng, S.; Fang, F.; Chen, G.; Sang, G.; Sun, D. Synthesis of NaBH₄ based on a solid-state reaction under Ar atmosphere. *J. Alloys Compd.* **2009**, *484*, 352–355. [[CrossRef](#)]
79. Ouyang, L.; Chen, W.; Liu, J.; Felderhoff, M.; Wang, H.; Zhu, M. Enhancing the Regeneration Process of Consumed NaBH₄ for Hydrogen Storage. *Adv. Energy Mater.* **2017**, *7*, 1700299. [[CrossRef](#)]
80. Zhong, H.; Ouyang, L.Z.; Ye, J.S.; Liu, J.W.; Wang, H.; Yao, X.D.; Zhu, M. An one-step approach towards hydrogen production and storage through regeneration of NaBH₄. *Energy Storage Mater.* **2017**, *7*, 222–228. [[CrossRef](#)]
81. Andrieux, J.; Demirci, U.B.; Hannauer, J.; Gervais, C.; Goutaudier, C.; Miele, P. Spontaneous hydrolysis of sodium borohydride in harsh conditions. *Int. J. Hydrog. Energy* **2011**, *36*, 224–233. [[CrossRef](#)]
82. Chong, M.; Karkamkar, A.; Autrey, T.; Orimo, S.-I.; Jalisatgi, S.; Jensen, C.M. Reversible dehydrogenation of magnesium borohydride to magnesium triborane in the solid state under moderate conditions. *Chem. Commun.* **2011**, *47*, 1330–1332. [[CrossRef](#)] [[PubMed](#)]
83. Dai, H.-B.; Ma, G.-L.; Kang, X.-D.; Wang, P. Hydrogen generation from coupling reactions of sodium borohydride and aluminum powder with aqueous solution of cobalt chloride. *Catal. Today* **2011**, *170*, 50–55. [[CrossRef](#)]

