

## Article

# Leadership Energy Theory for Sustaining Leadership Competence and Effectiveness

Oluseye Olugboyega<sup>1</sup>, Obuks Ejohwomu<sup>2,\*</sup> , Emmanuel Dele Omopariola<sup>3,4</sup>  and Alohan Omoregie<sup>5</sup>

<sup>1</sup> Construction Engineering and Computational Modelling Research Group (CECM-RG), Department of Building, Construction Management Specialisation, Obafemi Awolowo University, Ile-Ife A234, Nigeria; oolugboyega@oauife.edu.ng

<sup>2</sup> Department of Mechanical, Aerospace and Civil Engineering, University of Manchester, Manchester M13 9PL, UK

<sup>3</sup> Department of Construction Economics and Management, University of Cape Town, Cape Town 7701, South Africa; felixdelly@yahoo.com

<sup>4</sup> Department of Building Technology, Kogi State Polytechnic, Lokoja 260102, Nigeria

<sup>5</sup> Faculty of Engineering and Science, University of Greenwich, London SE10 9LS, UK; a.omoregie@greenwich.ac.uk

\* Correspondence: obuks.ejohwomu@manchester.ac.uk

**Abstract:** Leaders who lack leadership energy may struggle to demonstrate sustained competence and achieve effectiveness in difficult leadership situations. This research investigates the sources of leadership energy and examines the impact of leadership energy on the development and sustainability of leadership effectiveness and competence. This study employed a hypothetico-deductive research design, wherein the formulated hypotheses were tested through structural equation modelling (SEM). Data were collected using a questionnaire survey. A total of 272 responses were received from leaders of various industries, indicating a response rate of 66%. The findings of this study indicate that a leader's capacity to respond to various situations, comprehend the importance of being directive, prioritize the development of positive attitudes and supportiveness, and recognize the significance of achievement are all factors that contribute to the internal mechanisms necessary for the leader's manifestation of leadership energy. The study additionally discovered that leaders' skills, qualities, and abilities are derived and maintained through their internal capacity and personal resilience emanating from their leadership energy. The hypotheses that were validated suggest a direct causal relationship, indicating that leadership motivation, leadership personality, and leadership orientation are significant factors in the generation of leadership energy. This study's conclusions suggest that to sustain leadership competence and effectiveness, leaders must cultivate a culture that prioritizes both effectiveness and competence. The findings also imply that individuals must establish precise developmental objectives, as well as exhibit cognizance of and the acquisition of leadership expertise, knowledge and approaches. Thus, the need to reevaluate the competency-based approach to leadership is overwhelming. This study introduces the concept of leadership energy as a catalyst for perpetuating leadership effectiveness and competence. The study claims that the energy emanating from the intricate interplay of leaders' orientation, experience, development, personality, and motivation engenders and perpetuates their efficacy and aptitude.

**Keywords:** leadership; leadership energy; leadership effectiveness; leadership competence; sustainable leadership; leadership theory



**Citation:** Olugboyega, O.; Ejohwomu, O.; Omopariola, E.D.; Omoregie, A. Leadership Energy Theory for Sustaining Leadership Competence and Effectiveness. *Merits* **2024**, *4*, 191–210. <https://doi.org/10.3390/merits4020014>

Academic Editor: Wendy M. Purcell

Received: 29 March 2024

Revised: 15 May 2024

Accepted: 28 May 2024

Published: 7 June 2024



**Copyright:** © 2024 by the authors. Licensee MDPI, Basel, Switzerland. This article is an open access article distributed under the terms and conditions of the Creative Commons Attribution (CC BY) license (<https://creativecommons.org/licenses/by/4.0/>).

## 1. Introduction

The significance of leaders' effectiveness and competence has been recognized as a crucial concept in leadership research, as it signifies the degree to which leaders effectively carry out their responsibilities and achieve the organization's objectives. Nevertheless, the

primary emphasis of prior investigations has largely revolved around identifying and evaluating factors that contribute to the efficacy and aptitude of leadership rather than delving into the mechanisms involved in their cultivation and perpetuation. Communication and motivation have been identified as key indicators of leadership effectiveness [1,2]. The key measures of leadership competence include goal framing, capacity building, defusing resistance and conflict, and institutionalizing [3]. Also, emotional intelligence can be measured to forecast the effectiveness of leadership [4–7].

The effectiveness of leadership is contingent upon the degree to which the leader embodies the group's identity and engages in behaviours that are perceived to be advantageous for the group [8,9]. Based on the research conducted by Dhar and Mishra in 2001, it has been determined that various factors contribute to the effectiveness of a leader. These factors encompass the leader's capacity to inspire, facilitate, motivate, and influence others, as well as to demonstrate accountability, maintain a positive attitude, and monitor the performance of their subordinates. A connection has been established between leadership competencies and transformational leadership styles [10–13]. The connection suggests that implementing a transformational leadership style can potentially enhance organizational commitment and job satisfaction.

These investigations have synthesized the accumulated knowledge and wisdom of experienced individuals in positions of leadership. Additionally, a comprehensive set of leadership behaviours and characteristics has been delineated, which serves to accurately depict and forecast the efficacy of leaders. The resulting collection serves as a valuable instrument for personal growth and development while also establishing a framework for the assessment, cultivation, and comprehension of leadership effectiveness and competence. Understanding the ability to forecast the efficacy and competence of leadership is of significance; however, it is of paramount importance to comprehend the means to engendering and sustaining leadership effectiveness and competence [14–16]. This is due to the fact that the attributes of leadership and the surrounding circumstances are subject to constant change and evolution [17]. Furthermore, it is of utmost significance to comprehend the mechanisms behind the generation and perpetuation of leadership effectiveness and competence, as the assurance of leadership competencies and effectiveness is contingent upon their ability to be generated.

The effectiveness and competence of leadership can be understood as a dynamic process rather than a static state. The effectiveness of leaders is contingent upon the intricate interplay between their orientation and the extent to which situational factors afford them opportunities to exert their influence. Generating these entities may be relatively straightforward; however, maintaining their existence over time is the challenge. Furthermore, it is conceivable that leaders may find it relatively effortless to demonstrate competence and achieve effectiveness under favourable circumstances. However, unless leaders possess an inexhaustible reserve of efficacy and competence, the task of exhibiting competence and attaining effectiveness in unfavourable leadership situations will prove challenging. The responsibility of a leader is not consistently facile. Various factors have been observed to exert an influence on the competencies and effectiveness of leadership. There will be periods of arduous and challenging circumstances. In times of adversity, the assurance of leadership competence and effectiveness is contingent upon leaders possessing a mechanism for mobilizing and sustaining their competence and effectiveness over a prolonged period. Therefore, it is imperative to comprehend the origin and the force that upholds the effectiveness and competence of leadership.

The underlying force that upholds the efficacy and competence of leadership surpasses the necessity for leadership competencies and effectiveness. This phenomenon can be identified as a manifestation of leadership energy as it pertains to the inner capability of and personal resilience exhibited by a leader [18–20]. Hence, this research endeavour seeks to explore the sources of leadership energy and scrutinize the role of leadership energy in engendering and perpetuating leadership effectiveness and competence. The primary aim of this study is to examine the correlation between the comprehension of leadership energy

sources and their impact on the generation and sustenance of leadership effectiveness and competence. The ultimate goal of this study is to develop a theory for effectively sustaining leadership effectiveness and competence.

## 2. Sources of Leadership Energy

Leadership energy is an interior strength, or the inner capability and personal resilience of a leader, that achieves its effect through outer mechanisms [18,20,21]. These outer mechanisms are not only responsible for providing the source of leadership energy, but they also have a significant impact on the amount of leadership energy and influence the ebb and flow of leadership energy. This study hypothesizes that the outer mechanisms through which leadership energy shows itself include leadership orientation, experience, development, personality, and motivation [18,22–24]. These are the five components that generate leadership energy. The way in which leaders evaluate situations, react to situations, and make judgements is referred to as their leadership orientation. It is a way for leaders to give meaning to their work. Leadership orientation has a strong and significant effect on innovative and proactive personalities [25,26]. It has been discovered that the importance that leaders place on leadership characteristics grows as they gain more experience in leadership roles [22]. This suggests that leadership orientation is not only important for individual leaders but also for the overall success and innovation within an organisation. As leaders gain more experience, they may begin to prioritise certain traits or qualities that align with their leadership orientation. This can ultimately shape the culture and direction of the organisation, influencing the behaviour and performance of employees. Overall, understanding and cultivating a strong leadership orientation can have a profound impact on both individual leaders and the organisations they lead.

The most important way to learn how to lead is through one's own personal experiences [27–29]. It was also found that training and other formal programmes play a very small role in leadership development compared to the role that experiential learning plays in the workplace. In fact, true leadership development happens through hands-on experience and learning from mistakes [27]. This implies that leaders must be willing to take risks, make decisions, and face challenges in order to grow and develop their leadership skills. By actively seeking out opportunities to lead and learning from their experiences, individuals can become more effective and impactful leaders within their organisations. Ultimately, leadership development is a continuous journey that requires dedication, self-reflection, and a willingness to adapt and grow. Leaders will be able to appropriately and constantly deal with organisational issues when they are required to go through extensive and systematic leadership development that is spread out over a significant amount of time [30]. This type of training should also span many years. Through long-term leadership development programmes, individuals can cultivate the necessary skills and knowledge to navigate complex organisational challenges with confidence and poise. By committing to ongoing learning and self-improvement, leaders can stay ahead of the curve and drive meaningful change within their teams and companies. A sustained and comprehensive approach to leadership development is essential for achieving long-term success and creating a lasting impact in the business world [30].

One of the factors that can influence the efficacy of a leader is the level of the leader's motivation [1]. Leaders gain an inner capability as a result of the complex leadership-related knowledge and abilities that are acquired from prior leadership experience [22]. This inner capability allows leaders to navigate challenges with confidence, make informed decisions, and inspire their teams to achieve greatness. By continuously investing in their own development and learning from past experiences, leaders can cultivate a strong foundation for success and make a positive impact on their organisations. In conclusion, effective leadership development is a multifaceted process that requires dedication, motivation, and a commitment to ongoing growth and improvement. This inner capability allows leaders to navigate challenging situations with confidence and resilience.

There is a strong connection between leadership personality (individual differences in leadership characteristics) and leadership emergence, perception, commitment, and effectiveness [31,32]. This suggests that a leader's distinctive traits and qualities have a significant impact on their capacity to emerge as a leader, how others perceive them, how committed they are to their position, and ultimately, how successful they are in leading their team or organization. By understanding and leveraging these individual differences, leaders can further enhance their leadership capabilities and drive success within their organisations. It is clear that effective leadership is not only about skills and knowledge but also about personal growth and self-awareness.

Thus, Hypothesis 1 posits that the flow of leadership energy emanates from various sources, namely leadership orientation (H1a), experience (H1b), development (H1c), personality (H1d), and motivation (H1e).

### *2.1. Role of Leadership Energy in Generating and Sustaining Leadership Effectiveness and Competence*

Leadership energy is both a starting point and a force that sustains leadership effectiveness and competency [20]. Individuals have a better understanding of their own and others' leadership capabilities as a result of the increased competence and effectiveness resulting from leadership energy. This heightened awareness allows individuals to make more informed decisions when it comes to leadership roles and responsibilities. As a result, teams are able to work more cohesively and efficiently, which ultimately leads to greater success and the achievement of organizational goals. In essence, leadership energy is the driving force behind effective leadership practices and is crucial for creating a positive and productive work environment.

Leaders who are capable and effective are able to accept some personal responsibility and take some independent action towards their own development. When it comes to teaching leaders how to assess and evaluate their own leadership performance, both effectiveness and competence are equally vital components. They significantly improved leaders' ability to evaluate employee performance in a variety of different organizations [5,10,17,33]. By focusing on developing these skills, leaders can more effectively provide feedback and support to their employees, ultimately leading to increased job satisfaction and performance. Furthermore, effective leaders who are able to accurately assess their own performance are better equipped to identify areas for improvement and continue to grow and develop. Overall, self-assessment plays a crucial role in the ongoing development of strong and successful leaders within any organisation. However, a leader's competence and effectiveness are not sufficient for them to maintain their efficacy because there are leadership constraints that inhibit a leader's continued and maintained effectiveness and competence [34]. As a result, the ability to sustain one's effectiveness and competence as a leader becomes important.

Also, it is important to address these leadership constraints in order to ensure that leaders are able to continuously improve and adapt in their role [34]. By recognising and overcoming these obstacles, leaders can strive towards sustained effectiveness and competence. This highlights the necessity for ongoing self-assessment and a commitment to personal growth in order to navigate the challenges and complexities of leadership successfully. Ultimately, it is through a combination of self-awareness, resilience, and a willingness to learn that leaders can overcome these constraints and continue to excel in their roles.

As a concept, "sustainable leadership effectiveness and competence" refer to the replenishing sources of leadership competence and effectiveness that enable leaders to keep their efficiency and influence at a high level while also expanding such capacities. Sustainable leadership effectiveness and competence make it possible for leaders to have a quick and resilient reaction that is also competitive, appealing, and reliable in all circumstances, notwithstanding the degree of complexity of the scenario [35]. Leaders who possess sustainable leadership effectiveness and competence are able to adapt to changing environments and challenges with ease. By continuously developing their skills and knowledge, these

leaders are able to navigate through uncertainty and drive their teams towards success. In today's fast-paced and dynamic world, sustainable leadership is crucial for organisations to stay ahead of the competition and achieve long-term success. Sustainable leadership effectiveness and competence create psychological resilience that enables leaders to flourish in spite of adverse circumstances [36]. By fostering a culture of continuous learning and growth within their organisations, sustainable leaders are able to inspire and motivate their teams to perform at their best. These leaders understand the importance of staying agile and adaptable in order to capitalise on opportunities and overcome obstacles. By embodying resilience and competence, sustainable leaders set the tone for their organisations to thrive in an ever-changing landscape.

Sustained leadership effectiveness and competency develop psychological resilience, which not only protects against burnout but also alleviates distress, enhances general well-being, and boosts engagement. Future organisational survival will depend heavily on the presence of leaders who are able to foster psychological resilience not just within themselves but also within their followers. Leaders who can demonstrate their ability to navigate challenges with grace and determination inspire confidence and trust among their teams. This trust creates a sense of security and stability within the organisation, enabling employees to feel supported and motivated to achieve their goals. As a result, sustainable leaders who prioritise psychological resilience contribute to a positive work culture that fosters innovation, collaboration, and ultimately, long-term success. In essence, the future of organisational success lies in the hands of leaders who understand the importance of building resilience in themselves and their teams.

In sum, Hypothesis 2 posits that the effectiveness (H2a) and competence (H2b) of leaders are derived from their leadership energy.

Hypothesis 3 posits that the psychological resilience of leaders is contingent upon their level of efficacy (H3a) and competence (H3b), which can be derived from their level of leadership energy.

## *2.2. Leadership Energy Theory for Sustainable Leadership Effectiveness and Competence*

Drawing upon the profound insight derived from theoretical underpinnings, this study posits the notion of leadership energy as a catalyst for the perpetuation of leadership effectiveness and competence. The postulates inherent in this particular theory are that the energy required to uphold leadership proficiency and efficacy can solely emanate from one's predisposition towards leadership, accumulated experience, personal growth, individual disposition, and inner drive. It is argued that individuals who possess a strong inclination towards leadership, combined with a drive for personal growth and continuous improvement, are more likely to exhibit high levels of leadership energy. This energy, in turn, fuels their ability to effectively lead and inspire others to achieve common goals. By focusing on developing and harnessing this leadership energy, individuals can enhance their overall leadership effectiveness and competence, ultimately leading to greater success in their leadership roles. Leadership energy, in essence, serves as the impetus that engenders and perpetuates the state of leadership effectiveness and competence. Moreover, the level of leadership energy exerts dominion over the perpetuity and uniformity of leadership effectiveness and competence. Leaders who are able to tap into their leadership energy are more likely to overcome challenges and obstacles in their roles. This energy allows them to stay motivated, resilient, and adaptable in the face of adversity. As a result, they are able to inspire and empower their team members to also perform at their best, creating a positive and productive work environment. Ultimately, by continuously nurturing their leadership energy, individuals can elevate their leadership capabilities and make a lasting impact on their organisation.

The theory posits that the energy emanating from the intricate interplay of leaders' orientation, experience, development, personality, and motivation engenders and perpetuates their efficacy and aptitude. Leaders who possess high levels of leadership energy are able to navigate challenges with grace and determination, setting an example for others to

follow. Their positive attitude and ability to adapt to changing circumstances can help drive their team towards success, even in the face of adversity. By honing their leadership energy, individuals can not only improve their own performance but also positively influence the overall success of their organization. The theory of leadership energy highlights the importance of self-awareness and continuous growth in order to become a truly effective leader. The intricate tapestry of leaders' orientation, the profound depths of their experience and growth, the essence of their character, and the enthusiasm that propels them forward intricately intertwine with the ebb and flow of this energy. Ultimately, the theory of leadership energy underscores the transformative power of individuals who choose to lead with passion, purpose, and authenticity.

The interplay of energy levels intricately governs the perpetuity and coherence of leaders' aptitude and efficacy. Leaders can cultivate a sense of purpose and ignite the energy necessary to make a lasting impact on their teams and organisations by consistently investing in their self-awareness and personal growth. Figure 1 summarizes the theoretical perspective. As illustrated in Figure 1, there is an interplay between leadership effectiveness and competence. For leaders to navigate the vast expanse of leadership situations with unwavering efficacy and longevity, they must draw upon a wellspring of leadership energy. This energy, a formidable force, arises from the harmonious convergence of leadership orientation, experience, development, personality, and motivation. Figure 2 presents the hypothesized model that would enable the testing and validation of this theory. It unveils the essence of the theory, encapsulated within three main hypotheses, denoted as H1, H2, and H3. Furthermore, these main hypotheses give rise to nine sub-hypotheses, each bearing its own unique designation, namely H1a–H1e, H2a–H2b, and H3a–H3b.

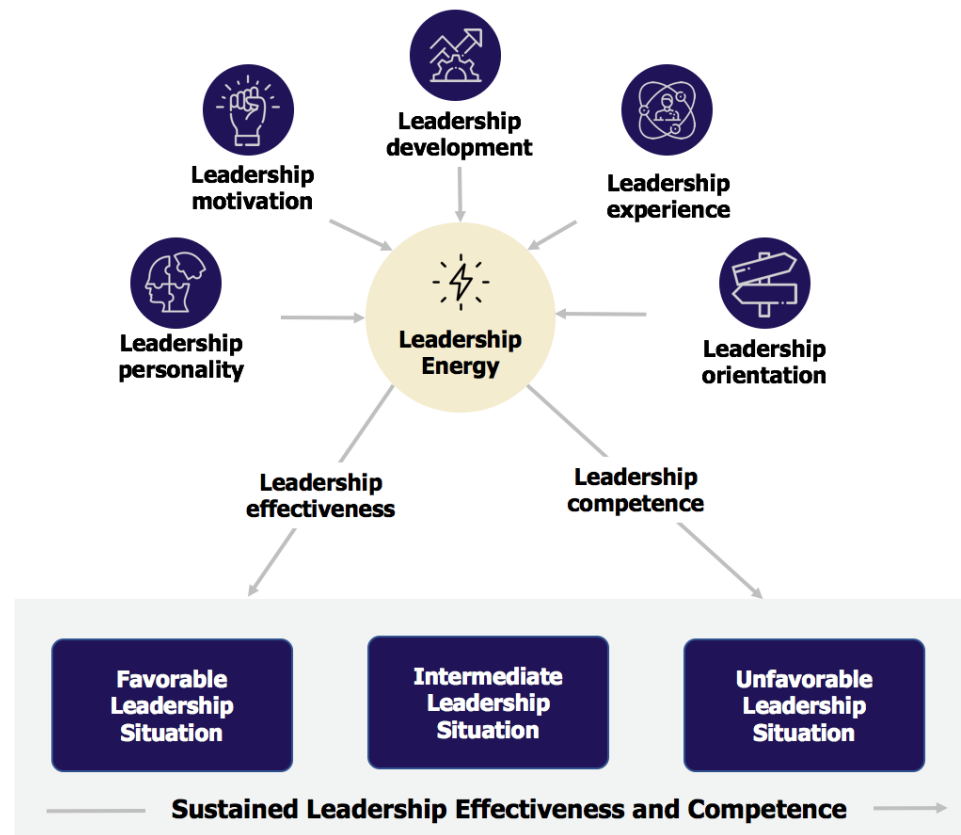
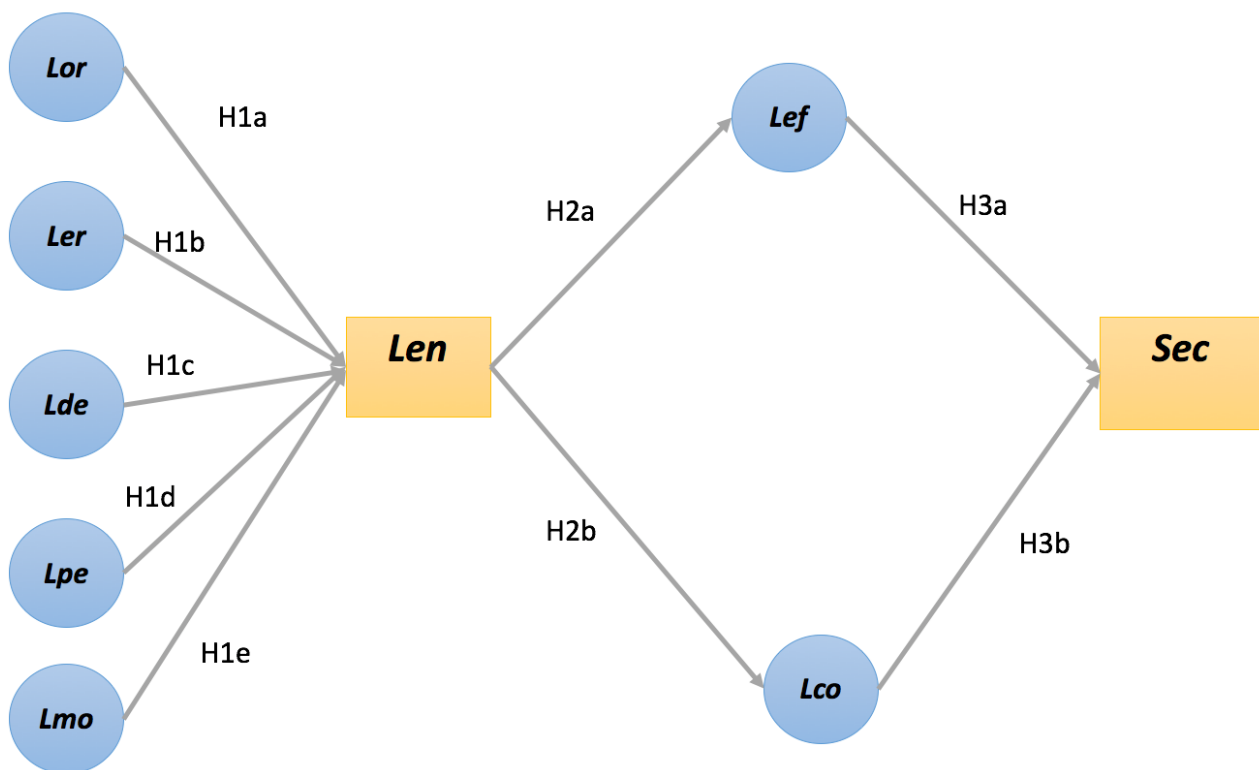

Figure 1. Conceptual model of leadership energy for sustainable leadership effectiveness and competence.



**Figure 2.** The hypothesized model of leadership energy for sustainable leadership effectiveness and competence (*Lor*—leadership orientation, *Ler*—leadership experience, *Lde*—leadership development, *Lpe*—leadership personality, *Lmo*—leadership motivation, *Len*—leadership energy, *Lef*—leadership effectiveness, *Lco*—leadership competence, *Sec*—sustained leadership effectiveness and competence).

### 3. Methodology

This study utilizes a hypothetico-deductive research philosophy and design. The hypothetico-deductive (HD) research philosophy entails a cyclic process of logical deduction and empirical observation employed to formulate and examine theoretical propositions [37,38]. The objective of this approach is to extract valuable knowledge by determining causality in a manner that enables the reliable prediction of future events. The HD approach, as its name suggests, consists of two essential components: a hypothetico component, wherein hypotheses derived from the proposed theory are subjected to rigorous testing, and a deductive component, wherein a validated theory is derived from the hypotheses that have been tested. Thus, the optimal configuration of a hypothetico-deductive research approach involves the establishment of a research problem, the formulation of hypotheses, the collection of data, the testing of hypotheses, the interpretation of cues, the deduction of theory, and the formulation of a conclusion.

The study involved the participation of 272 leaders from various industries. Incomplete questionnaires resulted in a reduction in the participant pool to 272 individuals, representing 66% of the original sample size of 412 participants who were initially contacted. The participants were contacted through personal outreach methods, such as direct contact or the distribution of unsolicited correspondence. Utilizing the respondent-driven sampling technique (similar to snowballing sampling strategy), participants were incentivized to extend invitations to their respective networks, ensuring the survey's confidentiality and voluntary nature. The participants were approached through personalised outreach strategies, such as direct communication or the dissemination of unsolicited letters. This technique was used to guarantee the inclusion of a heterogeneous group of people with varying backgrounds and experiences. Despite initial challenges in reaching potential volunteers, the response was overwhelmingly positive. The individualised outreach efforts

resulted in a substantial degree of involvement and enthusiasm in the research, ultimately culminating in a diverse cohort of volunteers.

Employing the respondent-driven sampling technique, similar to the snowball sampling strategy, motivated participants to invite others from their networks to participate in the survey. This approach maintained the survey's confidentiality and voluntary nature, enabling the study to incorporate a broader spectrum of viewpoints. The sampling procedure demonstrated efficacy in obtaining people who may have been inaccessible through conventional recruitment strategies. By harnessing the influence of social networks and spreading information through personal recommendations, the study successfully attracted a diverse group of individuals who were enthusiastic about sharing their distinct perspectives and personal experiences. The study's success may be due to the effective mix of personal outreach efforts and the use of unique sampling methodologies, which resulted in the formation of a comprehensive and representative group of participants.

The participants reported engaging in various forms of leadership training, including workshops and seminars (24%), self-directed learning (26%), feedback (2%), coaching and mentoring (4%), and on-the-job learning (44%). The participants provided data indicating that a portion of them, specifically 20%, reported having spent a duration of 6 months in leadership positions. Additionally, 28% of the participants reported having occupied leadership positions for a period ranging from 1 to 2 years. Furthermore, 21% of the participants reported spending 3 to 4 years in leadership positions. Lastly, the highest percentage, specifically 36%, of the participants reported having spent 5 years or more in leadership positions. The participants' reports indicate that the number of subordinates reported falls within three categories: 5–15 subordinates (41%), 16–26 subordinates (36%), and 27 or more subordinates (21%). The individuals surveyed have self-identified as belonging to various sectors, namely the education sector (11%), construction sector (22%), banking and financial services sector (16%), consulting sector (15%), hospitality sector (13%), and other industries (24%). The individuals under observation possess various educational qualifications, with 36% holding graduate degrees and 64% holding post-graduate degrees. This observation substantiates the veracity of the data provided by the participants.

The questionnaire survey was utilised to directly quantify seven variables, as illustrated in Figure 2. These variables were derived from the theoretical framework discussed in Section 2. Table 1 presents the variables along with the respective significance of their items. The items within the questionnaire survey were evaluated using a five-point scale, wherein a rating of 1 corresponds to strong disagreement and a rating of 5 corresponds to strong agreement. The participants' level of agreement with the items was assessed using a scale that ranged from 1.00 to 5.00. The scale was divided into five categories: highly disagree (1.00–1.80), disagree (1.81–2.60), neutral (2.61–3.40), agree (3.41–4.20), and highly agree (4.21–5.00). Prior to conducting data analysis, the Cronbach's coefficient was computed in order to evaluate the reliability of the variables. The obtained results indicate a leadership orientation score of 0.77, a leadership experience score of 0.77, a leadership development score of 0.81, a leadership personality score of 0.79, a leadership motivation score of 0.71, a leadership effectiveness score of 0.75, and a leadership competence score of 0.73.

Cronbach's coefficient values exceeding 0.7 are deemed to be within the acceptable range. The mean item score was employed to determine the variables that exhibited statistical significance. The study assessed the discriminant validity, confirmatory factor analysis, and internal consistency of the items in order to identify and subsequently eliminate any insignificant ones. All of the observed variables were determined to be statistically significant, as their respective values exceeded the threshold of 5.0. These variables include leadership orientation (0.64), leadership experience (0.99), leadership development (0.92), leadership personality (0.83), leadership motivation (0.84), leadership effectiveness (0.71), and leadership competence (0.73). The items of significance underwent additional analysis in order to test the hypotheses presented in Figure 2 through the use of structural equation modelling (SEM).



**Table 1.** Parameter estimates for the path model.

Hypothesis	Estimate (r)	Standard Error	Z-Score	Interpretation
H1a (Lor->Len)	0.806	1017.132	$7.922 \times 10^{-4}$	Supported
H1b (Ler->Len)	0.638	1872.533	$3.407 \times 10^{-4}$	Supported
H1c (Lde->Len)	0.606	0.129	4.679	Supported
H1d (Lpe->Len)	0.958	1872.533	$5.118 \times 10^{-4}$	Supported
H1e (Lmo->Len)	0.986	1017.132	$9.693 \times 10^{-4}$	Supported
H2a (Len->Lef)	0.333	977.212	$3.407 \times 10^{-4}$	Supported
H2b (Len->Lco)	1.348	0.344	3.917	Supported
H3a (Lef->Sec)	0.176	85.347	0.002	Supported
H3b (Lco->Sec)	0.428	0.166	2.5801	Supported

$\chi^2$ : 3013.2810; restricted degrees of freedom: 18; degrees of freedom (indep.): 36;  $\chi^2$  from independent: 199.353; RMSEA (Kulback Leibler): 0.012; RMSEA (classic): 0.298; SRMR (covariances only): 0.194; CFI (to independent model): 0.839; TLI (to independent model): 0.679.

Structural equation modelling (SEM) is a statistical technique used to analyse intricate connections between constructs and indicators in multivariate data analysis. SEM enables researchers to evaluate theoretical models by concurrently analysing both observable and latent variables. SEM, or structural equation modelling, enhances the accuracy of estimating correlations between variables by taking measurement error into account. In addition, SEM may evaluate the overall adequacy of the model to the data, enabling researchers to ascertain the validity of their theoretical framework. SEM, or structural equation modelling, is an effective approach that researchers may use to get insights into intricate linkages within their data [39]. The goodness-of-fit indices used in structural equation modelling encompass tests such as the comparative fit index (CFI), root mean square error of approximation (RMSEA), and chi-square test. These indices were interpreted using the appropriate cut-off points [40–43]. The chi-square test compares the population covariances suggested by the model to the covariances seen in the sample. Additionally, there are numerous fit indices that might yield contradictory findings on the appropriateness of the model. The fit requirements of a structural equation model generally assess the degree to which the given model accurately represents the observed data. Only the chi-square test statistic has an accompanying significance test, while all other measures are simply described.

#### 4. Results

A mean item score analysis was performed to determine the statistical significance and relevance of the observed variables in relation to leadership energy. A cut-off point of 3.41 was used to identify variables that exhibited a high level of significance. As depicted in Figure 3, the variables under examination encompass leadership orientation, experience, development, personality, and motivation. The measurement of leadership orientation was conducted using four distinct items. It was unanimously agreed upon by all respondents that in order to possess leadership energy, leaders must possess the capability to interpret situations (mean score = 4.3), respond to situations (mean score = 4.4), make decisions (mean score = 4.3), and derive meaning from situations (mean score = 3.8). The quantification of leadership experience was conducted through the use of six distinct items. All of the items achieved a minimum score of 3.41. The data suggest that all the participants reached a consensus that in order to possess leadership energy, a leader must possess the capability to effectively utilize positional power, value the importance of teamwork and cooperation, acknowledge the significance of their followers' development and directiveness, and demonstrate an appreciation for assertiveness.

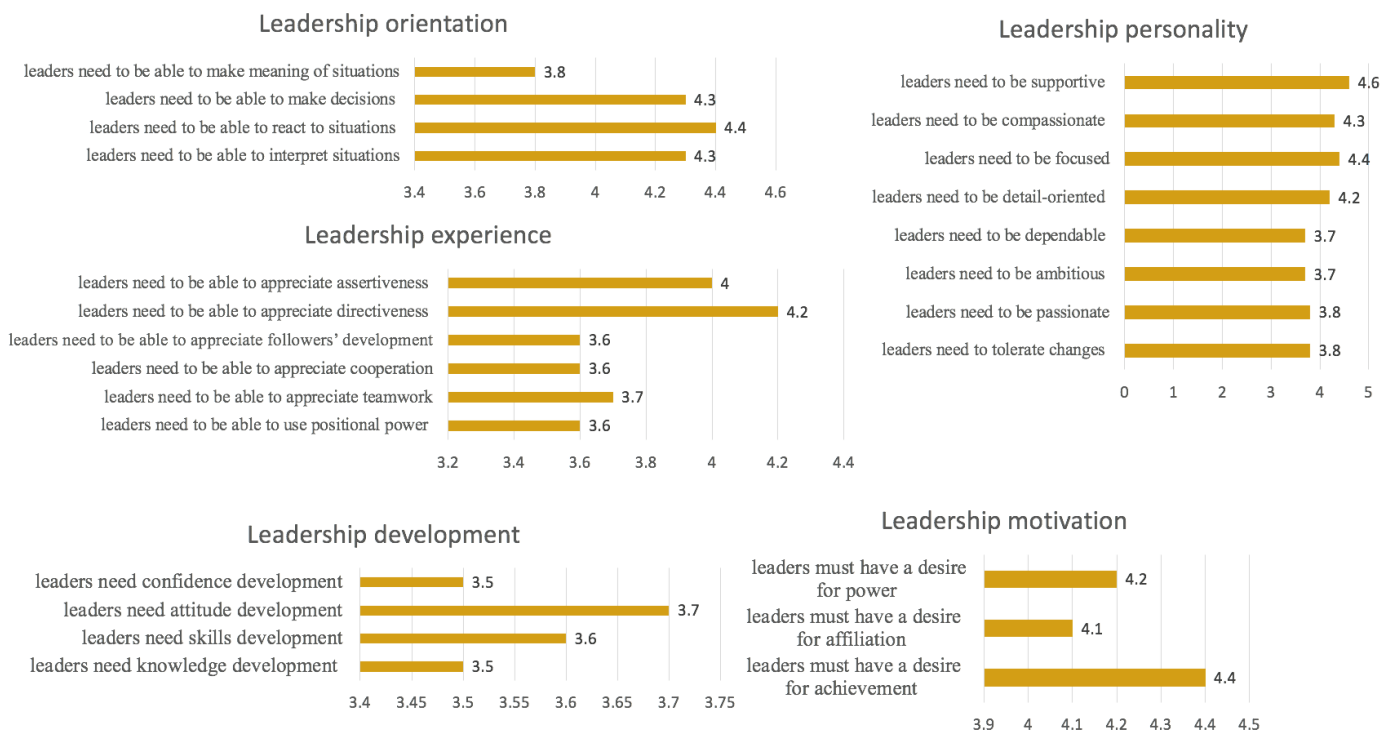
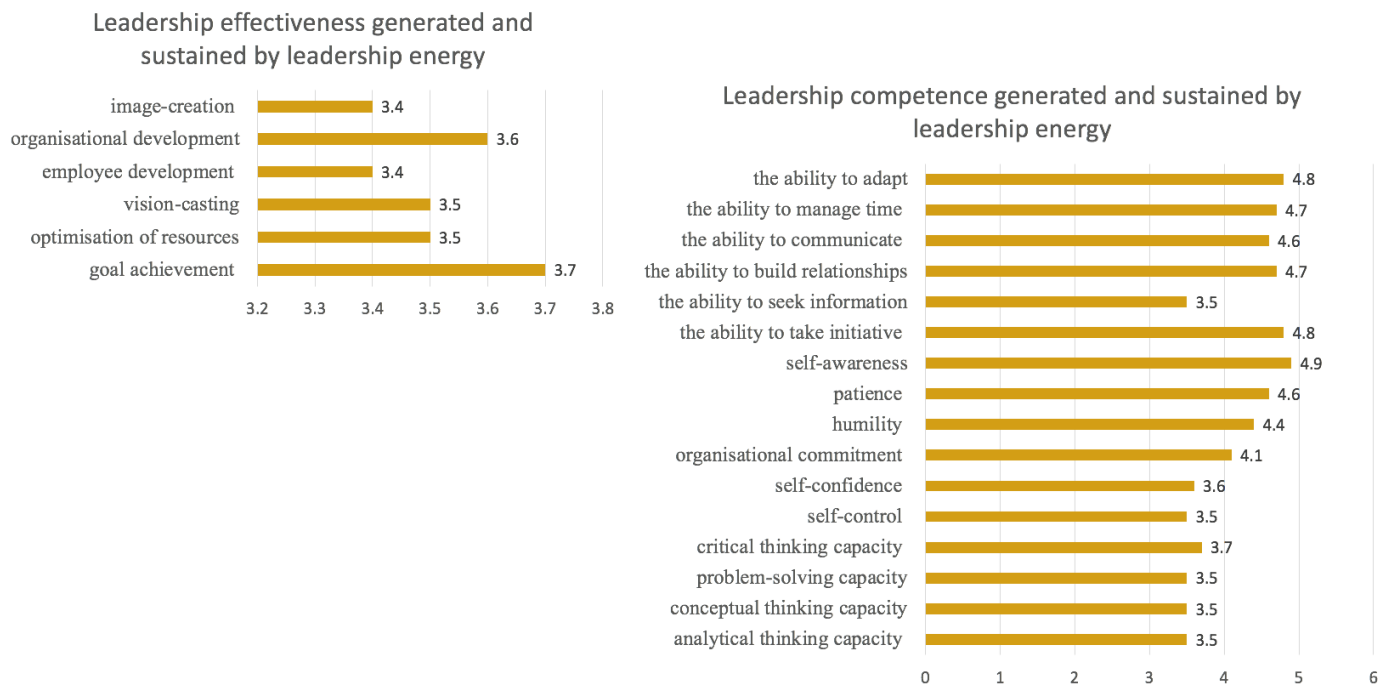

Figure 3. Sources of leadership energy.

The quantification of leadership development was conducted through the assessment of knowledge development (mean score = 3.5), skill development (mean score = 3.6), attitude development (mean score = 3.7), and confidence development (mean score = 3.5). The mean item scores of the participants indicated unanimous agreement regarding the adequacy of the measurements in assessing leadership development. All eight of the items employed for the assessment of leadership personality exhibited scores surpassing the established threshold of 3.41. This observation suggests that all the propositions were unanimously endorsed by the participants and hold considerable statistical significance. The constructs of need for achievement (MS = 4.4), need for affiliation (MS = 4.1), and need for power (MS = 4.2) were employed as the indicators for assessing leadership motivation. The average scores of the items demonstrate a notable level of significance and a substantial degree of consensus among the participants. The observed significance of these variables as potential sources of leadership energy, as indicated by the responses provided by the research participants, implies that leadership energy could potentially be derived from the amalgamation of these variables. The findings additionally indicate that a leader’s capacity to respond to circumstances, comprehend the necessity for assertiveness, prioritize attitude cultivation and supportiveness, and grasp the importance of achievement would contribute to the internal mechanism necessary for the leader’s manifestation of leadership energy.

4.1. Leadership Effectiveness and Competence Generated and Sustained by Leadership Energy

The relevance and significance of leadership effectiveness and competence, as generated and sustained by leadership energy, were established through the utilization of the mean item score. The data presented in Figure 4 indicate that the participants expressed a consensus regarding the measurement of leadership effectiveness and competence. This is evident from the mean item scores, which consistently exceed 3.41. The measurement of leadership effectiveness was conducted by assessing goal achievement (MS = 3.7), resource optimization (MS = 3.5), vision casting (MS = 3.5), employee development (MS = 3.4), organizational development (MS = 3.6), and image creation (MS = 3.4). Utilizing a threshold of 3.41 as the cut-off point for attaining a high level of significance, it was determined that all the items under investigation exhibited a high level of statistical significance.



**Figure 4.** Leadership effectiveness and competence generated and sustained by leadership energy.

The findings indicate a potential correlation between leaders’ motivation to attain objectives, enhance the organization, cultivate followers, and optimize resources and their internal capacity and personal resilience, which emanates through their leadership energy. According to Figure 4, it is evident that the quantification of leadership competence can be effectively accomplished through the utilization of a set of sixteen distinct items. This confirmation was derived from the observation that the average scores of their items fall within the threshold for items of great significance. The findings suggest that the aptitude, attributes, and capabilities of leaders are derived and maintained through their internal capacity and personal fortitude, which emanate from their leadership energy.

*4.2. Testing the Leadership Energy Theory for Sustaining Leadership Effectiveness and Competence*

Figure 5 illustrates the structural equation model pertaining to the leadership energy theory. The depicted model illustrates a correlation among various factors related to leadership energy, including leadership orientation (Lor), leadership experience (Ler), leadership development (Lde), leadership personality (Lpe), and leadership motivation (Lmo). These factors collectively contribute to overall leadership energy (Len), which in turn influences leadership competence (Lco) and leadership effectiveness (Lef). Ultimately, sustained leadership effectiveness and competence (Sec) are outcomes influenced by the aforementioned factors and their interplay within the model. The analysis conducted utilizing structural equation modelling (SEM) aimed to ascertain a definitive and statistically significant correlation between the variables as follows: Lor->Len (H1a), Ler->Len (H1b), Lde->Len (H1c), Lpe->Len (H1d), Lmo->Len (H1e), Len->Lef (H2a), Len->Lco (H2b), Lef->Sec (H3a), and Lco->Sec (H3b). As evidenced by the data presented in Table 1 and Figure 6, the parameter estimates exhibit a satisfactory level of explanatory power, while the structural equation model demonstrates a reasonable degree of predictive capability, thereby indicating an acceptable level of validity. The estimated parameters indicate a robust and statistically significant association between Lmo and Len ( $r = 0.9859645625953727$ ;  $z = 9.693572089858704 \times 10^{-4}$ ), as well as between Lef and Sec ( $r = 0.17563485530825906$ ;  $z = 0.002057880435197908$ ).

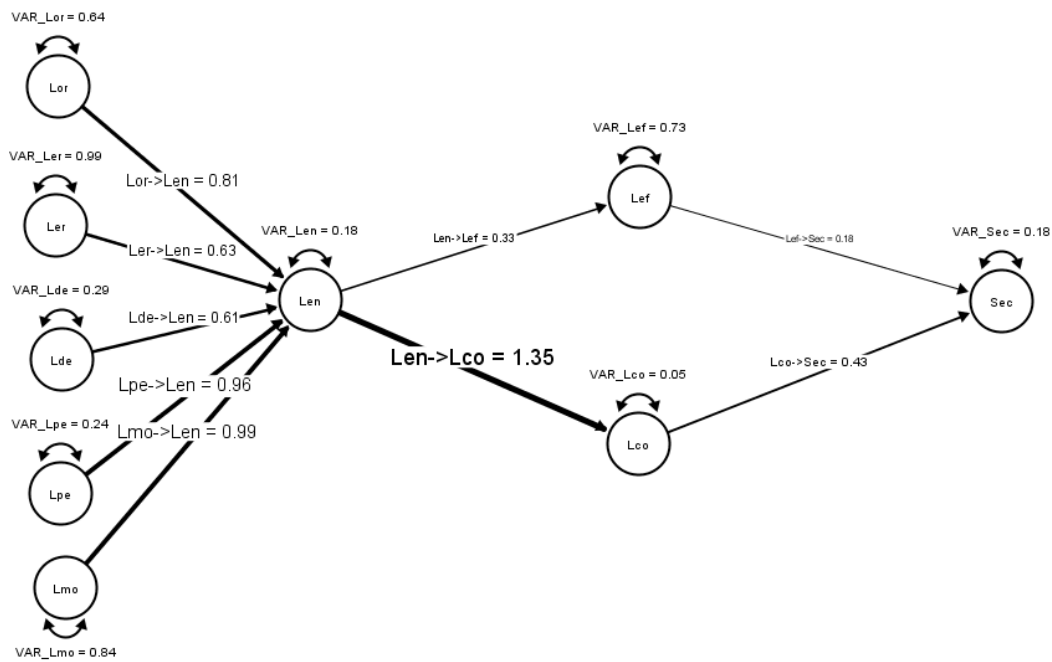

Figure 5. Structural equation model for the theory.

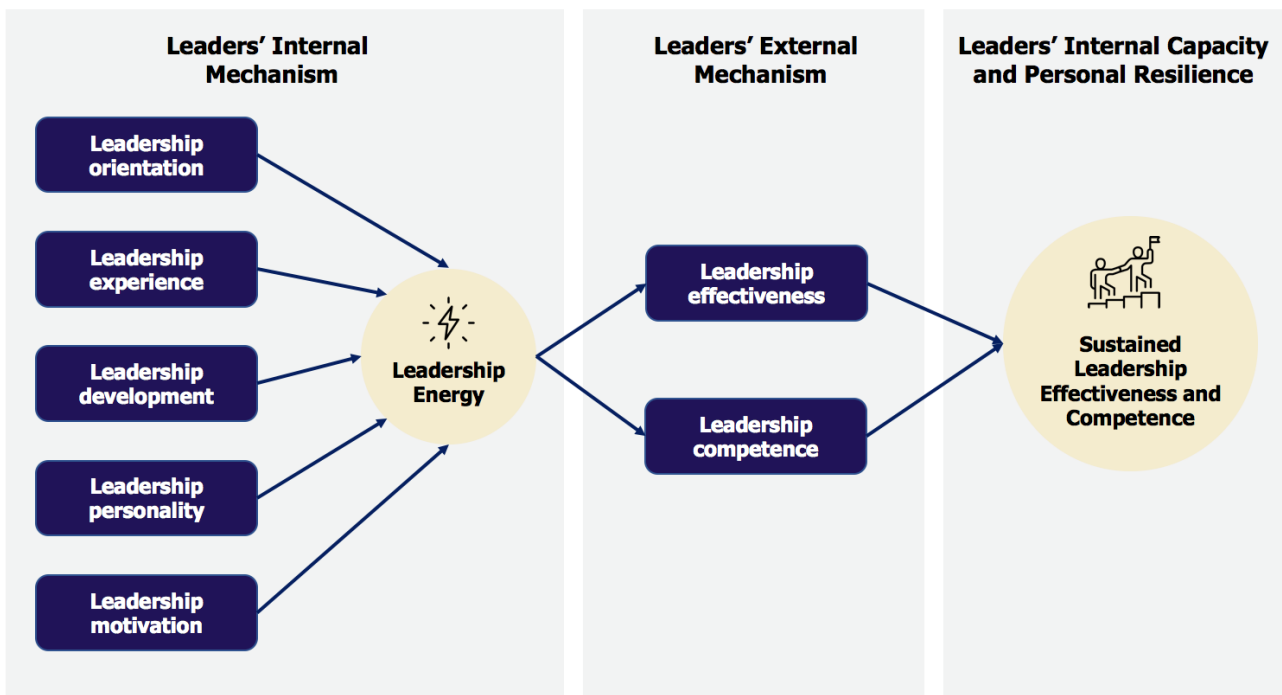

Figure 6. Illustration of the leadership energy theory.

The experimental findings indicate that all of the proposed hypotheses have been validated through the conducted test, as all of the pathways within the structural equation model align with the anticipated positive direction, as hypothesized. The findings indicate a strong correlation between leadership motivation ( $r = 0.9859645625953727$ ), leadership personality ( $r = 0.9584608316260745$ ), and leadership orientation ( $r = 0.8058124638136319$ ) and leadership energy. This observation suggests a clear causal relationship, suggesting that the motivation, personality, and orientation of a leader have a greater impact on the generation of leadership energy. Furthermore, this suggests that the level of leadership energy can be substantially regulated by these variables. In the examination of

the relationship between leadership effectiveness, leadership competence, and sustained leadership effectiveness and competence, the findings indicate that leadership competence ( $r = 0.4283838178366463975$ ) exhibits a greater influence on the perpetuation of leadership effectiveness and competence due to its stronger correlation. This phenomenon may be attributed to the superior attributes exhibited by leadership effectiveness in contrast to leadership competence. The fit indices presented in Table 1 indicate that the structural equation model demonstrates acceptability and provides supportive evidence for the theory of leadership energy.

## 5. Discussion

The results of this study indicate that the manifestation of leadership energy is contingent upon various factors, including leadership orientation, experience, development, personality traits, and motivation [22,24–26,30,32]. The results additionally unveiled that the motivation, personality, and orientation of leaders exert a more significant influence on the generation of leadership energy. The considerable importance of leadership orientation in the generation of leadership energy may stem from the fact that orientation is a cognitive process encompassing temporal, spatial, and personal awareness. The existence of purpose and vision within a leader's framework facilitates their ability to establish connections with phenomena from an introspective standpoint. In order to foster a positive culture and establish a competitive environment, it is imperative for leaders to undergo orientation. This orientation enables leaders to effectively cultivate an atmosphere in which employees perceive themselves as esteemed, respected, heard, and provided with avenues to make meaningful contributions [25]. The elevated significance of leadership personality in the generation of leadership energy may be attributed to the fact that personality exerts a compelling influence on the automatic or innate inclinations exhibited within a given situation. It facilitates the enhanced communication capabilities of a leader, enables them to evaluate the requirements of others, and facilitates the establishment of fruitful interpersonal connections.

Personality is a significant factor that influences workplace behaviour as it is observed that the cognitive processes, emotional experiences, and behavioural tendencies exhibited by leaders have a profound impact on various facets of the work environment. The personalities of leaders exert a significant influence on their behavioural patterns within groups, their attitudes, and their decision-making processes. In order to optimize workplace outcomes, mitigate stress and conflicts, and foster a positive outlook among workers, it is imperative for a proficient leader to conduct a comprehensive assessment of the aptitudes and limitations exhibited by each member of the team [30]. The absence of personality traits may lead leaders to exhibit a propensity for perceiving challenges in every circumstance, engaging in the act of critiquing individuals in their vicinity, experiencing difficulties in accurately assessing situations, and encountering obstacles in identifying suitable resolutions. In the absence of a clearly defined leadership persona, individuals in positions of leadership may encounter challenges in their long-term viability and in specific circumstances. The empirical evidence indicates that the motivation to lead is a fundamental determinant of the energy exerted by individuals in leadership positions. This phenomenon may be attributed to the multitude of advantages it offers, which effectively support the attainment of effective leadership. Leaders bear a significant obligation to cultivate motivation, a crucial element that frequently underpins their own personal fortitude and intrinsic impetus.

Motivation is an essential component that plays a pivotal role in the attainment of sustained success over an extended period of time. Leaders who are motivated are more inclined to exhibit the capacity to formulate a vision and effectively stimulate those under their guidance to attain it. Motivation is a cognitive attribute that facilitates individuals in establishing and attaining goal-directed objectives. It exerts a motivational force upon an individual, compelling them to exert diligent effort in the pursuit of their objectives. The significance of leadership motivation in the cultivation of leadership energy cannot

be overstated, as it facilitates the alteration of behavioural patterns, the enhancement of skill sets, the fostering of creativity, the establishment of objectives, the cultivation of personal interests, the formulation of strategic plans, the honing of talents, and the amplification of engagement levels. A fundamental element of effective leadership entails the ability to inspire individuals to attain shared objectives [35]. Leaders who possess intrinsic motivation tend to exhibit an enhanced proficiency in this endeavour. Motivated leaders frequently exhibit a fervent dedication to their professional endeavours, thereby establishing a paradigm that fosters comparable motivation among their subordinates, thereby propelling them towards enhanced performance. A leader who exhibits a high degree of motivational radiation has the potential to foster positive morale and stimulate optimal performance among employees. When individuals experience a state of motivation within their professional endeavours, they tend to exhibit elevated levels of psychological well-being, as well as positivity and optimism. This phenomenon can potentially engender enhanced internal aptitude and individual fortitude, as individuals may exhibit a heightened propensity for achieving desired outcomes, manifest an increased openness to novel concepts, demonstrate a greater inclination towards embracing uncertainty, and display a heightened capacity for adapting to dynamic circumstances. The presence of leadership motivation has been observed to facilitate the proficient transmission of a leader's vision, thereby fostering the acquisition of backing from individuals within their team. This phenomenon facilitates the enhancement of adaptability and resilience among leaders and their respective adherents, thereby conferring potential advantages during periods characterized by alterations and challenging circumstances.

The establishment of leadership development and experience has been identified as a significant contributing factor in the generation of leadership energy. Leadership development is a perpetual procedure involving the systematic instruction, enhancement, and refinement of leaders' aptitudes, thereby enabling them to function more effectively as a cohesive unit, propel organizational efficacy, and guarantee enduring viability. This statement suggests that the implementation of leadership development initiatives enables leaders to exert influence over the culture and strategy of their respective organizations, thereby facilitating the long-term maintenance of organizational performance. This implies that the process of leadership development equips individuals in positions of leadership with the necessary skills and knowledge to effectively navigate and address the forthcoming responsibilities and obstacles associated with leadership, both in the present and in the future. In this context, the resilience of individuals is significantly amplified, thereby endowing them with an inherent capacity and personal fortitude to assume leadership roles within a tumultuous and transformative global landscape. Another significant aspect of leadership development in the generation of leadership energy may stem from its continuous nature, which perpetually enhances the leaders' aptitude and erudition, thereby enabling them to sustain their competence and efficacy within their leadership capacity.

The empirical evidence elucidated that the acquisition of leadership experience positively correlates with the augmentation of leadership energy. The probable explanation for this phenomenon may stem from the fact that through successive instances of assuming leadership roles, individuals not only acquire valuable competencies, but also cultivate a sense of self-assurance in their ability to collaborate with others in overcoming diverse challenges. This observation suggests that the development of resilience in leaders is not an inherent trait, but rather a gradual process influenced by a multitude of personal and professional encounters over an extended period of time. Leadership experiences facilitate the acquisition of knowledge and the discovery of novel perspectives by individuals in positions of leadership. It facilitates the individuals in effectively navigating their present challenges and actively moulds their future trajectory by instilling a heightened sense of awareness and intentionality in seeking out opportunities for leadership advancement and personal growth [22]. In this manner, individuals direct their attention towards the cultivation of fundamental leadership aptitude, a necessary attribute in all professional pursuits, circumstances, and capacities. The findings of this study additionally propose

that leaders who exhibit resilience may acquire such resilience through experiential means. Leadership experience acquired through assuming leadership positions facilitates the honing of leadership aptitudes, identification of personal strengths, and exploration of optimal leadership approaches across diverse circumstances.

### *5.1. Leadership Effectiveness and Competence Generated and Sustained by Leadership Energy*

The results indicate that the various components of leadership effectiveness and competence can be significantly produced and maintained through the utilization of leadership energy. The results, however, indicate that leadership energy has the potential to generate and sustain critical thinking, organizational commitment, the ability to take initiative, and the ability to adapt, which are key factors for efficacy and proficiency [17,19,20,34]. The cultivation of critical thinking skills is an indispensable attribute for effective leadership, without a doubt. The application of critical thinking enables leaders to transcend the limitations imposed by assumptions and biases, thereby enhancing the efficacy of decision-making processes. Through the cultivation of their cognitive abilities, leaders engage in proactive measures to enhance their cognitive processes and optimize the strategic choices they make, thereby bolstering the overall standing of their organization. The application of critical thinking enhances the probability of favourable outcomes as it is characterized by logical reasoning, deliberate intentionality, and a focus on achieving specific objectives. It facilitates the ability of leaders to generate well-informed and pertinent deductions, resolve issues, compute probabilities, and engage in problem-solving endeavours with lucidity, rationality, and a methodical methodology [20]. The application of critical thinking skills empowers individuals in leadership positions across all levels to comprehend the ramifications of their choices for the entirety of the business. This practise guarantees that their decisions are in accordance with the objectives of the organization and that they are held responsible for the outcomes they produce.

Organizational commitment facilitates the perseverance of leaders in adhering to their objectives amidst favourable and unfavourable circumstances. Effective leaders demonstrate a steadfast dedication to the achievement of their organization's objectives and the well-being of its personnel [17]. The individuals exhibit unwavering dedication towards the organization's overarching objectives, demonstrating resilience in the face of transient obstacles without succumbing to discouragement. When confronted with an obstacle, proficient leaders possess the ability to perceive beyond the hindrances impeding their progress towards a shared objective. As evidenced by empirical observations, the capacity to exhibit proactive behaviour is an indispensable trait in the realm of leadership, as it enables efficacious leaders to abstain from passively awaiting instructions or guidance regarding their course of action. The individuals under consideration exhibit cognitive agility and promptly execute suitable measures. The capacity to exhibit initiative enables leaders to adopt a proactive stance rather than a reactive one. It additionally manifests as flexibility, confidence, and courage. This phenomenon can be attributed to the manifestation of initiative, which serves as an indicator of confidence, an elevated self-esteem, and a propensity to work hard. Engaging in proactive behaviour entails the establishment of objectives, their successful attainment, and the autonomous execution of assigned duties.

The results additionally revealed that the capacity to adapt is a fundamental characteristic of efficacious leaders and is intricately connected to leadership energy. This phenomenon may arise due to the observation that, in the context of leadership, adaptability pertains to the possession of readily available cognitive frameworks, thereby empowering leaders to dynamically shift and engage in experimental approaches in response to changing circumstances [20,34]. The possession of an elastic cognitive approach enables leaders to employ diverse cognitive strategies, leadership modalities, and mental frameworks. Leaders who possess adaptability exhibit a cognitive orientation wherein they perceive inherent value in the presence of challenges as opposed to evading or avoiding said challenges. Instead, individuals confront challenges directly, as they know that substantial knowledge can be acquired through the examination of errors and impediments.

### *5.2. Leadership Energy Theory for Sustaining Leadership Effectiveness and Competence*

This study's findings have successfully validated all three of the hypotheses that encompass the leadership energy theory (see Figure 6 for an illustration of the theory).

The empirical verification of the hypotheses suggests that leaders obtain their effectiveness and competence through the utilization of leadership energy. The hypotheses that have been validated also suggest that the ongoing and consistent competence and effectiveness of leaders are directly dependent on their level of effectiveness and competence, which can be derived from their level of leadership energy. The aforementioned statement posits that the energy level exhibited by an individual in a leadership role directly influences their level of effectiveness and competence in said role. Hence, it is imperative to uphold a consistent level of energy in leadership, as an uninterrupted stream of leadership efficacy is crucial for fostering a clarity in one's objectives and inspiring and directing the organization towards the attainment of its mission.

In the absence of a guiding figure to elucidate the overarching vision and delineate the requisite actions for its attainment, the realization of said vision is likely to be arduous. In the absence of a proficient leader who can effectively channel individual endeavours towards a shared objective, the mere presence of talents and capabilities within an organization does not ensure triumph, rendering all other resources ineffective. An optimal manifestation of leadership ensures the provision of mentorship, accountability, and the judicious allocation of responsibilities. The findings of the study additionally underscore the significance of leadership energy in relation to leadership competence. Leadership competence can be defined as a comprehensive amalgamation of knowledge, skills, abilities, and behaviours that, when synergistically integrated, culminate in the manifestation of an efficacious leader. This implies that competence in leadership plays a role in enhancing the effectiveness of leadership by endowing leaders with the necessary vigour to motivate individuals in their vicinity and augment the worth of their organization. The ascertainable, quantifiable, consistent, and lucid manifestation of a leader's efficacy is facilitated by their aptitude for leadership. Leadership competence can be succinctly characterized as the delineation of the requisite leadership attributes and the comprehensive portrayal of the efficacious leader's profile.

Due to the observed correlation between leadership competence and effectiveness, it is imperative to maintain these qualities in order to ensure optimal outcomes. As indicated by the findings of this study, it is evident that the leadership of an organization must not only achieve success in the present but also sustain perpetual success in order to maintain control and thrive. However, the maintenance of leadership efficacy in organizational performance across temporal intervals and under various circumstances presents a formidable challenge. Nevertheless, by maintaining a consistent influx of leadership energy, the enduring viability of leadership efficacy is ensured. Sustained leadership competence and effectiveness, driven by leadership energy, are imperative as leaders consistently face pressure stemming from workplace disruptions and the swift pace of business transformations. Furthermore, the intricate and multifaceted nature of contemporary business necessitates the unwavering presence of leadership competence and effectiveness. The observed inclination towards an increased utilization of remote and geographically separated work arrangements, coupled with the subsequent outcome of overseeing a team from a distance, spanning multiple locations and time zones, poses a distinct challenge for leaders in maintaining a consistent state of operational efficiency and proficiency. The rapid progression of technology and the increasing diversity within organizations have presented a significant leadership quandary. Leaders are now required to adapt to constant change while maintaining their competence and effectiveness across various scenarios. In the current state, it has become increasingly unfeasible for leaders to regard competence and effectiveness as sporadic occurrences. In order to fully realize their leadership potential, it is imperative that individuals enhance their efficiency. This entails perceiving improvement as the prevailing standard, embracing disruption as a chance for growth, regarding learning as an inherent entitlement, nurturing



skills and personal development, and recognizing competence as an ongoing and perpetual endeavour.

## 6. Conclusions

The manifestation of leadership energy, which encompasses inherent aptitude and individual fortitude, is derived from factors such as orientation, experience, development, personality, and motivation, as demonstrated by leaders. The generation and maintenance of leadership energy is instrumental in facilitating the efficacy and proficiency of leaders, primarily through the utilization of cognitive processes such as analytical reasoning, an unwavering dedication to the organization, a proclivity for proactive action, and adeptness in adapting to dynamic circumstances. The study's findings indicate that in order to maintain sustainable leadership competence and effectiveness, it is imperative for leaders to foster a culture that prioritises effectiveness and competence. This entails integrating leadership competence with a culture that embraces effective leadership practises, thereby optimizing effectiveness, enhancing organizational resilience, fostering a drive to surpass existing capabilities and expectations, and ensuring organizational adaptability and preparedness for future challenges. The inevitability of change and challenges necessitates that leaders possess the ability to effectively adapt to altering circumstances. This adaptability is crucial in order to cultivate resilience and successfully navigate unforeseen and arduous situations that may arise as a result of these transformations.

Leadership should prioritize the assessment of effectiveness and competence, with a greater emphasis on maintaining these qualities. This is imperative due to the perpetual obligation of leaders to fulfil their responsibilities, enhance their leadership aptitude, and confront novel challenges. By consistently evaluating their effectiveness and competence, leaders can ensure they are meeting the needs of their team and organisation. This ongoing assessment allows leaders to make necessary adjustments to their approach and decision making, ultimately leading to improved outcomes and success. Additionally, prioritising these qualities helps leaders build trust and credibility with their team, fostering a positive and productive work environment. For example, a leader who regularly seeks feedback from employees and stakeholders can identify areas for improvement in their leadership style and make necessary changes to better support their team. By demonstrating a willingness to adapt and grow, the leader can inspire confidence in their ability to lead effectively, ultimately driving the success of the organisation as a whole.

Through the consistent demonstration of effective leadership and the display of competence, leaders would perceive challenges as valuable opportunities rather than avoiding conflict. When leaders have the knowledge and skills to maintain efficacy and proficiency, they will gain comprehension of heterogeneous cognitive processes and exhibit a willingness to venture beyond their accustomed boundaries. As a result, leaders will be better equipped to navigate complex and unpredictable situations, making informed decisions that benefit the organisation and its stakeholders. By embracing a growth mindset and continually seeking to improve themselves, leaders can foster a culture of innovation and continuous learning within their organisation. In doing so, they will not only inspire their team members to reach their full potential, but they will also drive the organisation's long-term success and sustainability. For example, a leader who embraces a growth mindset may encourage team members to participate in cross-functional projects, allowing them to gain new skills and perspectives. This can lead to increased collaboration, creativity, and problem-solving abilities within the organisation, ultimately driving innovation and growth.

Through the maintenance of sustained leadership effectiveness and competence, derived from the acquisition and utilisation of leadership energy, leaders cultivate a state of resiliency that enables them to flourish amidst the presence of change and uncertainty. By fostering a culture of continuous learning and development, a growth-minded leader can empower their team to adapt and thrive in an ever-evolving business environment. Adaptability and resilience not only benefit the team but also contribute to the overall success and

sustainability of the organisation. As a result, the organisation is better equipped to navigate challenges and seize opportunities for growth and advancement. Ultimately, a growth mindset not only enhances individual and team performance but also fosters a culture of innovation and progress that propels the organisation forward. Furthermore, this resiliency will empower leaders to proactively address challenging circumstances and effectively navigate conflicts in a constructive manner. In doing so, leaders will inspire confidence and trust among their team members, fostering a culture of innovation and growth within the organisation. This positive and forward-thinking environment encourages employees to take risks, think creatively, and continuously improve upon existing processes. As a result, the organisation will be able to adapt more easily to changing market conditions and emerging trends, staying ahead of the competition. By embracing a growth mindset and fostering a culture of innovation, the organisation sets itself up for long-term success and sustainable growth.

## 7. Limitations and Future Studies

The present investigation exhibits a number of constraints that could potentially be rectified in subsequent research endeavours. The data analysis was exclusively predicated on the responses provided by the research participants and was not amalgamated with other data sources derived from objective measurement. It would also be advantageous to replicate the study's findings using larger sample sizes and conducting studies in diverse cultural or geographical contexts. The investigation of the potential impact of leadership intelligence on the generation and maintenance of leadership energy warrants further exploration. Furthermore, it is imperative to investigate the impact of diversity and the calibre of leadership experience on the efficacy and proficiency of leadership. Individuals exhibit unique variations in their repertoire of experiences, which in turn impart distinct knowledge and insights. Moreover, specific developmental experiences hold varying degrees of significance relative to others. Given the inherent variability in individuals' personalities and other traits, ascertaining the likelihood of an individual's acquisition of knowledge from a particular experience, as well as the uniformity of learning outcomes among individuals with distinct personalities exposed to the same experience, proves to be a challenging endeavour. An investigation into how developmental experiences contribute to the enhancement of leadership energy is warranted.

**Author Contributions:** Conceptualization, O.O.; methodology, A.O.; software, O.O.; validation, A.O., O.E. and O.O.; formal analysis, O.O.; investigation, E.D.O.; resources, E.D.O. and O.E.; data curation, E.D.O.; writing—original draft preparation, O.O.; writing—review and editing, A.O. and O.E.; visualization, A.O. and O.O.; supervision, O.E. and A.O.; project administration, E.D.O.; funding acquisition, A.O. and O.E. All authors have read and agreed to the published version of the manuscript.

**Funding:** This research received no external funding.

**Institutional Review Board Statement:** The study protocol was approved by the Departmental Ethics Committee of Obafemi Awolowo University (BLD-RE-UNDRG-00012/14 January 2023).

**Informed Consent Statement:** Informed consent was obtained from all subjects involved in the study.

**Data Availability Statement:** The data presented in this study are available on request from the corresponding author due to ethical reasons.

**Conflicts of Interest:** The authors declare no conflict of interest.

## References

1. Gilley, A.; Gilley, J.W.; McMillan, H.S. Organizational change: Motivation, communication, and leadership effectiveness. *Perform. Improv. Q.* **2009**, *21*, 75–94. [[CrossRef](#)]
2. Sprenger, J. Hypothetico-deductive confirmation. *Philos. Compass* **2011**, *6*, 497–508. [[CrossRef](#)]

3. Chen, T.Y. Medical leadership: An important and required competency for medical students. *Tzu-Chi Med. J.* **2018**, *30*, 66. [CrossRef] [PubMed]
4. Edelman, P.; van Knippenberg, D. Emotional intelligence, management of subordinate's emotions, and leadership effectiveness. *Leadersh. Organ. Dev. J.* **2018**, *39*, 592–607. [CrossRef]
5. Kerr, I.R. Leadership Strategies for Sustainable Enterprise Operation. Ph.D. Thesis, RMIT University Library, Melbourne, Australia, 2002.
6. Yahaya, N.; Taib, M.A.B.M.; Ismail, J.; Shariff, Z.; Yahaya, A.; Boon, Y.; Hashim, S. Relationship between leadership personality types and source of power and leadership styles among managers. *Afr. J. Bus. Manag.* **2011**, *5*, 9635.
7. Tai, M.K.; Omar, A.K.; Mohamad, S.N.; Khuan, W.B. The development of a principal change leadership competency model: A structural equation modelling (SEM) approach. *J. Commonw. Counc. Educ. Adm. Manag.* **2014**, *42*, 3–45.
8. Shanafelt, T.D.; Makowski, M.S.; Wang, H.; Bohman, B.; Leonard, M.; Harrington, R.A.; Minor, L.; Trockel, M. Association of burnout, professional fulfillment, and self-care practices of physician leaders with their independently rated leadership effectiveness. *JAMA Netw. Open* **2020**, *3*, e207961. [CrossRef] [PubMed]
9. Limsila, K.; Ogunlana, S.O. Performance and leadership outcome correlates of leadership styles and subordinate commitment. *Eng. Constr. Archit. Manag.* **2008**, *15*, 164–184. [CrossRef]
10. Sonmez Cakir, F.; Adiguzel, Z. Analysis of leader effectiveness in organization and knowledge sharing behavior on employees and organization. *Sage Open* **2020**, *10*, 2158244020914634. [CrossRef]
11. Jankelová, N.; Joniaková, Z. Communication skills and transformational leadership style of first-line nurse managers in relation to job satisfaction of nurses and moderators of this relationship. *Healthcare* **2021**, *9*, 346. [CrossRef]
12. Andersen, J.A. Leadership, personality and effectiveness. *J. Socio-Econ.* **2006**, *35*, 1078–1091. [CrossRef]
13. Dhar, U.; Mishra, P. Leadership effectiveness. *J. Manag. Res.* **2001**, *1*, 254–266.
14. Hollenbeck, G.P.; McCall, M.W., Jr.; Silzer, R.F. Leadership competency models. *Leadersh. Q.* **2006**, *17*, 398–413. [CrossRef]
15. Erkutlu, H. The impact of transformational leadership on organisational and leadership effectiveness: The Turkish case. *J. Manag. Dev.* **2008**, *27*, 708–726. [CrossRef]
16. Van Knippenberg, D.; Hogg, M.A. A social identity model of leadership effectiveness in organisations. *Res. Organ. Behav.* **2003**, *25*, 243–295.
17. Watkins, S. Becoming autonomous and autonomy-supportive of others: Student community leaders' reflective learning experiences in a leadership training course. *JASAL J.* **2021**, *2*, 4–25.
18. Olugboyege, O.; Ejohwomu, O.; Omopariola, E.D.; Omoregie, A. Project Leadership Functions and the Associated Behaviour for Projects and Project Organisations. *Buildings* **2023**, *13*, 1739. [CrossRef]
19. Kragt, D.; Guenter, H. Why and when leadership training predicts effectiveness: The role of leader identity and leadership experience. *Leadersh. Organ. Dev. J.* **2018**, *39*, 406–418. [CrossRef]
20. Michael, D.W. Energy, Focus, and Five Other Key Skills for Future Leaders. 2022. Available online: <https://www.imd.org/ibyimd/leadership/energy-focus-and-five-other-key-skills-for-future-leaders/> (accessed on 4 July 2023).
21. Nichols, A.L. What do people desire in their leaders? The effect of leadership experience on desired leadership traits. *Leadersh. Organ. Dev. J.* **2016**, *37*, 658–671. [CrossRef]
22. Patching, K. Throw away that leadership competency model. *Ind. Commer. Train.* **2011**, *43*, 160–165. [CrossRef]
23. McCall, M.W., Jr. Leadership development through experience. *Acad. Manag. Perspect.* **2004**, *18*, 127–130. [CrossRef]
24. Schiuma, G.; Schettini, E.; Santarsiero, F.; Carlucci, D. The transformative leadership compass: Six competencies for digital transformation entrepreneurship. *Int. J. Entrep. Behav. Res.* **2022**, *28*, 1273–1291. [CrossRef]
25. Vogel, B.; Reichard, R.J.; Batistič, S.; Černe, M. A bibliometric review of the leadership development field: How we got here, where we are, and where we are headed. *Leadersh. Q.* **2021**, *32*, 101381. [CrossRef]
26. Amagoh, F. Leadership development and leadership effectiveness. *Manag. Decis.* **2009**, *47*, 989–999. [CrossRef]
27. Watkins, A. *Step Change: The Leader's Journey*; Routledge: London, UK, 2022.
28. Joseph-Richard, P.; McCray, J. Evaluating leadership development in a changing world? Alternative models and approaches for healthcare organisations. *Hum. Resour. Dev. Int.* **2023**, *26*, 114–150. [CrossRef]
29. Korzynski, P.; Kozminski, A.K.; Baczyńska, A.; Haenlein, M. Bounded leadership: An empirical study of leadership competencies, constraints, and effectiveness. *Eur. Manag. J.* **2021**, *39*, 226–235. [CrossRef]
30. Gerard, L.; McMillan, J.; D'Annunzio-Green, N. Conceptualising sustainable leadership. *Ind. Commer. Train.* **2017**, *49*, 116–126. [CrossRef]
31. Hatler, C.; Sturgeon, P. Resilience building: A necessary leadership competence. *Nurse Lead.* **2013**, *11*, 32–39. [CrossRef]
32. Hossain, M.U.; Asheq, A.A. Do leadership orientation and proactive personality influence social entrepreneurial intention? *Int. J. Manag. Enterp. Dev.* **2020**, *19*, 109–125. [CrossRef]
33. Samsir, S. The effect of leadership orientation on innovation and its relationship with competitive advantages of small and medium enterprises in Indonesia. *Int. J. Law Manag.* **2018**, *60*, 530–542. [CrossRef]
34. Kwiotkowska, A.; Wolniak, R.; Gajdzik, B.; Gębczyńska, M. Configurational paths of leadership competency shortages and 4.0 leadership effectiveness: An fs/QCA study. *Sustainability* **2022**, *14*, 2795. [CrossRef]
35. Behfar, K.; Okhuysen, G.A. Perspective—Discovery within validation logic: Deliberately surfacing, complementing, and substituting abductive reasoning in hypothetico-deductive inquiry. *Organ. Sci.* **2018**, *29*, 323–340. [CrossRef]

36. Hair, J.F., Jr.; Hult, G.T.M.; Ringle, C.M.; Sarstedt, M.; Danks, N.P.; Ray, S.; Hair, J.F.; Hult, G.T.M.; Ringle, C.M.; Sarstedt, M.; et al. An Introduction to Structural Equation Modeling. In *Partial Least Squares Structural Equation Modeling (PLS-SEM) Using R*; Springer Nature: Berlin/Heidelberg, Germany, 2021. Available online: [https://link.springer.com/chapter/10.1007/978-3-030-80519-7\\_1](https://link.springer.com/chapter/10.1007/978-3-030-80519-7_1) (accessed on 4 April 2024).
37. Nye, C.D.; Drasgow, F. Assessing goodness of fit: Simple rules of thumb simply do not work. *Organ. Res. Methods* **2011**, *14*, 548–570. [[CrossRef](#)]
38. Singh, R. Does my structural model represent the real phenomenon?: A review of the appropriate use of Structural Equation Modelling (SEM) model fit indices. *Mark. Rev.* **2009**, *9*, 199–212. [[CrossRef](#)]
39. Moshagen, M. The model size effect in SEM: Inflated goodness-of-fit statistics are due to the size of the covariance matrix. *Struct. Equ. Model. Multidiscip. J.* **2012**, *19*, 86–98. [[CrossRef](#)]
40. Bryant, F.B.; Satorra, A. Principles and practice of scaled difference chi-square testing. *Struct. Equ. Model. Multidiscip. J.* **2012**, *19*, 372–398. [[CrossRef](#)]
41. Taasoobshirazi, G.; Wang, S. The performance of the SRMR, RMSEA, CFI, and TLI: An examination of sample size, path size, and degrees of freedom. *J. Appl. Quant. Methods* **2016**, *11*, 31–39.
42. Sivo, S.A.; Pan, C.C.S.; Hahs-Vaughn, D.L. Combined longitudinal effects of attitude and subjective norms on student outcomes in a web-enhanced course: A structural equation modelling approach. *Br. J. Educ. Technol.* **2007**, *38*, 861–875. [[CrossRef](#)]
43. Xia, Y.; Yang, Y. RMSEA, CFI, and TLI in structural equation modeling with ordered categorical data: The story they tell depends on the estimation methods. *Behav. Res. Methods* **2019**, *51*, 409–428. [[CrossRef](#)]

**Disclaimer/Publisher’s Note:** The statements, opinions and data contained in all publications are solely those of the individual author(s) and contributor(s) and not of MDPI and/or the editor(s). MDPI and/or the editor(s) disclaim responsibility for any injury to people or property resulting from any ideas, methods, instructions or products referred to in the content.